

NGTB40N120IHLWG

IGBT

This Insulated Gate Bipolar Transistor (IGBT) features a robust and cost effective Field Stop (FS) Trench construction, and provides superior performance in demanding switching applications, offering both low on-state voltage and minimal switching loss. The IGBT is well suited for resonant or soft switching applications. Incorporated into the device is a rugged co-packaged free wheeling diode with a low forward voltage.

Features

- Low Saturation Voltage using Trench with Field Stop Technology
- Low Switching Loss Reduces System Power Dissipation
- Optimized for Low Case Temperature in IH Cooker Application
- Low Gate Charge
- These are Pb-Free Devices

Typical Applications

- Inductive Heating
- Consumer Appliances
- Soft Switching

ABSOLUTE MAXIMUM RATINGS

Rating	Symbol	Value	Unit
Collector-emitter voltage	V_{CES}	1200	V
Collector current @ $T_C = 25^\circ\text{C}$ @ $T_C = 100^\circ\text{C}$	I_C	80 40	A
Pulsed collector current, T_{pulse} limited by T_{Jmax}	I_{CM}	320	A
Diode forward current @ $T_C = 25^\circ\text{C}$ @ $T_C = 100^\circ\text{C}$	I_F	80 40	A
Diode pulsed current, T_{pulse} limited by T_{Jmax}	I_{FM}	320	A
Gate-emitter voltage	V_{GE}	± 20	V
Power Dissipation @ $T_C = 25^\circ\text{C}$ @ $T_C = 100^\circ\text{C}$	P_D	260 104	W
Operating junction temperature range	T_J	-55 to +150	$^\circ\text{C}$
Storage temperature range	T_{stg}	-55 to +150	$^\circ\text{C}$
Lead temperature for soldering, 1/8" from case for 5 seconds	T_{SLD}	260	$^\circ\text{C}$

Stresses exceeding Maximum Ratings may damage the device. Maximum Ratings are stress ratings only. Functional operation above the Recommended Operating Conditions is not implied. Extended exposure to stresses above the Recommended Operating Conditions may affect device reliability.



ON Semiconductor[®]

<http://onsemi.com>

40 A, 1200 V
 $V_{CEsat} = 1.90 \text{ V}$
 $E_{off} = 1.40 \text{ mJ}$

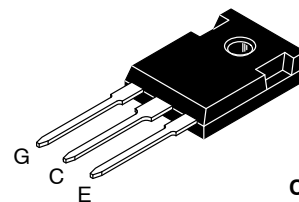

**TO-247
CASE 340L
STYLE 4**

MARKING DIAGRAM



A = Assembly Location
Y = Year
WW = Work Week
G = Pb-Free Package

ORDERING INFORMATION

Device	Package	Shipping
NGTB40N120IHLWG	TO-247 (Pb-Free)	30 Units / Rail

NGTB40N120IHLWG

THERMAL CHARACTERISTICS

Rating	Symbol	Value	Unit
Thermal resistance junction-to-case, for IGBT	$R_{\theta JC}$	0.48	$^{\circ}\text{C}/\text{W}$
Thermal resistance junction-to-case, for Diode	$R_{\theta JC}$	1.5	$^{\circ}\text{C}/\text{W}$
Thermal resistance junction-to-ambient	$R_{\theta JA}$	40	$^{\circ}\text{C}/\text{W}$

ELECTRICAL CHARACTERISTICS ($T_J = 25^{\circ}\text{C}$ unless otherwise specified)

Parameter	Test Conditions	Symbol	Min	Typ	Max	Unit
-----------	-----------------	--------	-----	-----	-----	------

STATIC CHARACTERISTIC

Collector-emitter breakdown voltage, gate-emitter short-circuited	$V_{GE} = 0\text{ V}, I_C = 500\ \mu\text{A}$	$V_{(BR)CES}$	1200	-	-	V
Collector-emitter saturation voltage	$V_{GE} = 15\text{ V}, I_C = 40\text{ A}$ $V_{GE} = 15\text{ V}, I_C = 40\text{ A}, T_J = 150^{\circ}\text{C}$	V_{CEsat}	-	1.90 2.1	2.35 -	V
Gate-emitter threshold voltage	$V_{GE} = V_{CE}, I_C = 400\ \mu\text{A}$	$V_{GE(th)}$	4.5	5.5	6.5	V
Collector-emitter cut-off current, gate-emitter short-circuited	$V_{GE} = 0\text{ V}, V_{CE} = 1200\text{ V}$ $V_{GE} = 0\text{ V}, V_{CE} = 1200\text{ V}, T_J = 150^{\circ}\text{C}$	I_{CES}	-	-	0.5 2.0	mA
Gate leakage current, collector-emitter short-circuited	$V_{GE} = 20\text{ V}, V_{CE} = 0\text{ V}$	I_{GES}	-	-	200	nA

DYNAMIC CHARACTERISTIC

Input capacitance	$V_{CE} = 20\text{ V}, V_{GE} = 0\text{ V}, f = 1\text{ MHz}$	C_{ies}	-	10400	-	pF
Output capacitance		C_{oes}	-	245	-	
Reverse transfer capacitance		C_{res}	-	185	-	
Gate charge total	$V_{CE} = 600\text{ V}, I_C = 40\text{ A}, V_{GE} = 15\text{ V}$	Q_g		420		nC
Gate to emitter charge		Q_{ge}		95		
Gate to collector charge		Q_{gc}		178		

SWITCHING CHARACTERISTIC, INDUCTIVE LOAD

Turn-off delay time	$T_J = 25^{\circ}\text{C}$ $V_{CC} = 600\text{ V}, I_C = 40\text{ A}$ $R_g = 10\ \Omega$ $V_{GE} = 0\text{ V}/15\text{ V}$	$t_{d(off)}$		360		ns
Fall time		t_f		130		
Turn-off switching loss		E_{off}		1.40		
Turn-off delay time	$T_J = 125^{\circ}\text{C}$ $V_{CC} = 600\text{ V}, I_C = 40\text{ A}$ $R_g = 10\ \Omega$ $V_{GE} = 0\text{ V}/15\text{ V}$	$t_{d(off)}$		380		ns
Fall time		t_f		185		
Turn-off switching loss		E_{off}		2.6		

DIODE CHARACTERISTIC

Forward voltage	$V_{GE} = 0\text{ V}, I_F = 40\text{ A}$ $V_{GE} = 0\text{ V}, I_F = 40\text{ A}, T_J = 150^{\circ}\text{C}$	V_F		1.6 1.8	1.8	V
-----------------	---	-------	--	------------	-----	---

NGTB40N120IHLWG

TYPICAL CHARACTERISTICS

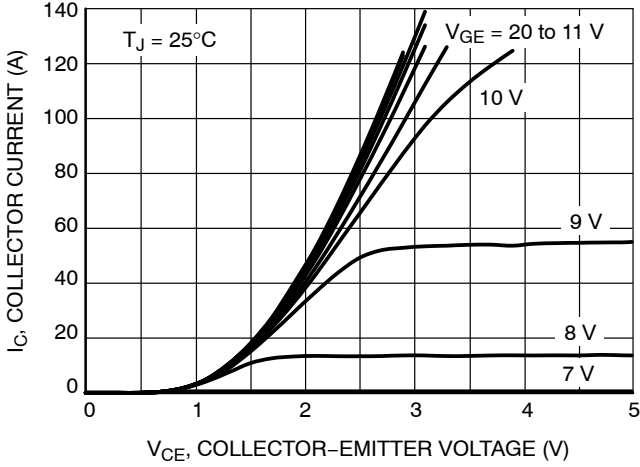

Figure 1. Output Characteristics

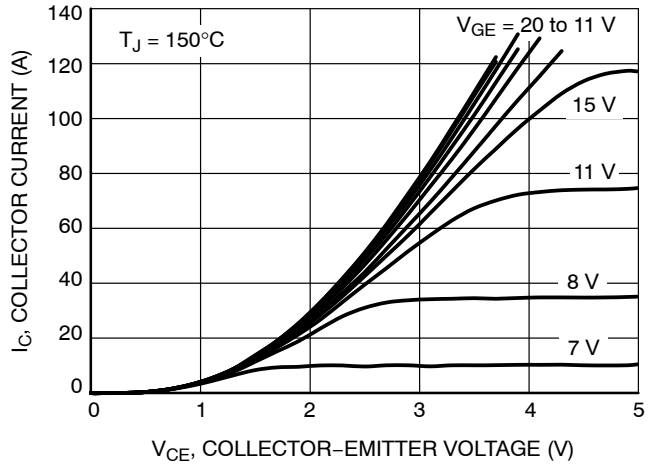

Figure 2. Output Characteristics

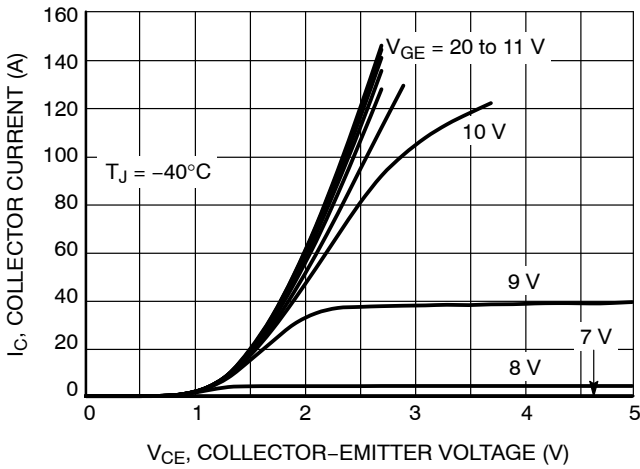

Figure 3. Output Characteristics

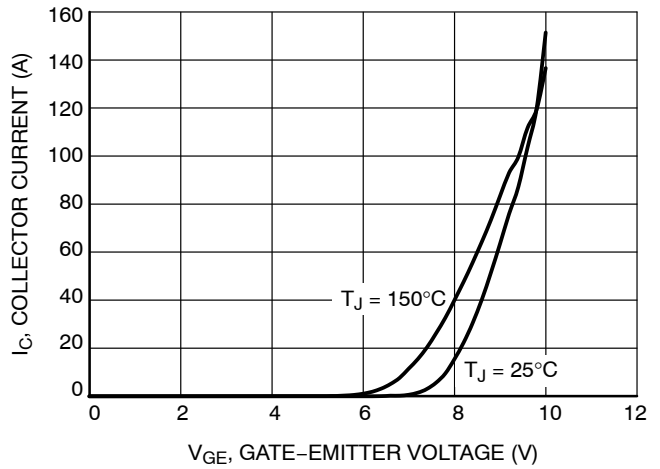

Figure 4. Typical Transfer Characteristics

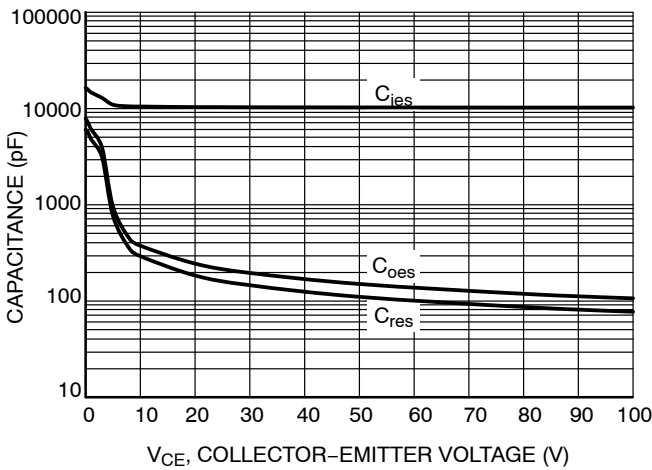

Figure 5. Typical Capacitance

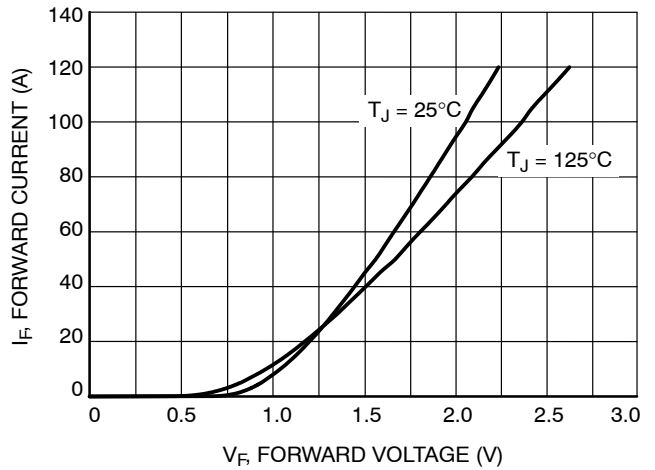

Figure 6. Diode Forward Characteristics

NGTB40N120IHLWG

TYPICAL CHARACTERISTICS

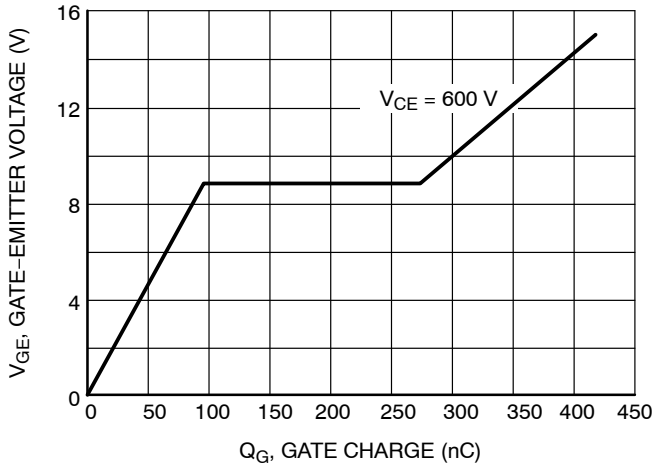

Figure 7. Typical Gate Charge

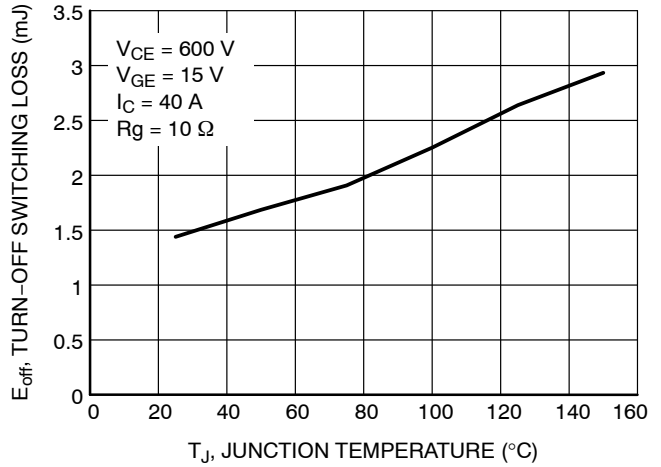

Figure 8. Energy Loss vs. Temperature

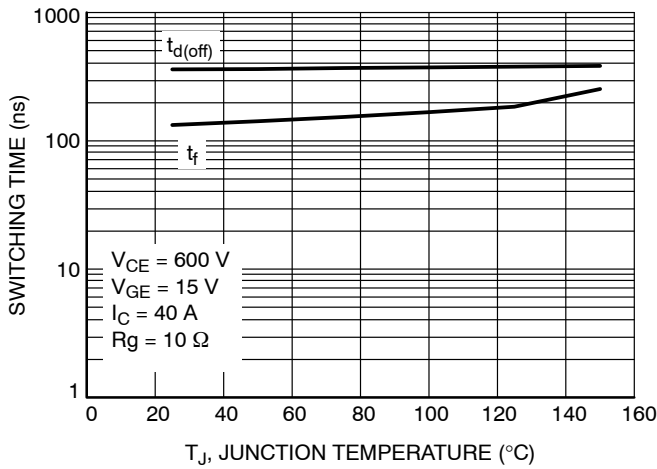

Figure 9. Switching Time vs. Temperature

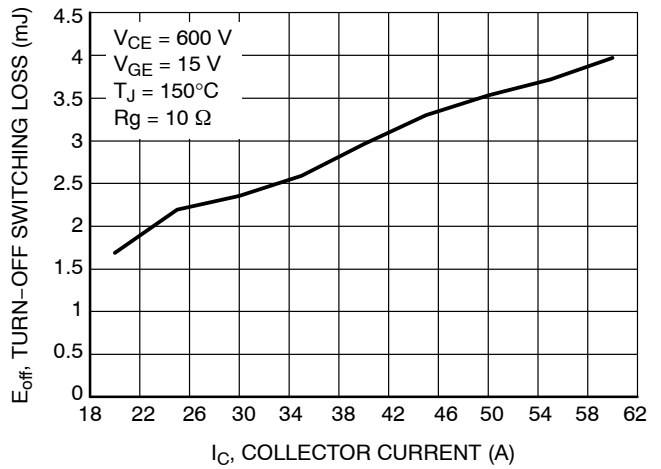

Figure 10. Energy Loss vs. I_C

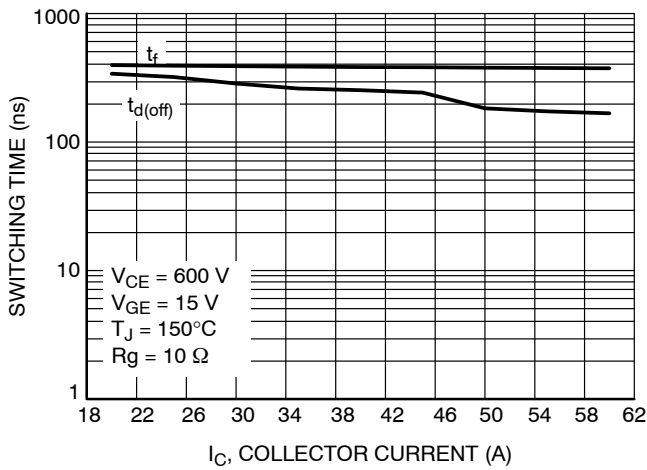

Figure 11. Switching Time vs. I_C

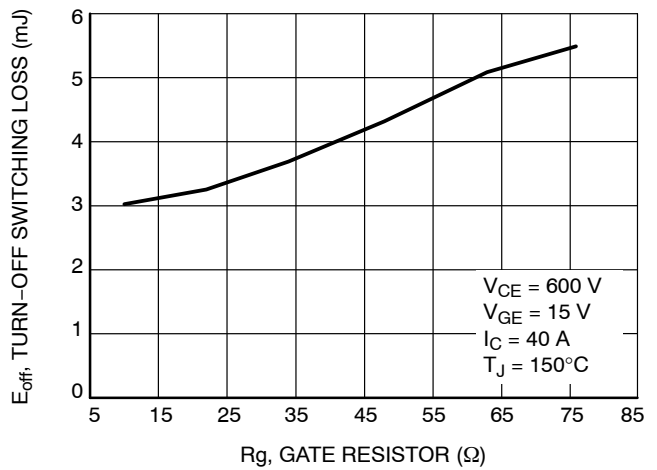

Figure 12. Energy Loss vs. R_g

NGTB40N120IHLWG

TYPICAL CHARACTERISTICS

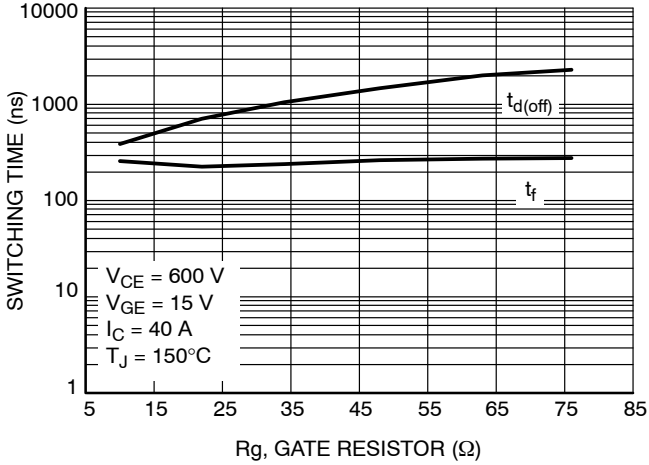

Figure 13. Switching Time vs. R_g

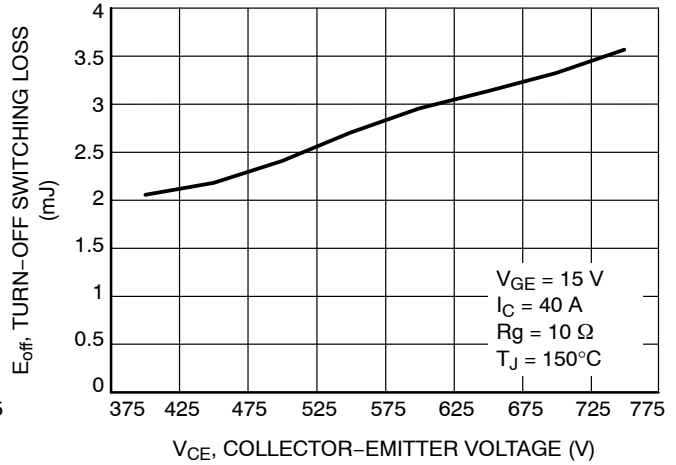

Figure 14. Energy Loss vs. V_{CE}

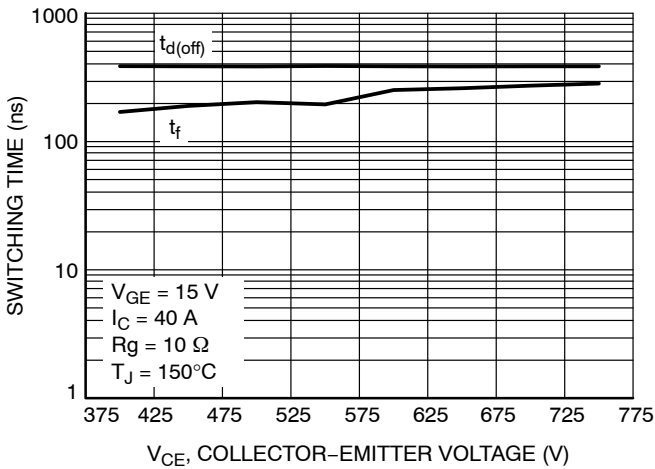

Figure 15. Switching Time vs. V_{CE}

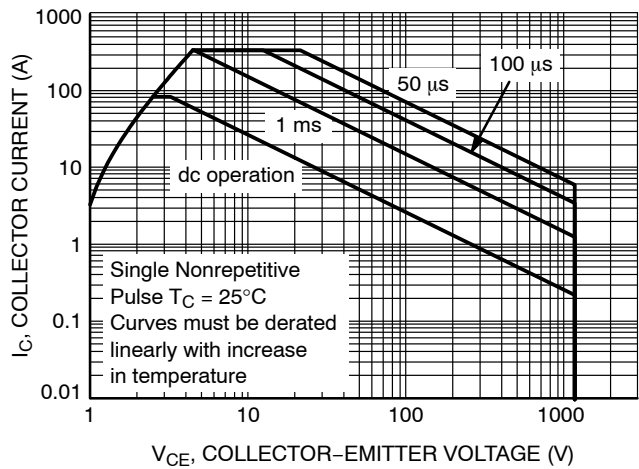

Figure 16. Safe Operating Area

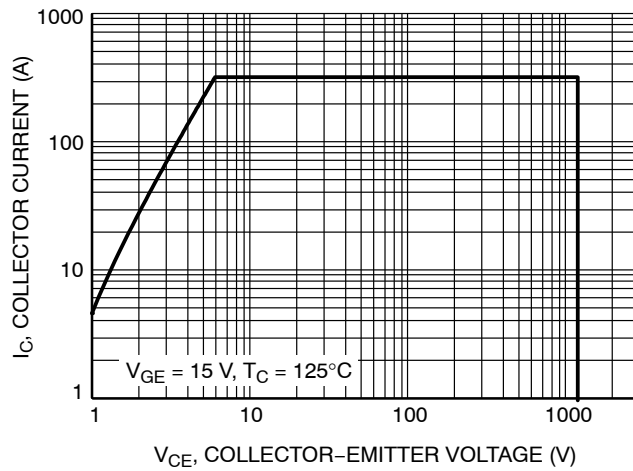

Figure 17. Reverse Bias Safe Operating Area

NGTB40N120IHLWG

TYPICAL CHARACTERISTICS

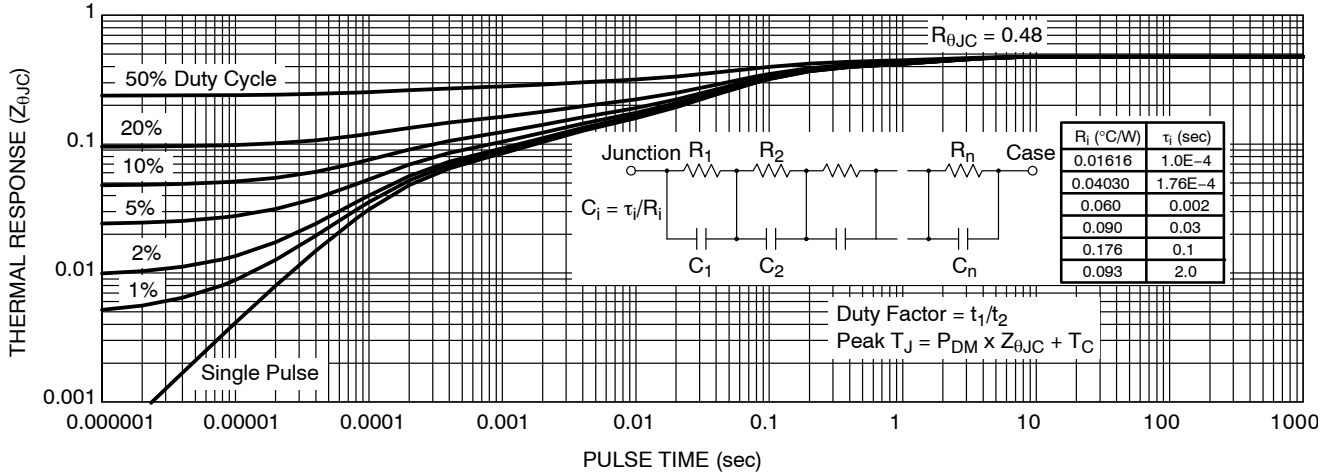

Figure 18. IGBT Transient Thermal Impedance

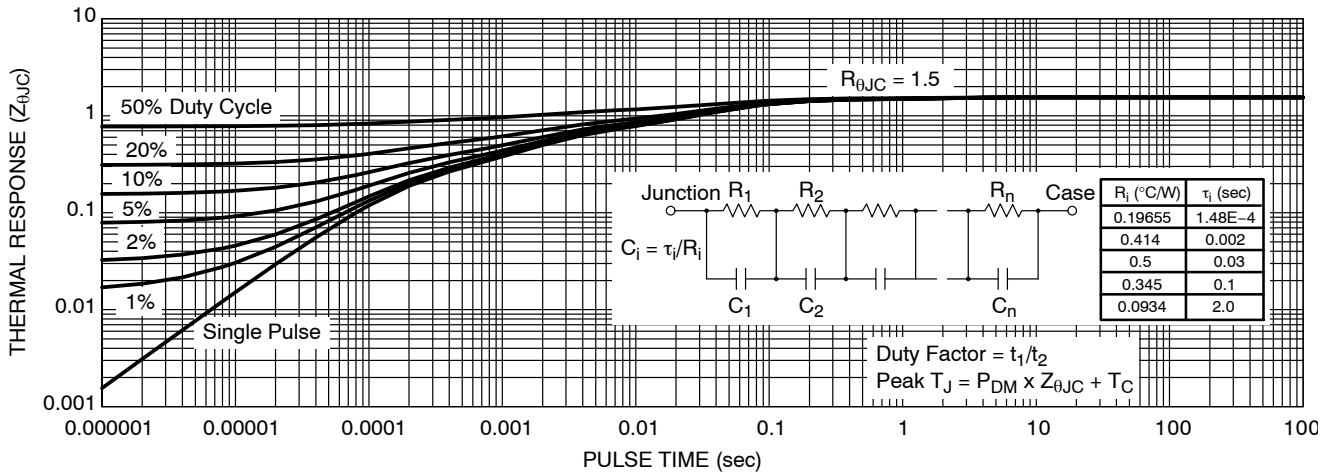

Figure 19. Diode Transient Thermal Impedance

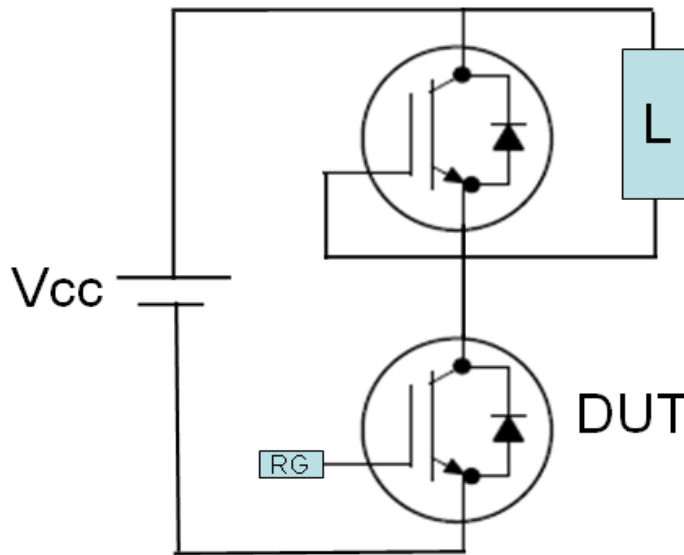

Figure 20. Test Circuit for Switching Characteristics

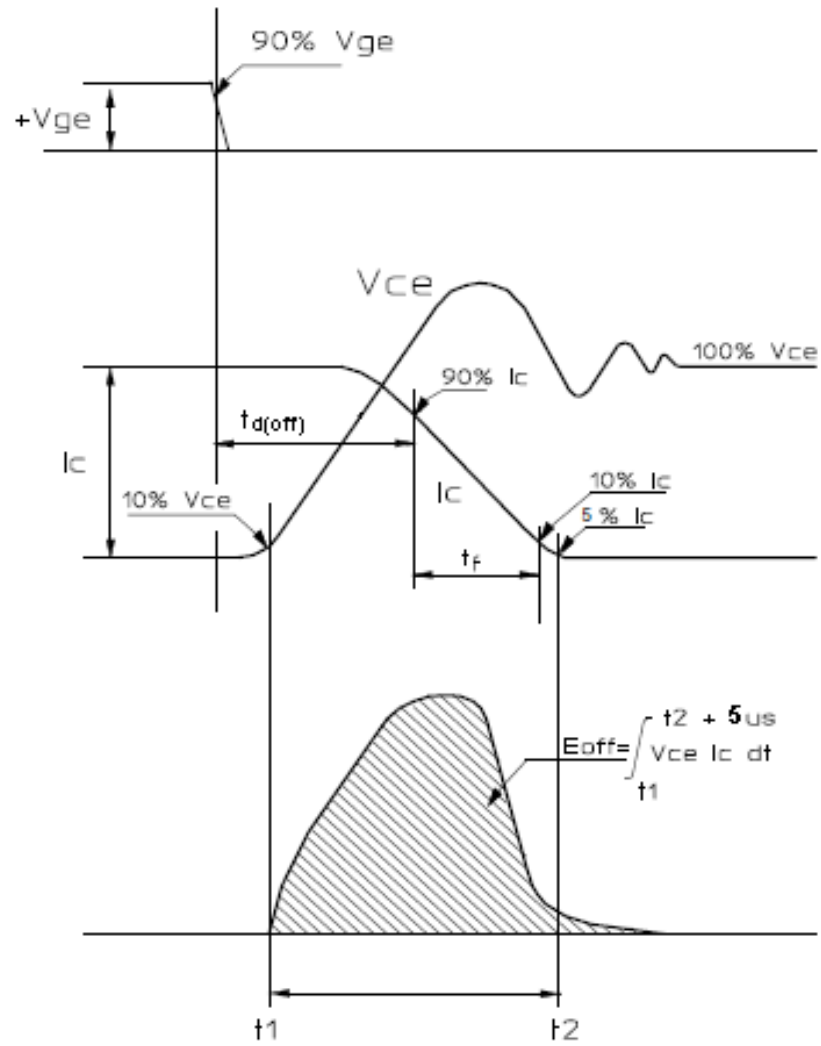
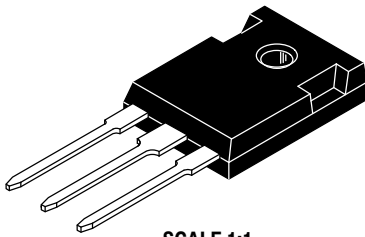

Figure 21. Definition of Turn Off Waveform

MECHANICAL CASE OUTLINE PACKAGE DIMENSIONS

ON Semiconductor®



TO-247
CASE 340L-02
ISSUE F

DATE 26 OCT 2011

SCALE 1:1

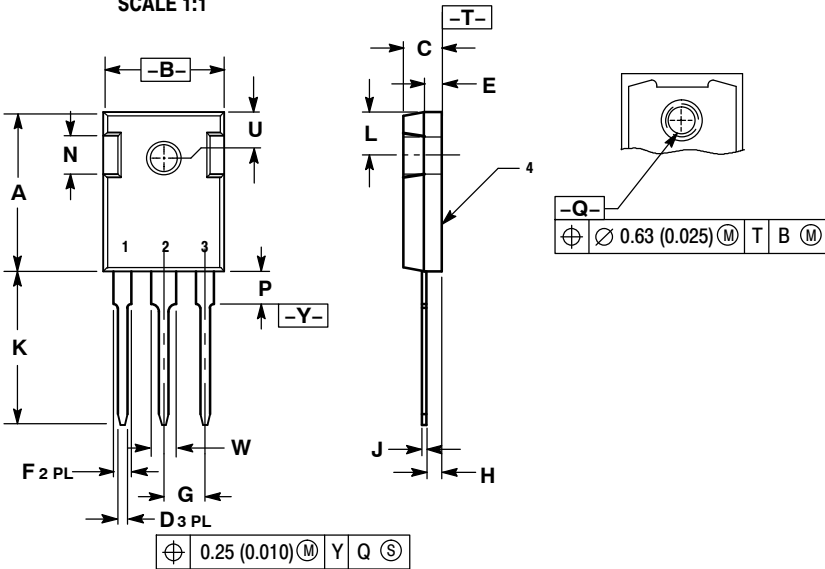

- NOTES:
1. DIMENSIONING AND TOLERANCING PER ANSI Y14.5M, 1982.
2. CONTROLLING DIMENSION: MILLIMETER.

DIM	MILLIMETERS		INCHES	
	MIN	MAX	MIN	MAX
A	20.32	21.08	0.800	0.830
B	15.75	16.26	0.620	0.640
C	4.70	5.30	0.185	0.209
D	1.00	1.40	0.040	0.055
E	1.90	2.60	0.075	0.102
F	1.65	2.13	0.065	0.084
G	5.45 BSC		0.215 BSC	
H	1.50	2.49	0.059	0.098
J	0.40	0.80	0.016	0.031
K	19.81	20.83	0.780	0.820
L	5.40	6.20	0.212	0.244
N	4.32	5.49	0.170	0.216
P	---	4.50	---	0.177
Q	3.55	3.65	0.140	0.144
U	6.15 BSC		0.242 BSC	
W	2.87	3.12	0.113	0.123

GENERIC MARKING DIAGRAM*

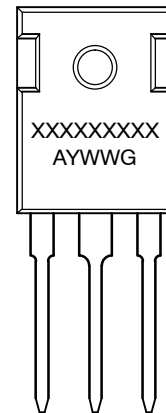

XXXXXX = Specific Device Code
A = Assembly Location
Y = Year
WW = Work Week
G = Pb-Free Package

- STYLE 1:
PIN 1. GATE
2. DRAIN
3. SOURCE
4. DRAIN
- STYLE 2:
PIN 1. ANODE
2. CATHODE (S)
3. ANODE 2
4. CATHODES (S)
- STYLE 3:
PIN 1. BASE
2. COLLECTOR
3. EMITTER
4. COLLECTOR
- STYLE 4:
PIN 1. GATE
2. COLLECTOR
3. EMITTER
4. COLLECTOR
- STYLE 5:
PIN 1. CATHODE
2. ANODE
3. GATE
4. ANODE
- STYLE 6:
PIN 1. MAIN TERMINAL 1
2. MAIN TERMINAL 2
3. GATE
4. MAIN TERMINAL 2

*This information is generic. Please refer to device data sheet for actual part marking. Pb-Free indicator, "G" or microdot "▪", may or may not be present.

DOCUMENT NUMBER:	98ASB15080C	Electronic versions are uncontrolled except when accessed directly from the Document Repository. Printed versions are uncontrolled except when stamped "CONTROLLED COPY" in red.
STATUS:	ON SEMICONDUCTOR STANDARD	
NEW STANDARD:		
DESCRIPTION:	TO-247	PAGE 1 OF 2

ON Semiconductor and  are trademarks of Semiconductor Components Industries, LLC dba ON Semiconductor or its subsidiaries in the United States and/or other countries. ON Semiconductor owns the rights to a number of patents, trademarks, copyrights, trade secrets, and other intellectual property. A listing of ON Semiconductor's product/patent coverage may be accessed at www.onsemi.com/site/pdf/Patent-Marking.pdf. ON Semiconductor reserves the right to make changes without further notice to any products herein. ON Semiconductor makes no warranty, representation or guarantee regarding the suitability of its products for any particular purpose, nor does ON Semiconductor assume any liability arising out of the application or use of any product or circuit, and specifically disclaims any and all liability, including without limitation special, consequential or incidental damages. Buyer is responsible for its products and applications using ON Semiconductor products, including compliance with all laws, regulations and safety requirements or standards, regardless of any support or applications information provided by ON Semiconductor. "Typical" parameters which may be provided in ON Semiconductor data sheets and/or specifications can and do vary in different applications and actual performance may vary over time. All operating parameters, including "Typicals" must be validated for each customer application by customer's technical experts. ON Semiconductor does not convey any license under its patent rights nor the rights of others. ON Semiconductor products are not designed, intended, or authorized for use as a critical component in life support systems or any FDA Class 3 medical devices or medical devices with a same or similar classification in a foreign jurisdiction or any devices intended for implantation in the human body. Should Buyer purchase or use ON Semiconductor products for any such unintended or unauthorized application, Buyer shall indemnify and hold ON Semiconductor and its officers, employees, subsidiaries, affiliates, and distributors harmless against all claims, costs, damages, and expenses, and reasonable attorney fees arising out of, directly or indirectly, any claim of personal injury or death associated with such unintended or unauthorized use, even if such claim alleges that ON Semiconductor was negligent regarding the design or manufacture of the part. ON Semiconductor is an Equal Opportunity/Affirmative Action Employer. This literature is subject to all applicable copyright laws and is not for resale in any manner.

PUBLICATION ORDERING INFORMATION

LITERATURE FULFILLMENT:

Email Requests to: orderlit@onsemi.com

ON Semiconductor Website: www.onsemi.com

TECHNICAL SUPPORT

North American Technical Support:
Voice Mail: 1 800-282-9855 Toll Free USA/Canada
Phone: 011 421 33 790 2910

Europe, Middle East and Africa Technical Support:

Phone: 00421 33 790 2910

For additional information, please contact your local Sales Representative