

SERVICE MANUAL & PARTS LIST (without price)

EX-S770

AUG. 2006

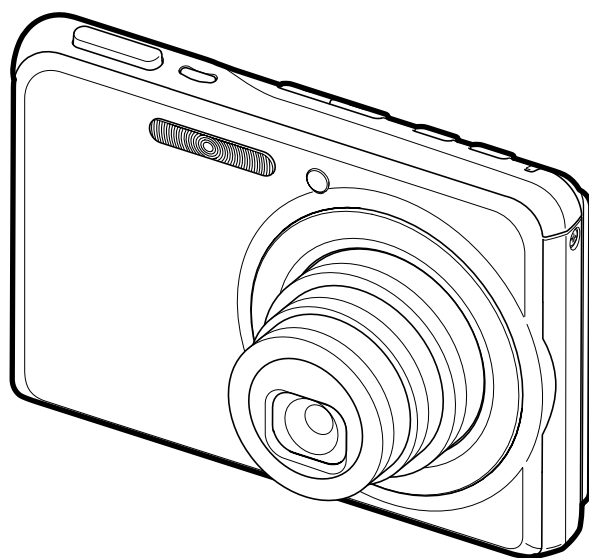

CASIO®

Ver.2 : Oct. 2006

CONTENTS

SPECIFICATIONS	1
BLOCK DIAGRAM	5
TEST MODE	6
PROGRAM VERSION UPGRADING	7
1. To update the firmware version	7
2. How to restore the firmware	8
3. To install the firmware	9
ADJ TOOL	10
1. Preparation	10
2. How to use ADJ Tool when replacing Lens unit	12
3. How to use ADJ Tool when replacing MAIN PCB	13
VCOM DC ADJUSTMENT	14
CURRENT CONSUMPTION	17
THE COUNTERMEASURE FOR "SYSTEM ERROR"	17
RESETTING THE PLACE OF DESTINATION	18
DISASSEMBLY	19
ASSEMBLY	28
EXPLODED VIEW	37
PARTS LIST	38
PRINTED CIRCUIT BOARDS	40
SCHEMATIC DIAGRAMS	42

SPECIFICATIONS

Image Files Format	Snapshots: JPEG (Exif Ver.2.2); DCF (Design Rule for Camera File System) 1.0 standard; DPOF compliant Movies: MPEG-4 AVI format Audio: WAV
Recording Media	Built-in Memory 6.0 MB, SDHC Memory Card, SD Memory Card, MMC (MultiMediaCard), MMCplus (MultiMediaCardplus)

Approximate Memory Capacity and File sizes

• Snapshots

Image Size (pixels)	Image Quality	Approximate Image File Size	Approximate Built-in Memory (6.0MB) Capacity	Approximate SD Memory Card* (256MB) Capacity
7M 3072 x 2304	Fine	4.32 MB	1 image	55 images
	Normal	2.1 MB	2 images	110 images
	Economy	1.44 MB	3 images	158 images
3:2 3072 x 2048	Fine	3.84 MB	1 image	61 images
	Normal	2.0 MB	2 images	116 images
	Economy	1.28 MB	4 images	176 images
16:9 3072 x 1728	Fine	3.24 MB	1 image	73 images
	Normal	1.9 MB	2 images	121 images
	Economy	1.08 MB	5 images	206 images
5M 2560 x 1920	Fine	3.0 MB	1 image	78 images
	Normal	1.8 MB	3 images	128 images
	Economy	1.0 MB	5 images	221 images
3M 2048 x 1536	Fine	1.92 MB	2 images	121 images
	Normal	1.28 MB	4 images	180 images
	Economy	640 KB	8 images	348 images
2M 1600 x 1200	Fine	1.17 MB	4 images	196 images
	Normal	780 KB	7 images	286 images
	Economy	390 KB	12 images	530 images
VGA 640 x 480 (VGA)	Fine	360 KB	15 images	625 images
	Normal	240 KB	22 images	937 images
	Economy	120 KB	40 images	1739 images

• Movies

Image Quality (Pixels)	Maximum Recording Time Per File	Approximate Data Rate (Frame Rate)	Approximate Built-in Memory (6.0MB) Capacity	Approximate SD Memory Card* (256MB) Capacity
HQ 640 x 480	Until memory full	40 Megabits / second (30 frames / second)	8 seconds	8 minutes, 17 seconds
HQ Wide 704 x 384	Until memory full	40 Megabits / second (30 frames / second)	8 seconds	8 minutes, 17 seconds
Normal 640 x 480	Until memory full	2.1 Megabits / second (30 frames / second)	15 seconds	15 minutes, 44 seconds
Normal Wide 704 x 384	Until memory full	2.1 Megabits / second (30 frames / second)	15 seconds	15 minutes, 44 seconds
LP 320 x 240	Until memory full	745 Kilobits / second (15 frames / second)	42 seconds	43 minutes, 54 seconds

* Number of image values are approximate and are provided for reference only.

* Based on Matsushita Electric Industrial Co., Ltd. products.

The number of images you can save depends on the type of memory card you are using.

* When using a memory card with a different capacity, calculate the number of images as a percentage of 256 MB.

Delete	1 file; all files (with memory protection feature)
Effective Pixels	7.2 million
Imaging Element	1/2.5 square pixel primary color CCD (Total pixels: 7.41 million)
Lens/Focal Distance	F2.7 to 5.2/f=6.2 to 18.6 mm (Equivalent to 38 to 114 mm on a 35 mm film camera.) Six lenses in five groups, including aspherical lens.
Zoom	3X optical zoom / 4X digital zoom (Image Size: 7M (3072 x 2304 pixels)) (12X total zoom)
Focusing Focus Modes AF Area	Contrast Detection Auto Focus Auto Focus, Macro Focus, Pan Focus (movie recording only), Infinity Mode, Manual Focus Spot or Multi; with AF assist lamp
Approximate Focus Range (from lens surface)	Auto Focus : 40cm to ∞ (1.3' to ∞) Macro Focus : 15cm to 50cm (5.9" to 19.7") Infinity Mode : ∞ Manual Focus : 15cm to ∞ (5.9" to ∞) Range is affected by optical zoom.
Exposure Control	Metering : Multi-pattern, center-weighted, and spot by imaging element Exposure: Program AE Exposure Compensation : -2EV to +2EV (1/3EV units)
Shutter	CCD shutter; mechanical shutter Snapshot (Auto) : 1/2 to 1/2000 second Snapshot (Night Scene) : 4 to 1/2000 second Snapshot (Fireworks) : 2 seconds (fixed)
Aperture Value	F2.7/4.3, auto switching * Using optical zoom causes the aperture to change.
White Balance	Auto, fixed (6 modes), manual
Sensitivity	Snapshots (Standard) : Auto, ISO 50, ISO 100, ISO 200, ISO 400 • Maximum sensitivity is ISO 800 when the BEST SHOT Anti Shake or High Sensitivity scene is being used. Movies : Auto
Self-timer	Trigger Times : 10 seconds, 2 seconds, Triple Self-timer
Built-in Flash Flash Modes Approximate Flash Range	Auto, Off, On, Soft Flash, Red-eye reduction Flash Range: Wide Angle Optical Zoom : 0.15 to 3.9 meters (0.5' to 12.8') Telephoto Optical Zoom : 0.4 to 2.0 meters (1.3' to 6.6') • Flash Continuous Shutter Wide Angle Optical Zoom : 0.26 to 1.68 meters (0.9' to 5.5') Telephoto Optical Zoom : 0.4 to 0.87 meters (1.3' to 2.9') * ISO Sensitivity: "Auto" * Depends on zoom factor.
Recording	Snapshots (with audio); Macro; Self-timer; Continuous Shutter; BEST SHOT (scenes other than Short Movie, Past Movie, and Voice Recording); movie with audio (Movie, Short Movie, Past Movie); audio (Voice Recording) * Audio is monaural.
Approximate Audio Recording Times	Audio Snapshot : 30 seconds per image After Recording : 30 seconds per image Voice Recording : 18 minutes (when using built-in memory)
Monitor Screen	2.8-inch Wide TFT color LCD, 230,400 pixels (960 × 240) pixels
Viewfinder	Monitor screen
Timekeeping Functions	Built-in quartz digital clock Date and Time : Recorded with image data, Time stamp Auto Calendar : To 2049
World Time	162 cities in 32 time zones, City name, date, time, summer time
Input/Output Terminals	Cradle contact
USB	USB 2.0 Hi-Speed compatible
Microphone	Monaural
Speaker	Monaural

Power Requirements

Power Requirements Lithium ion rechargeable battery
(NP-20) x 1

Approximate Battery Life:

The values below indicate the amount of time under the conditions defined below, until power automatically turns off due to battery failure. They do not guarantee that you will be able to achieve this level of operation. Low temperatures shorten battery life.

Operation	Apporoximate Battery Life
Number of Shots (CIPA)*1	200 shots
Continuous Playback (Snapshot)*2	290 minutes
Continuous Movie Recording	90 minutes
Continuous Voice Recording*3	400 minutes

- Battery: NP-20 (Rated Capacity: 700 mAh)
- Recording Medium: SD Memory Card
- Measurement Conditions

*1 Number of Shots (CIPA)

In accordance with CIPA standards

Normal temperature (23°C (73° F)), monitor on, zoom operation between full wide and full telephoto every 30 seconds, during which two images are shot with flash; power turned off and back on every time 10 images are shot.

*2 Continuous Playback Time

Standard temperature (23°C (73° F)), one-image scroll approximately every 10 seconds

*3 Approximate continuous recording time

- The above values are based a new battery, starting from a full charge. Repeated charging shortens battery life.
- Frequency of flash, zoom, and Auto Focus usage, and the time the camera is on greatly affects recording time and number of shots values.

Power Consumption	3.7V DC Approximately 4.3W
Dimensions	94.5(W) × 60.4(H) × 17.3(D) mm (3.7"(W) × 2.4"(H) × 0.7"(D)) (Excluding projections; 13.7 mm (0.5") at thinnest part)
Weight	Approximately 127 g (4.5 oz) (excluding battery and bundled accessories)
Bundled Accessories	Rechargeable Lithium Ion Battery (NP-20); USB Cradle (CA-24); Special AC Adaptor (AD-C52S)/ AC Power Cord; USB Cable; AV Cable; Strap; CD-ROM (2); Basic Reference

Rechargeable Lithium Ion Battery (NP-20)

Rated Voltage	3.7 V
Rated Capacitance	700 mAh
Operating Temperature Range	0 to 40°C (32 to 104°F)
Dimensions	33.0 (W) × 50.0 (H) × 4.7 (D) mm (1.3"(W) × 2.0"(H) × 0.19"(D))
Weight	Approximately 16 g (0.56 oz)

USB Cradle (CA-34)

Input/Output Terminals	Camera contact; USB port; external power supply terminal (DC IN 5.3 V); AV terminal (AV OUT: NTSC/PAL standards)
Power Consumption	5.3V DC Approximately 3.2W
Dimensions	109(W) × 24(H) × 58(D) mm (4.3"(W) × 0.9"(H) × 2.3"(D)) (Excluding projections)
Weight	Approximately 47 g (1.7 oz)

Special AC Adaptor (Inlet Type) (AD-C52S)

Input Power	100 to 240V AC, 50/60Hz, 90mA
Output Power	5.3V DC, 650mA
Dimensions	63(W) × 20(H) × 50(D) mm (2.5"(W) × 0.8"(H) × 2.0"(D)) (excluding projections and cable)
Weight	Approximately 76 g (2.7 oz)

Power Supply

- Use only the special NP-20 rechargeable lithium ion battery to power this camera. Use of any other type of battery is not supported.
- This camera does not have a separate battery for the clock. The date and time will reset whenever the camera is not supplied power by the battery and/or the USB cradle for about 30 hours. Be sure to reconfigure these settings after power is interrupted.

LCD Panel

- The LCD panel is a product of the latest LCD manufacturing technology that provides a pixel yield of 99.99%. This means that less than 0.01% of the total pixels are defective (they do not turn on or always remain turned on).

Lens

- You may sometimes notice some distortion in certain types of images, such as a slight bend in lines that should be straight. This is due to the characteristics of lens, and does not indicate malfunction of the camera.

Special AC Adaptor

- Power cord precautions for use in Singapore
The power cord set is not supplied. The power cord used must comply with relevant national and/or international standards.

BLOCK DIAGRAM

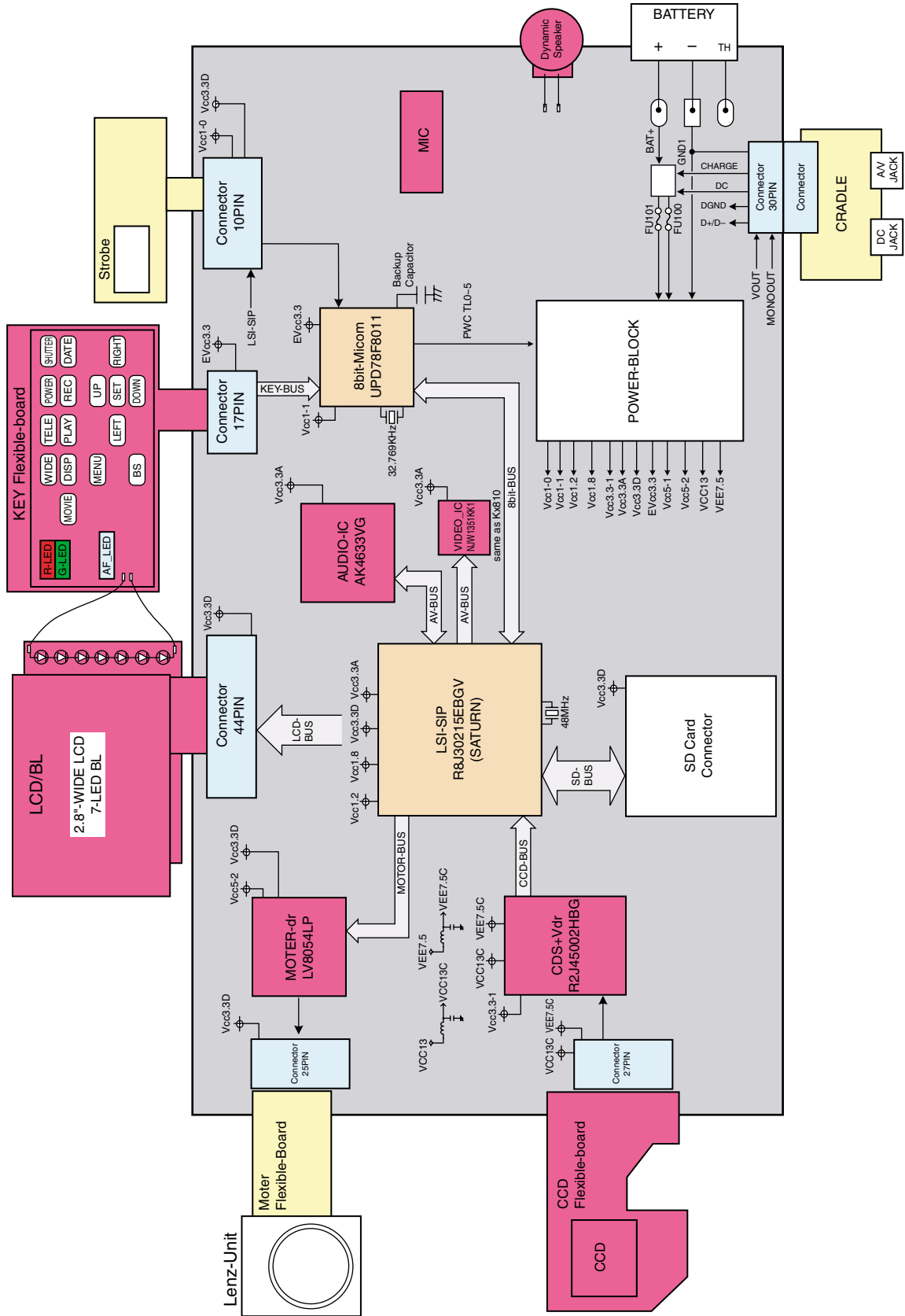

TEST MODE

Note: Never perform the menu items unless otherwise instructed. Doing so may cause destruction of the data inside, which will make the camera unusable.

■ To boot the test mode

1. While firmly pressing down both [BS], [PW ON] and [UPPER], turn the power on.

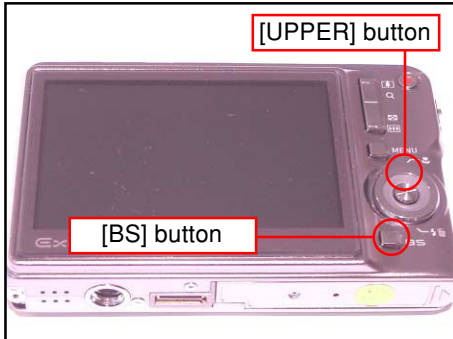

2. After the version appears, press buttons in the order of [DOWN], [DOWN], [BS] and [MENU] in 0.5 second. The diagnostic menu appears.

```
++ KX837 ++  
Ver 1.01
```

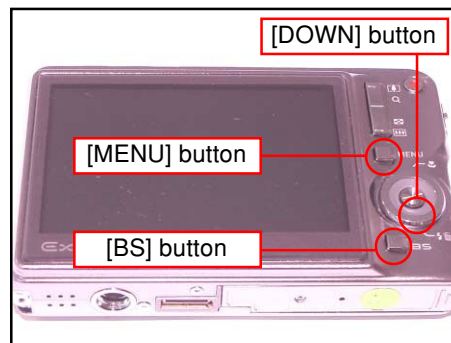

"DOWN" button -> "DOWN" button -> "BS" button -> "MENU" button

```
1 :VERSION INFO  
* 2 :USB TCC TEST  
3 :ROM UPDATE  
4 :LAST MEMORY  
5 :FORMAT
```

"SET" button

```
* 1 :USB TCC ON  
2 :USB TCC OFF  
3 :USB STORAGE  
4 :USB SPEED
```

"MENU" button

PROGRAM VERSION UPGRADING

1. To update the firmware version

1. Prepare the memory card which contains the firmware for EX-S770 in the root directory.
EX-S770.bin
2. Insert the above memory card into the camera, and set a fully charged battery in the camera.
3. Press the [power button] while holding [MENU] depressed. Keep holding [MENU] depressed until "PROGRAM UPDATE" appears in the display.
 - The following appears.
 - The version of the firmware in the memory card appears at the bottom of the display.

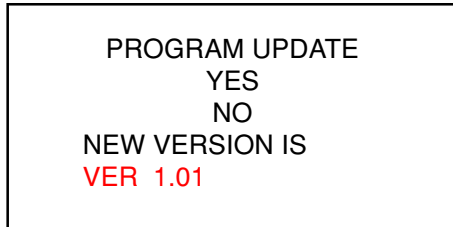

(As of **October** 2006)

NOTE 1) When a wrong software is mistakenly used, the message below appears. Update the firmware again with the correct software.

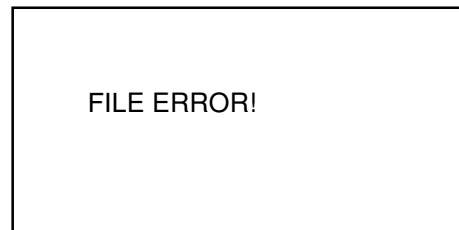

NOTE 2) When only the version appears in the display even though you are trying to operate the camera, charge the battery to the fullest and try again. The level of the battery indicator should be highest in order to update the firmware.

4. Align the white cursor to [YES] by [UPPER] and [DOWN], and then press [SET].
 - "NOW LOADING" appears in the display and the update starts.
5. "COMPLETE" appears after the update finishes.
6. Remove the memory card after turning the power off once. Turn the power back on again while holding [MENU] depressed, and check the version.
 - "VER.1.01" appears.

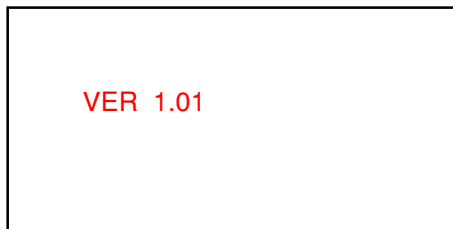

(As of **October** 2006)

7. If the version is correct, turn the power off.
8. Finally, check the operation by recording, playing back and deleting an image.

2. How to restore the firmware

1. Prepare the firmware restoration program and change its name as follows;

`rom837-gm09.lbn` → `saturn.bin`

NOTE: This software and procedure automatically restores the firmware even if the firmware belongs to a wrong model code. Make sure to use the correct software for the correct model.

2. Copy the above file to the root directory in the memory card.
3. Insert the memory card into the camera.
4. Set a fully charged battery in the camera.

NOTE: This software and procedure automatically restores the firmware even if the battery capacity of the camera is low. Make sure to use a fully charged battery to prevent the danger of power down during firmware restoration.

5. Turn the power on while pressing the [shutter release] button.

If the power does not turn on only by pressing the power button, insert the battery while holding the [shutter release] button depressed.

• The LED next to the optical viewfinder changes from “green/red blinking”, “green blinking” to “green steady”.

NOTE: This software and procedure automatically restores the firmware even if the firmware belongs to a wrong model code. Make sure to use the correct software for the correct mode.

6. When the LED becomes “green steady”, the firmware restoration is finished.

Remove the battery and the memory card, and then turn the power off.

7. Turn the power on again while holding [BS] and [UPPER] depressed.

Check the model name and the program version (PR:) in the opening screen of the test menu.

++KX837++

Ver 1.01

8. If the model name and the program version are correct, perform SYSTEM INITIAL to initialize the system area.

“BS + UPPER + PW ON” → “DOWN, DOWN, BS, MENU” → “3:ROM UPDATE” → “5:SYSTEM INITIAL”

NOTE: After SYSTEM INITIAL is performed, “SYSTEM ERROR” appears when the power is turned on again.

9. Write the latest firmware. (Refer to page 6)

After the firmware is written, check the model name and the program version (PR:) in the opening screen of the test menu.

10. Finally, start the camera normally to check the operation by recording, playing back and deleting an image. Check also that the colors in the images are not too bright or too dark.

3. To install the firmware

Initially, firmware is not installed in the PCB supplied by the parts center.

Install the firmware into the PCB after replacing with a new one as shown in the procedures below.

Note: The camera does not operate (only LED becomes “green blinking”) if the firmware is not installed in the PCB.

<Writing the restoration program 1>

1. Copy the following software to the root directly of the SD card.

Restoration software: **rom837-gm09.lbn**

Firmware: EX-S770.bin

2. Change the name as follows;

“**rom837-gm09.lbn**” to “saturn.bin”

3. Insert the SD card into the camera.

4. Insert the battery while holding the [shutter release] button depressed.

The LED next to the optical viewfinder changes from “green/red blinking”, “green blinking” to “green steady”.

5. When the LED becomes “green steady”, remove the battery and turn the power off.

<System Initialize>

1. Boot the test mode.

2. Press [DOWN] twice and then press [BS], [MENU].

3. Select “3: ROM UPDATE” and then press [SET].

4. Select “5: SYSTEM INITIALIZE” and then press [SET].

5. When the following message appears, press [SET].

SYSTEM INITIALIZE

START....

PUSH OK KEY?

6. The system initialize is executed. Turn off the power when “SUCCESS” appears.

* “SYSTEM ERROR” appears when the camera is turned off without system initialize.

<Writing the firmware>

1. Turn the power on while holding [MENU] depressed.

2. When “PROGRAM UPDATE” appears, select “YES” and then press [SET].

3. “NOW LOADING” appears while the firmware is updated.

4. When “COMPLETE” appears, the firmware update is complete.

5. Turn the power on and off to check if the camera normally functions. If there is no problem, the firmware update is successful.

ADJ TOOL

■ Introduction

Make sure to perform the adjustment by the USB ADJ Tool “adj03SSAW.exe” when replacing the lens unit or the PCB.

Here the necessary software, driver and setting are explained to use “adj03SSAW.exe”.

Note that the tool, drivers etc. are available only for Windows.

1. Preparation

1-1. Prepare the necessary software, driver and DLL file.

1) Prepare the following three files.

- Testmode driver

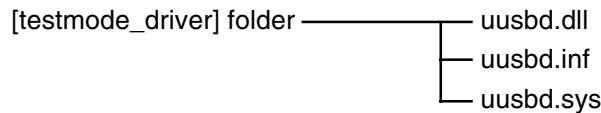

* testmode_driver_2.0] is for Windows except Windows98.

* [testmode_driver] is for Windows98 only.

- ADJ tool, USB DLL and ADJ setting file

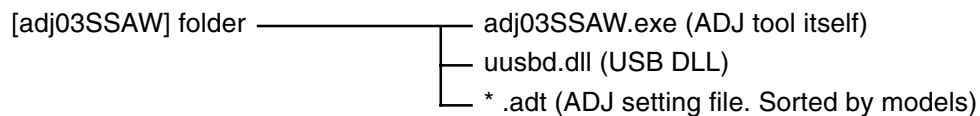

2) Place the testmode driver in an appropriate place.

3) Place all of ADJ tool, USB DLL and ADJ setting file in the same folder.

1-2. Set the camera so that it recognizes the USB test mode.

1) Enter the test menu.

Turn the power on while pressing both [BS] and [UPPER].

Press [DOWN], [DOWN], [BS] and [MENU].

2) Move the cursor to “2: USB TCC TEST” and press [SET].

3) Move the cursor to “1: USB TCC ON” and press [RIGHT], [RIGHT] and [SET].

4) USB TCC ON is now active. Turn the power off.

5) The test menu appears first when the camera power is turned on.

* When changing the USB TCC ON to OFF, set “2: USB TCC OFF” in the test menu.

1-3. Install the USB driver for the USB test mode in the computer.

(The following is an example using the Windows Me.)

1) Prepare the USB driver for the USB test mode.

2) Turn the camera power on which is set in the USB test mode as shown in 1-2 and let it enter the USB test mode directly (the test menu appears right after the power is turned on).

3) Connect the camera in the above status to the computer by the USB cable.

4) The “Add new hardware” wizard appears.

5) Check “Designate the place for the driver (for users with sufficient knowledge)” and press “Next”.

6) Check “Search for the optimum driver for the device (recommended)”.

- 7) Check "Designate the place to search", designate the place which contains "inf" file in the driver by pressing "Reference" button, and then press "Next" button.
- 8) When "Universal USB Driver (VMEM manufacturer's name)" appears upon message "Searching for the driver file for the following devices", press "Next" button.
- 9) The file copy starts.
(If a message "uusbd.inf cannot be found" appears during the file copy, designate the same place as in the step 7).
- 10) Press "Complete" button.
- 11) Right-click "My computer", select "property", and then open "Device manager".
If "Universal USB Driver (VMEM manufacturer's name)", "USB device for UUSBBD" can be found, the computer has successfully recognized the driver.
- 12) Installing the test driver into either one enables the other one to recognize it.
 - * How to uninstall the USB driver for the USB test mode
 - Connect the camera to the computer while in the USB test mode so that the computer recognizes the camera.
 - Right-click "My computer", select "Property" and open "Device manager".
 - Select "USB device for UUSBBD", and then "Universal USB Driver (VMEM manufacturer's name)".
 - Press "Delete" button to delete the driver.
 - When using Windows98/98SE/Me, delete the following three files;
(NOTE! Do NOT delete "usbd.inf" and "usbd.sys", whose names are much alike the following.)
C:windows / inf / uusbd.inf
C:windows / inf / other / KashiwanoUUSBBD.inf
C:windows / system32 / drivers / uusbd.sys
 - The driver has been successfully deleted.

1-4. Use the USB ADJ Tool

- 1) Prepare ADJ tool, USB DLL and ADJ setting file in the same folder.
- 2) Turn the camera power on which is set in the USB test mode and let it enter the USB test mode directly (the test menu appears right after the power is turned on).
- 3) Boot "adj03SSAW.exe" and use it as follows;
 - To read ADJ data from the camera
 - Press "READ (\$9)".
There is no neto set the model by "FW Item Set".
 - To write ADJ data into the camera
 - Press "WRITE (\$8)".
 - To save ADJ data which is read
 - Select "File" and "Save All ADJ", and save it under an appropriate name.
 - Open ADJ data which is saved
 - 1. Select the model by "FW Item Set", and then press "Load FW ->" button.
2. Select "File" and "Open", and open the necessary file.
 - "Language" radio button can switch the language between Japanese and English in which the name of the ADJ ITEM is displayed.
 - "Radix" radio button can switch the data display between decimal and hexadecimal notations.

2. How to use ADJ Tool when replacing Lens unit

Make sure to perform the following procedure after replacing the lens.

A floppy disk with the lens data is bundled in the spare parts of the lens unit.

- ① Enter the TEST mode.
 1. Turn the power on while pressing both "BS" and "UP" buttons.
 2. Press "DOWN" button, "DOWN" button, "BS" button, and "MENU" button while the program version is displayed.
 3. Select "2.USB TCC TEST", and press "SET" button.
 4. Select "1. USB TCC ON", and press "RIGHT" button, "RIGHT" button and "SET" button.
 5. Turn the power OFF.
- ② Connect the camera to the computer by the USB cable.
- ③ Boot "adj03ssaw" .
- ④ Select the model name and click "Load FW → " Key.
 - EX-S770
- ⑤ Click "ADJ ALL READ", and display the data on the "adj03ssaw".
- ⑥ Find the No.1163, "LCD VCOM DC".
- ⑦ Write down this value(data).
- ⑧ Replace the Lens unit.
- ⑨ Perform the above ① to ③.

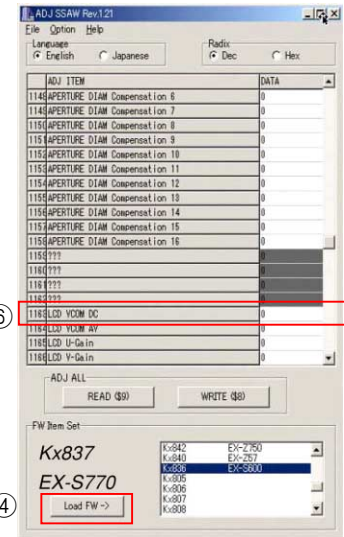

- ⑩ Select the model name and click "Load FW → " Key.
 - EX-S770
- ⑪ From "File/Open", open the bundled floppy disk, and transfer the data to the "adj03ssaw".
- ⑫ Find the No.1163, "LCD VCOM DC"
- ⑬ Change the data to the former value.(Refer to ⑦).
- ⑭ Click "WRITE" button of "ADJ ALL".
- ⑮ After adjustment, change "1. USB TCC ON" to "2. USB TCC OFF".

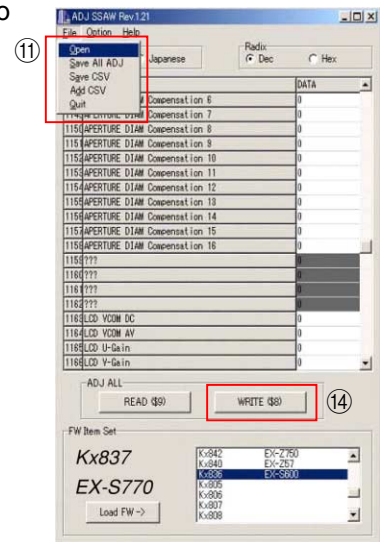

3. How to use ADJ Tool when replacing MAIN PCB

Firmware is not installed in spare parts.

- ① Enter the TEST mode.
 1. Turn the power on while pressing both "BS" and "UP" buttons.
 2. Press "DOWN" button, "DOWN" button, "BS" button and "MENU" button while the program version is displayed.
 3. Select "2.USB TCC TEST", and press "SET" button.
 4. Select "1. USB TCC ON", and press "RIGHT" button, "RIGHT" button and "SET" button.
 5. Turn the power OFF.
- ② Connect the camera to the PC by the USB cable.
- ③ Boot "adj03ssaw".
- ④ Select the model name and click "Load FW → " Key.
 - EX-S770
- ⑤ Click "ADJ ALL READ", and display the data on the "adj03ssaw".
- ⑥ Save the data.
- ⑦ Replace the MAIN PCB.
- ⑧ Writing the Firmware.

Write the firmware into a spare part after replacing one.

NOTE: If a battery is inserted without the firmware, only LED blinks green and the camera does not operate.

- ⑨ Perform the above ① to ③.
- ⑩ Select the model name and click "Load FW → " Key.
 - EX-S770
- ⑪ Open the file which is saved above, and display the data on the "adj03ssaw".
- ⑫ Click "WRITE" button of "ADJ ALL".
- ⑬ After adjustment, change "1. USB TCC ON" to "2. USB TCC OFF".

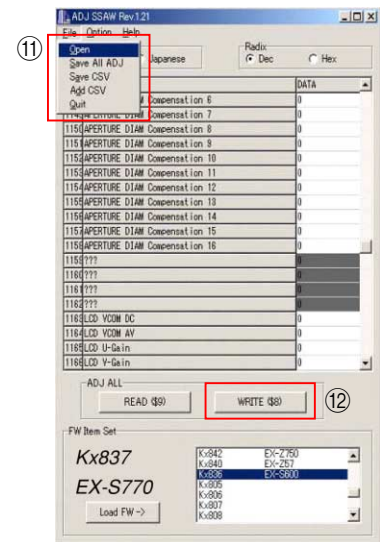
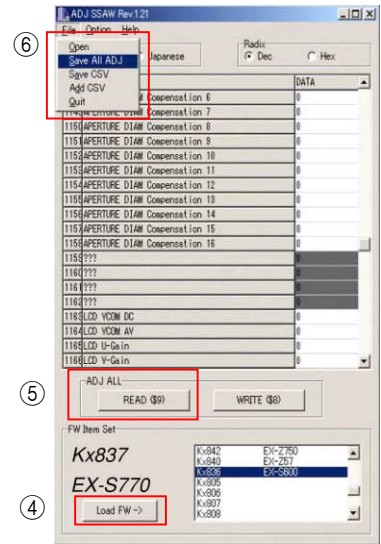

VCOM DC ADJUSTMENT

■ Purpose

Readjust the VCOM value to minimize the flicker of the LCD after replacing the LCD or the main PCB.

■ Necessary tools

1. Camera (Charge its battery fully)
2. Photo diode (S2281-01) : See Fig 1.
3. Photo sensor amp (C2719) : See Fig 2.
4. BNC-BNC cable (E2573) x 2 : See Fig 3.
5. 9-volt alkaline battery (6LR61Y) x 2 : See Fig 4.
6. Oscilloscope

■ Preparation

1. The three tools can be obtained from the following global site.

Photo diode (S2281-01)

Photo sensor amp (C2719)

BNC-BNC cable (E2573)

www.hamamatsu.com/

2. 9-volt alkaline battery is a standard one, but can be obtained from the following global site as well.

www.panasonic.co.jp/global/

Fig1 Photo Diode (S2281-01)



Fig2 Photo Sensor Amp (C2719)



Fig3 BNC-BNC Cable (E2573)



Fig4 6LR61Y



■ Procedure

1. Camera setting

- a) Turn the power on while pressing “BS” and “UPPER”.
After pressing “DOWN” key twice, press “BS” and “MENU”.
Select "2:USB TCC TEST", and press "SET" button.
Select "1:USB TCC ON", and press "RIGHT" button , "RIGHT" button and "SET" button.
Figure (a) appears.

Figure (a)

```
* 1: VERSION INFO
2: USB TCC TEST
3: ROM UPDATE
4: LAST MEMORY
5: FORMAT
6: HARD TEST
7: IMAGE TEST
8: ADJ TEST
9: TEST SCRIPT
```

- b) Select “8 : ADJ_TEST” and then press SET.
(See Figure (b).)

Figure (b)

```
* 1: ADJ STAT CLR
2: LCD
3: LENS
.
.
.
```

- c) Next, select “2. LCD” and then press SET.
(See Figure (c).)

Figure (c)

```
* 1: VCOM OK
.
.
.
```

- d) Pressing SET causes the right figure to appear.
(See Figure (d).)

Figure (d)

```
OK -> RegisterWrite
VCOM = 0xca
```

This value is an example and differs by products

2. Connecting the TOOL

- a) Place two 9-volt alkaline batteries in C2719.
- b) Connect the output terminal of C2719 to the channel terminal of the oscilloscope by the BNC-BNC cable.
- c) Connect the input terminal to the Photo Diode by the BNC cable.
- d) Turn the oscilloscope and C2719 on.
* Pull the ON/OFF switch of C2719 this way and raise/lower it. (See below Figure.)



3. Measurement

- a) Connect S2281-01 to the camera's LCD monitor (see below).
 AC Waveforms appear on the monitor screen of the oscilloscope.
 * Change the Rf range of C2719 in case the range does not match.

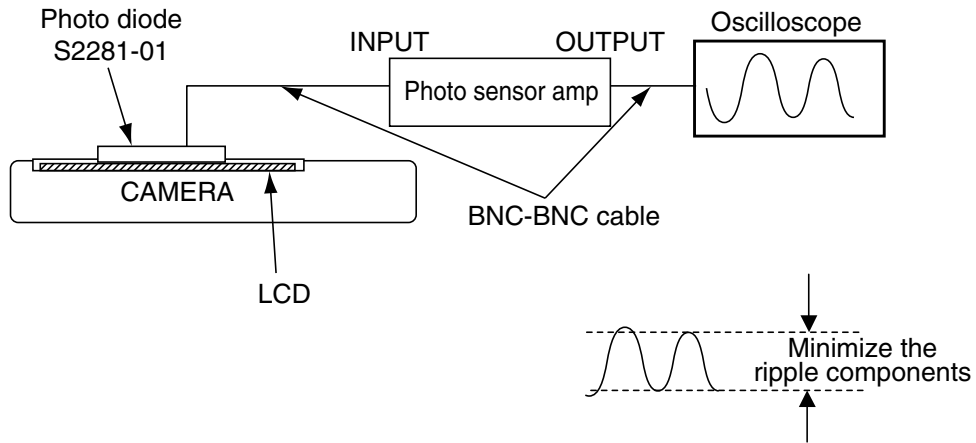

- b) After AC waveforms of the oscilloscope appear, minimize it by pressing the camera's up/down buttons (see the picture).
 Make sure to visually check if it has been minimized.

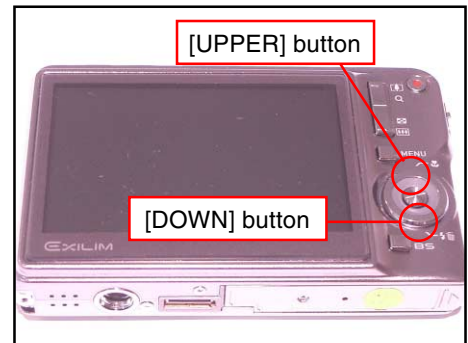

After it has been minimized, press SET key.
 The screen in the right figure appears and the new VCOM is written (VCOM adjustment is finished.).

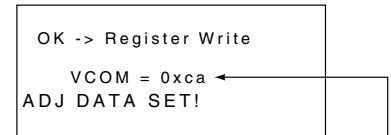

This value is only an example, and differs by products.



Return to the previous display by pressing MENU or PW key.

CURRENT CONSUMPTION

(1) Current consumption (DC in = 3.80 ± 0.1 [V])

- Make sure that current consumption is less than 215 mA in PLAY mode.
(TCC ON, USB connection : less than 250 mA)
- Make sure that current consumption is less than 440 mA in REC mode.
(TCC ON, USB connection : less than 475 mA)
- Make sure that current consumption is less than 500 μ A when power is turned OFF.
(TCC ON, USB connection : less than 630 μ A)

(2) The battery indicator changes according to the voltages as follows.

- DC in = less than 3.71 ± 0.02 V:  (PLAY mode)
- DC in = less than 3.62 ± 0.02 V:  (PLAY mode)
- DC in = less than 3.53 ± 0.02 V:  (PLAY mode)

THE COUNTERMEASURE FOR "SYSTEM ERROR"

System error may occur when the battery is removed while data is written to the internal memory.

■ PROCEDURE

1. Initialize the system.

- a) Enter the TEST mode.
- b) Select "3:ROM UPDATE" and press SET button.
- c) Next, select "5:SYSTEM INITIAL" and press SET button.
- d) The following message appears.
SYSTEM INITIALIZE
START ...
PUSH OK KEY?
- e) Press SET button and System is initialized.
"SUCCESS !" appears on the monitor.

2. Write firmware.

Refer to the "1. To update the firmware version" on page 7.

Write the firmware.

If the TEST mode boots automatically, change "USB TCC ON" to "USB TCC OFF".

Replace the Main PCB if the camera does not recover.

RESETTING THE PLACE OF DESTINATION

When the main PCB is replaced, the setting of the destination will be changed, therefore resetting is required. However, when the firmware is changed or fixed, the setting of the destination will be held, therefore resetting is not required.

Use the destination setting script to change the destination flag as instructed below.

1. Have an SD card ready that have a corresponding script (autorun.scp) under the root directory.
2. Insert the SD card in the camera and turn on the power.
The script is located at Qv/soft/Adj_soft/exs770/Script in the service CD-ROM.
3. After a few seconds, one of the following messages will be shown in the screen.
The system will change the destination flag and turn off the camera automatically.

For North America

For North America
815

Complete

- Number of menu languages: 10 languages
- eBay scene compatible

For Europe and UK

For Europe_UK

Complete

- Number of menu languages: 10 languages
- Movie filming time limited

For others

else

Complete

- Number of menu languages: 10 languages

4. Remove the SD card from the camera and turn on the power to confirm if the camera is set as you wish including the number of the menu languages and the scene of the best shot mode.
If there is no problem, the setting is completed.

DISASSEMBLY

* Make sure to use correct screws when assembling since there are several kinds of them.
It is a good idea to sort them as shown in the right when disassembling.

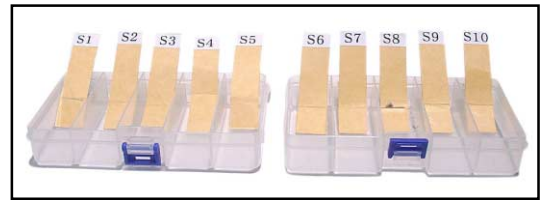

1. Remove the battery.
2. Remove two screws and then remove C-CASE-BA.

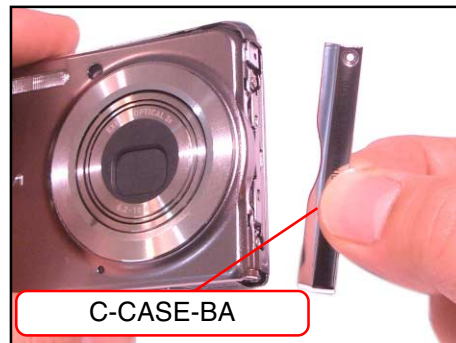
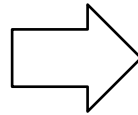
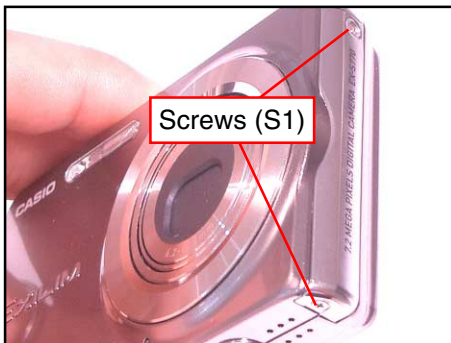

3. Remove two screws and then remove C-CASE-CA.

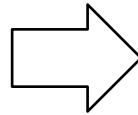
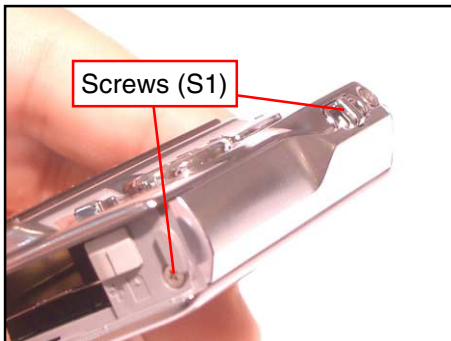

4. Remove one screw and then remove C-CASE-ASSY.

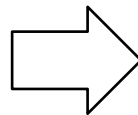

5. Remove six screws.

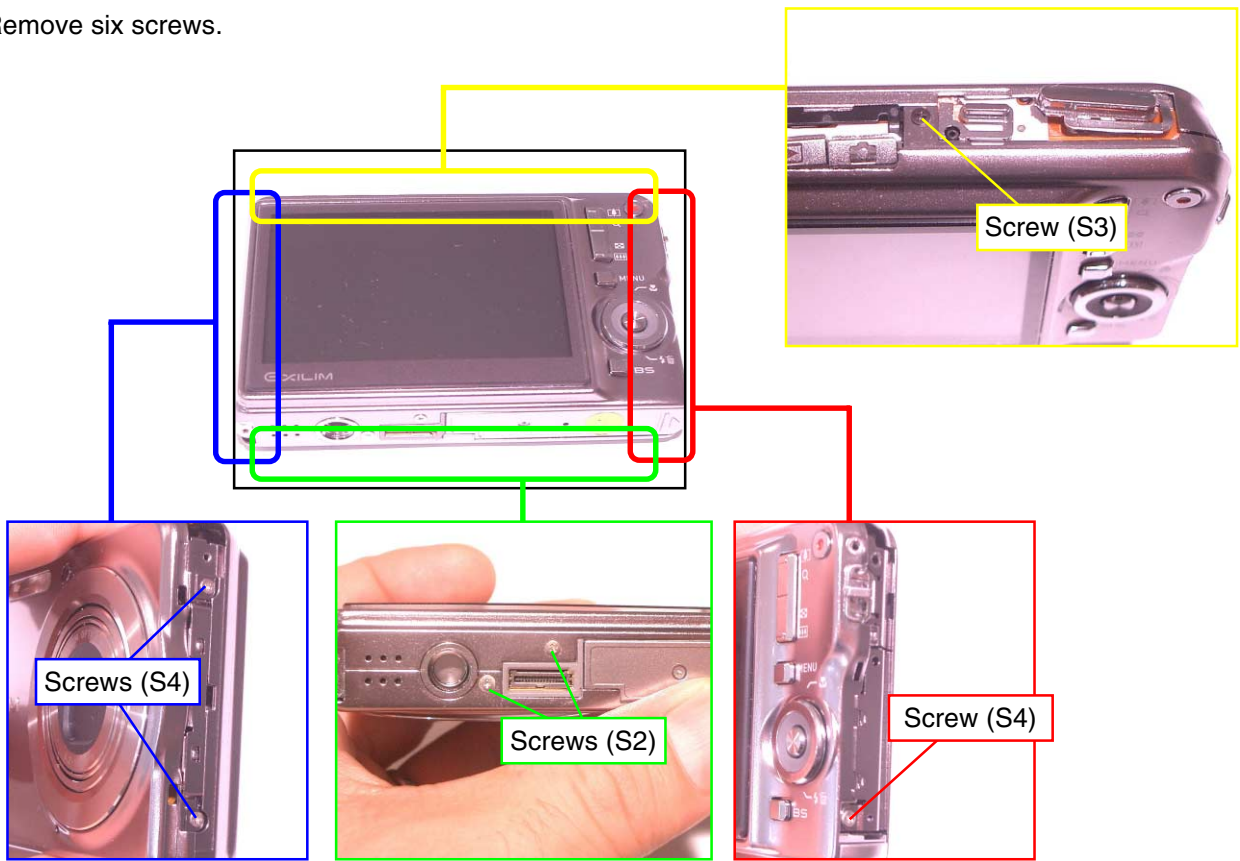

6. Remove the rear panel.

Attention: The power button and the shutter button come off together. Be sure not to lose them.

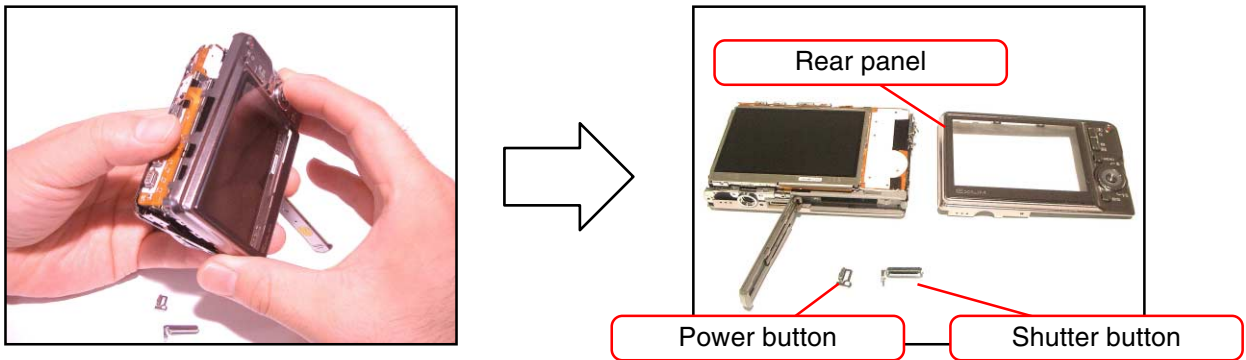

7. Remove the front panel.

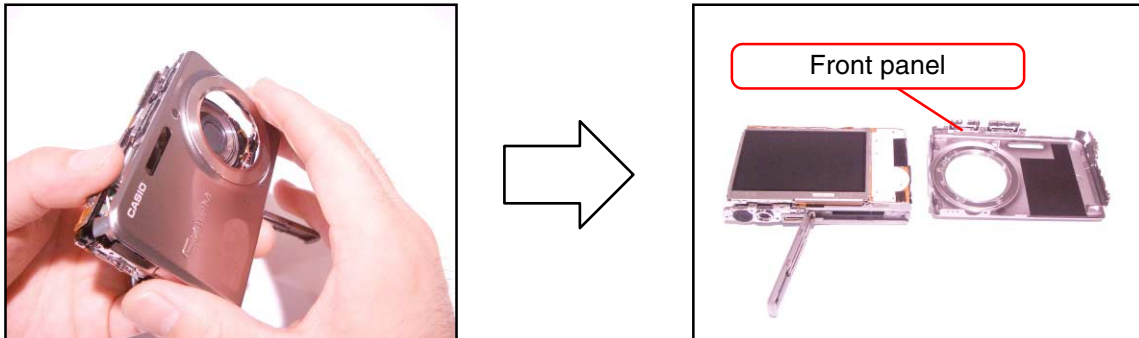

* Cam ring is fixed with three special screws (⊕).

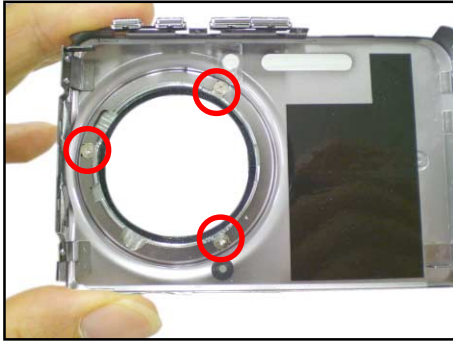

8. Remove the strap board.

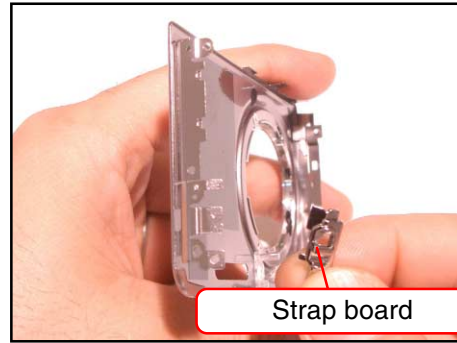
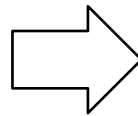
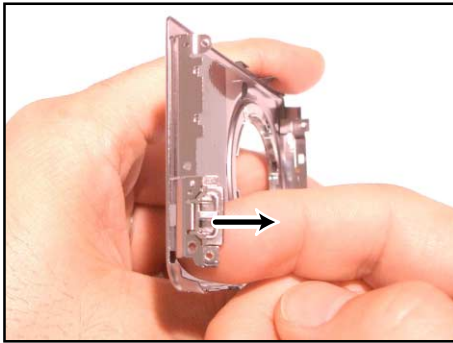

9. Remove the REC SUB ASSY and the DATA SUB ASSY.

* Fixed with double-sided tape.

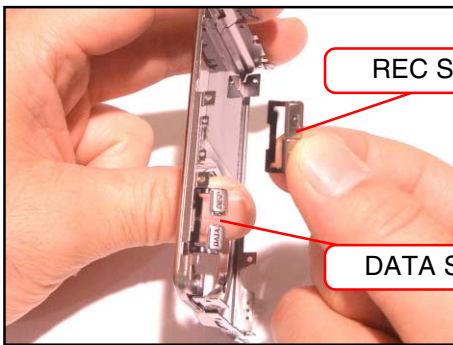

REC SUB ASSY

DATA SUB ASSY



10. Release the lock and remove two FPCs.

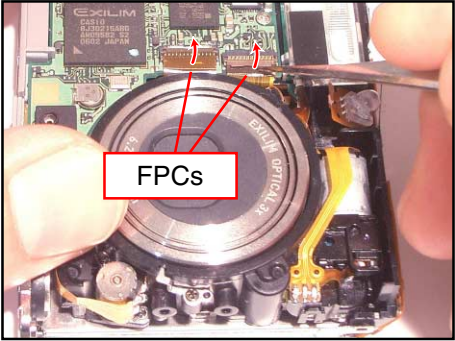

11. Remove two hooks and then remove the lens unit.

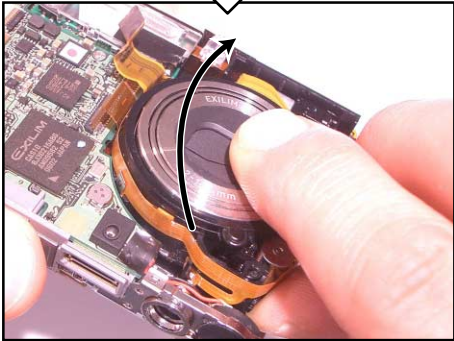
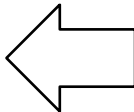
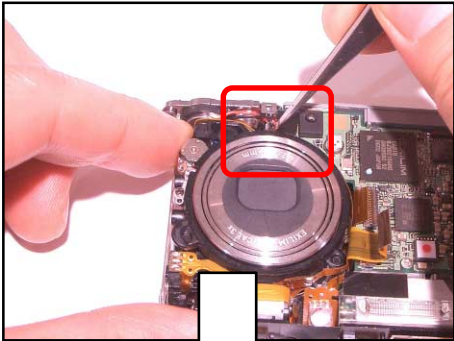
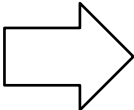
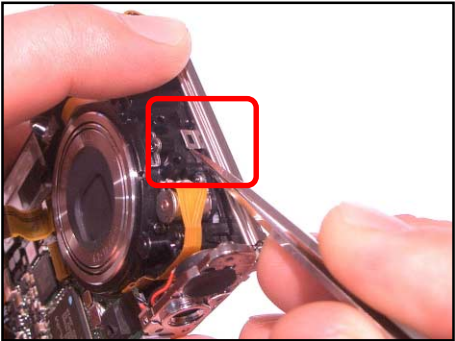

* Hooks are located at three locations as below.

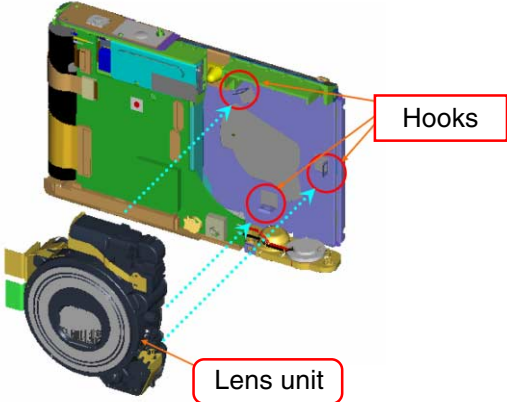

12. Remove the tape fixing the FPC(LCD).

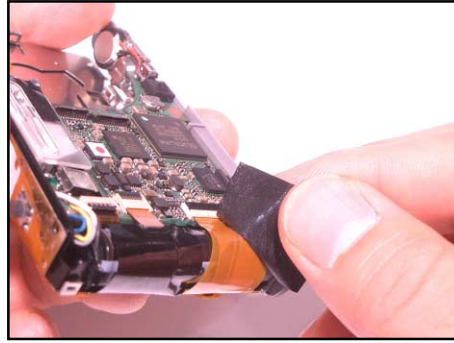
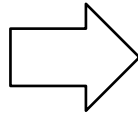
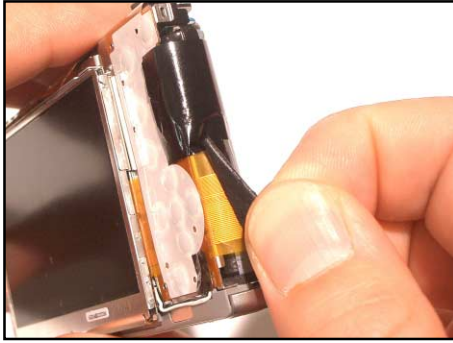

13. Release the lock and remove one FPC.

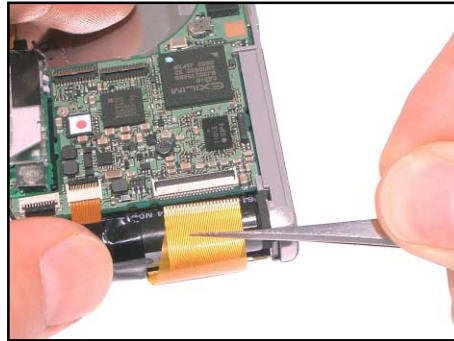
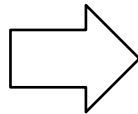
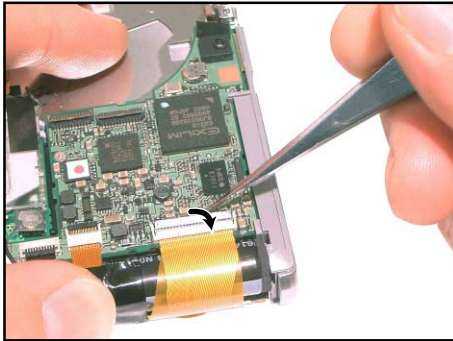

14. Remove the tape.



15. Unsolder to remove two lead wires.

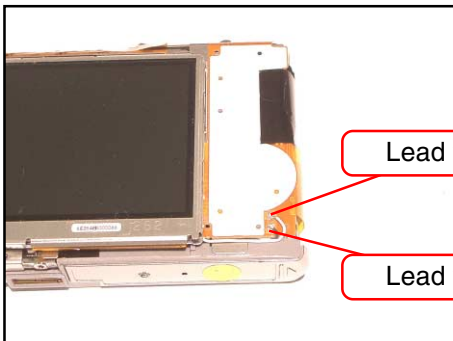

Lead wire (white)

Lead wire (black)

16. Remove the LCD unit.

* Fixed at three locations with double-sided tape.

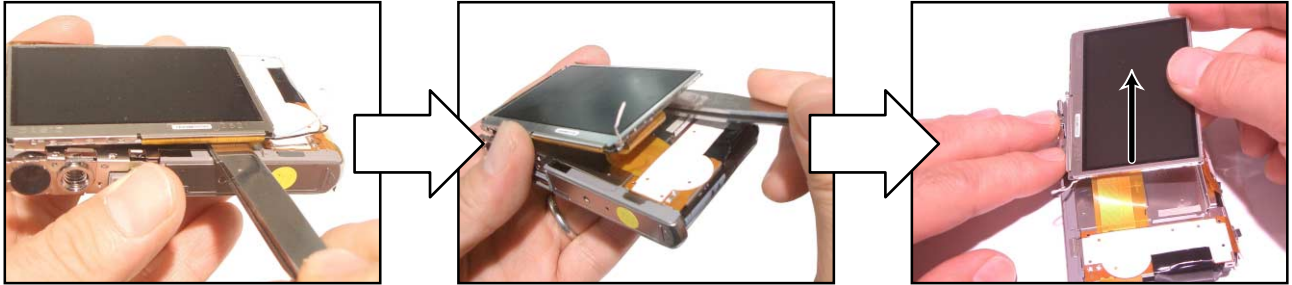
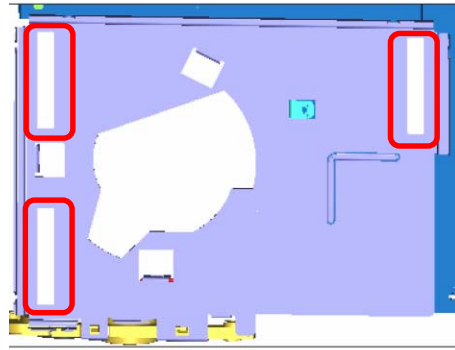

17. Remove one screw and then remove the battery case.

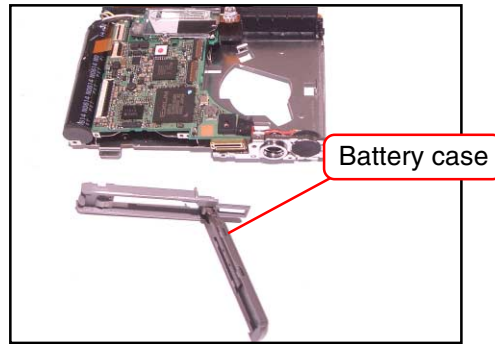
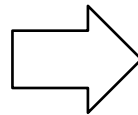
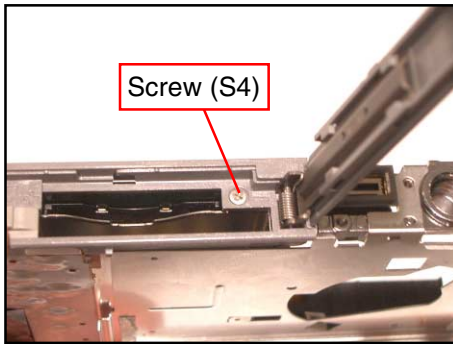

18. Remove the tape.

19. Unsolder to remove two lead wires.

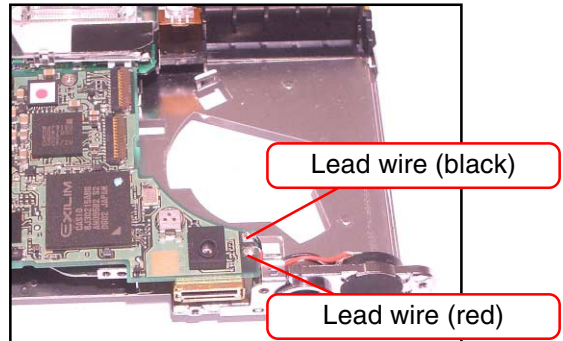
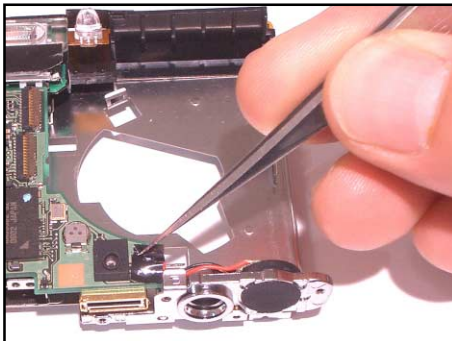

20. Remove the tape.

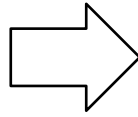
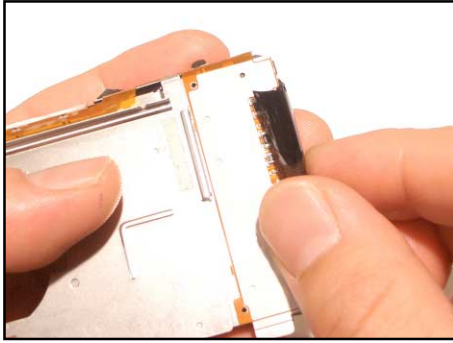

21. Release the lock and remove two FPCs.

22. Remove one screw.

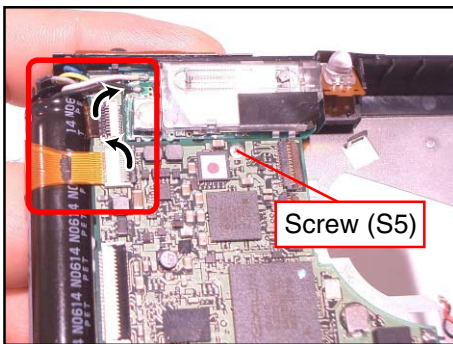

23. Unsolder to remove three lead wires.

24. Remove the main PCB.

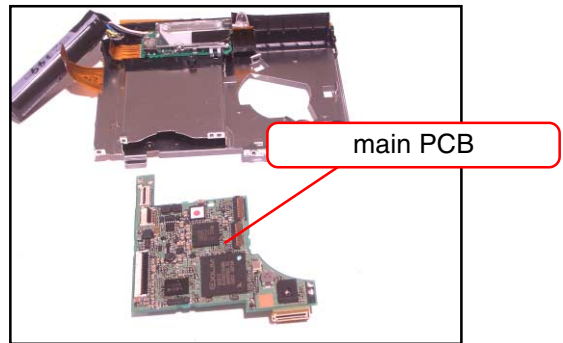
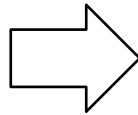
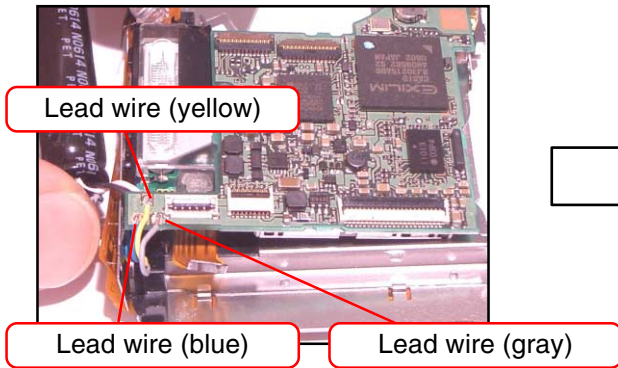

25. Remove the protection tape and then discharge the strobe condenser.

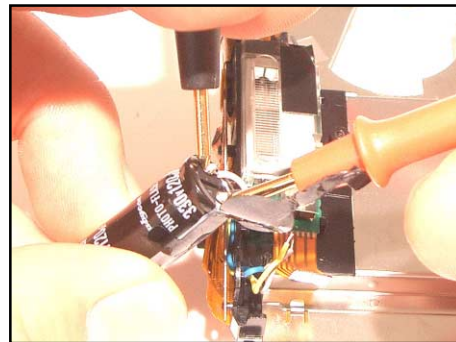
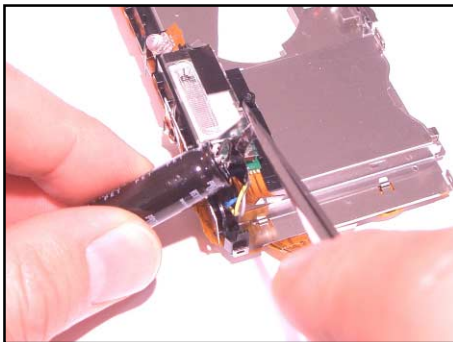

26. Remove the key FPC.

* Fixed with double-sided tape.

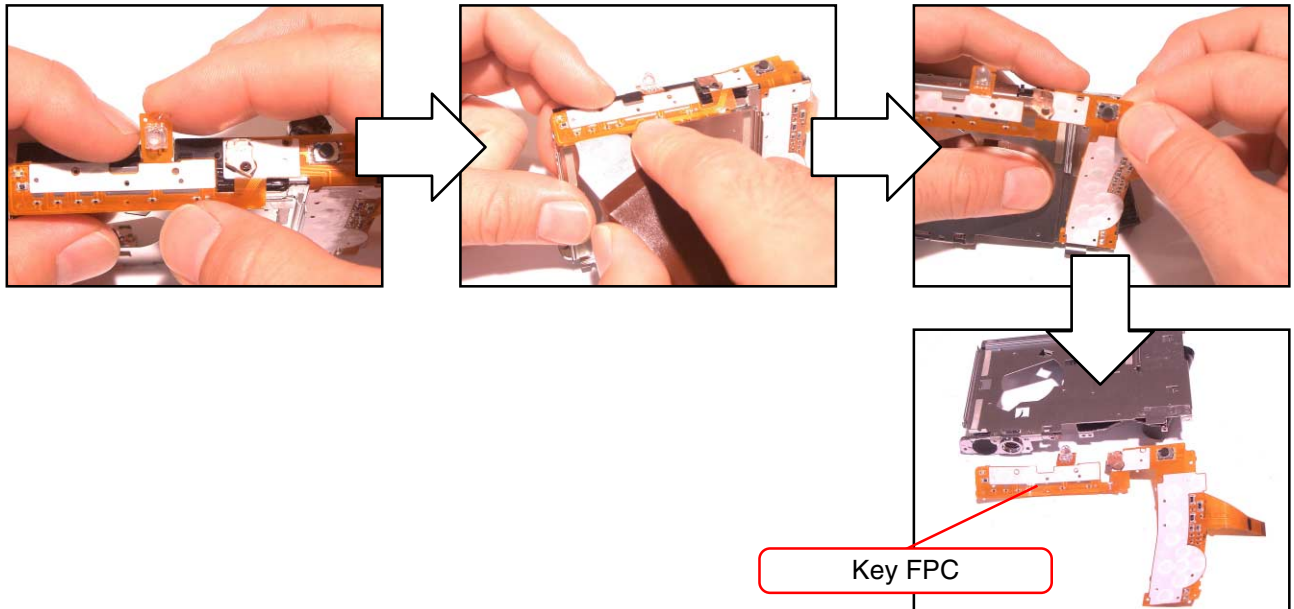

27. Remove the shutter plate.

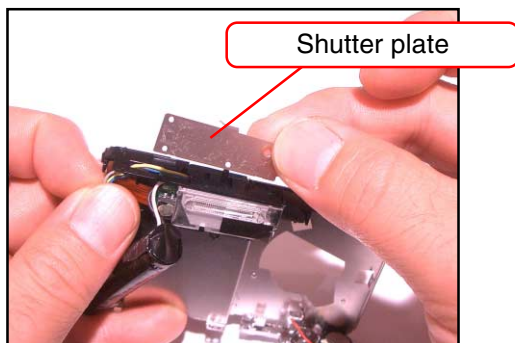

28. Remove the TRIPOD ASSY.

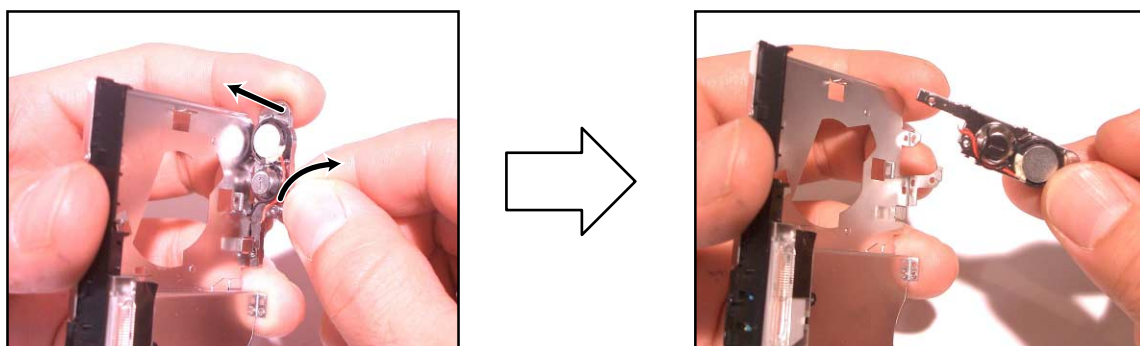

29. Remove the strobe assy.
* Fixed with four hooks.

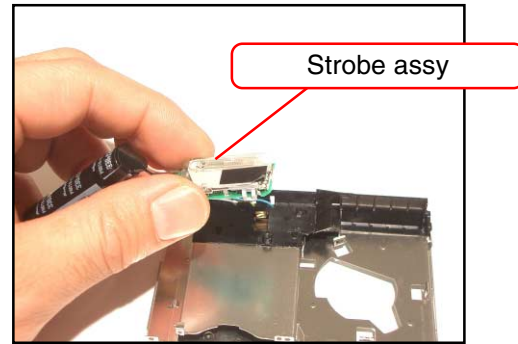
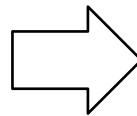
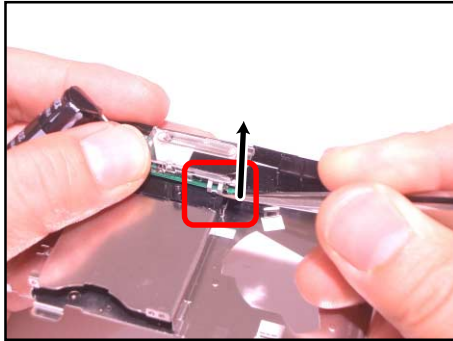
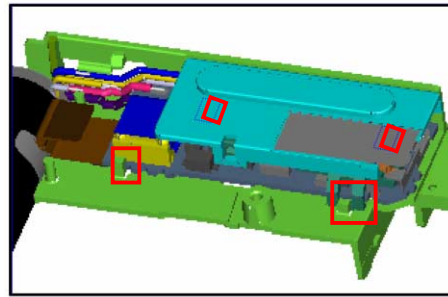

30. Remove the strobe assy.
* Fixed with three hooks.

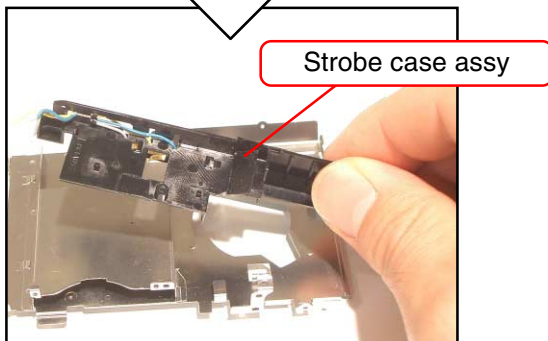
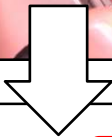
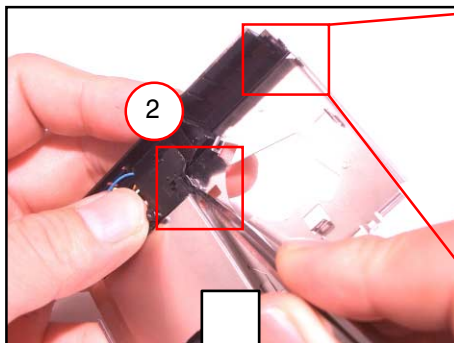
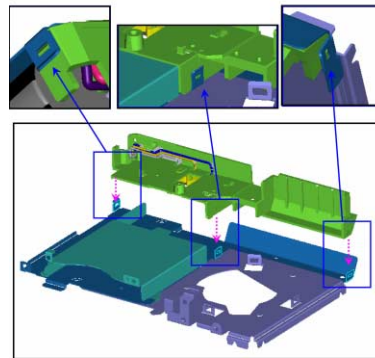

ASSEMBLY

1. Set the strobe case assy.

* Fix it with three hooks.

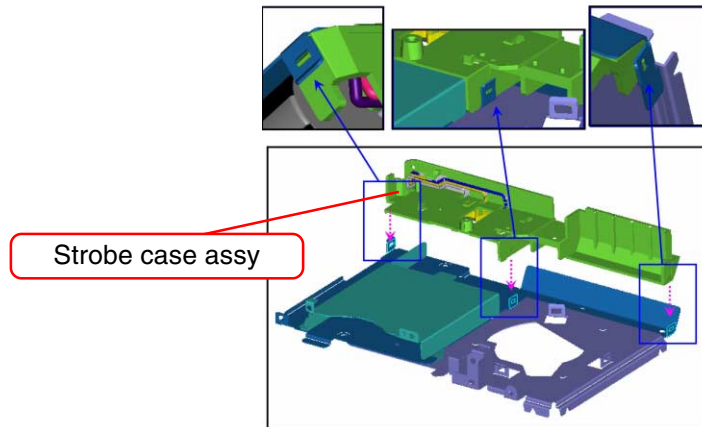

2. Set the strobe assy.

* Fix it with three hooks.

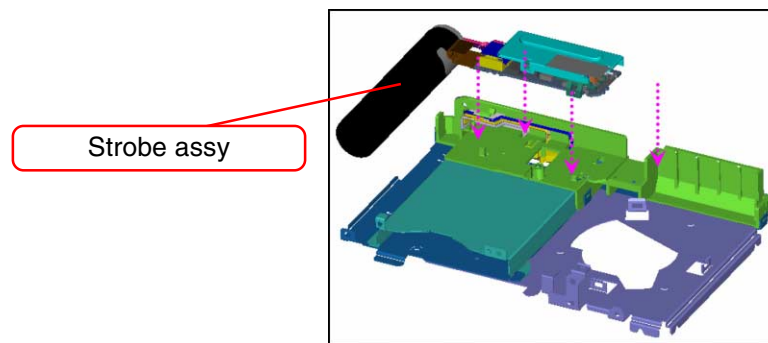

3. Remove the TRIPOD assy.

* Fix it with three hooks.

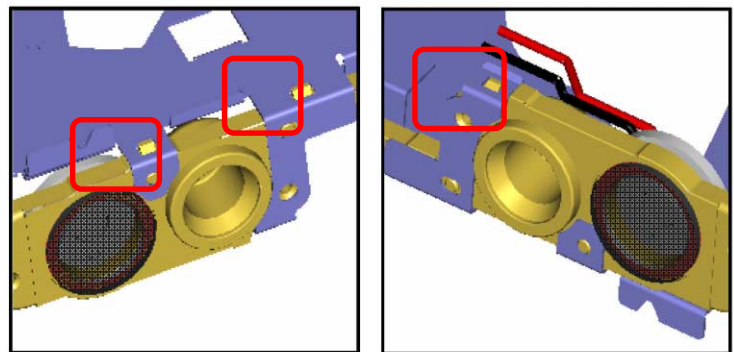

4. Set the shutter plate.

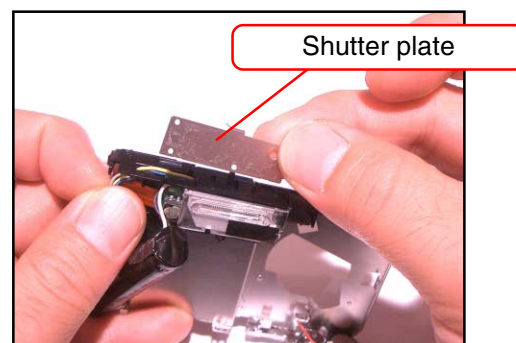

5. Set the LCD.

* Fix it with a double-sided tape at three locations.

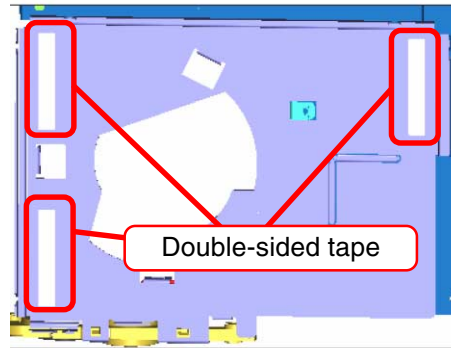
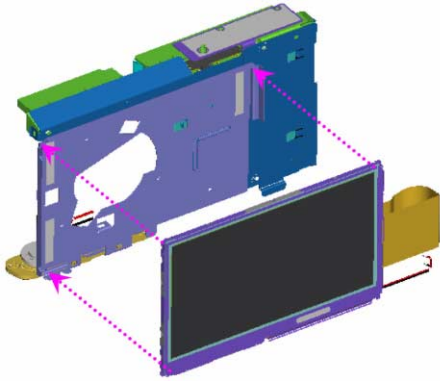

* If the key FPC is not removed, place the LCD FPC under the key FPC.

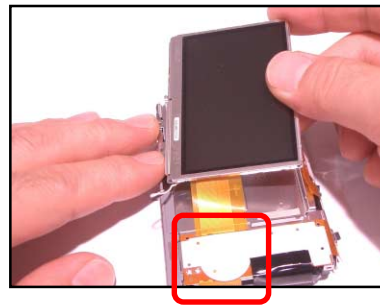

6. Set the key FPC.

There are eight pins as your positioning guide.

Follow the assembling order as below.

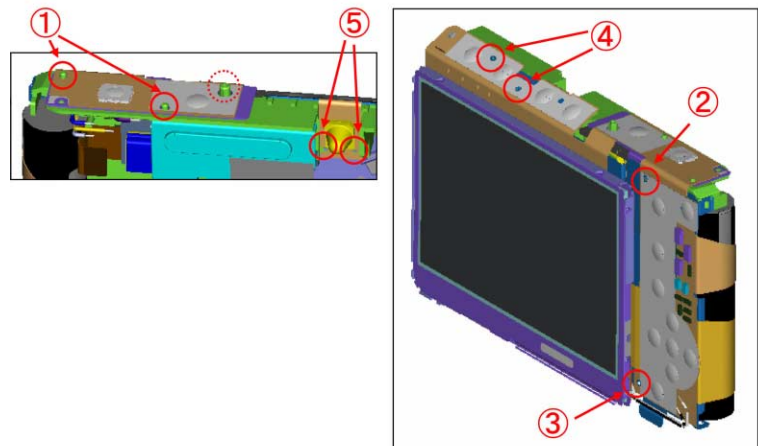

- 7. Solder two LCD lead wires.
- 8. Tape on the lead wires.

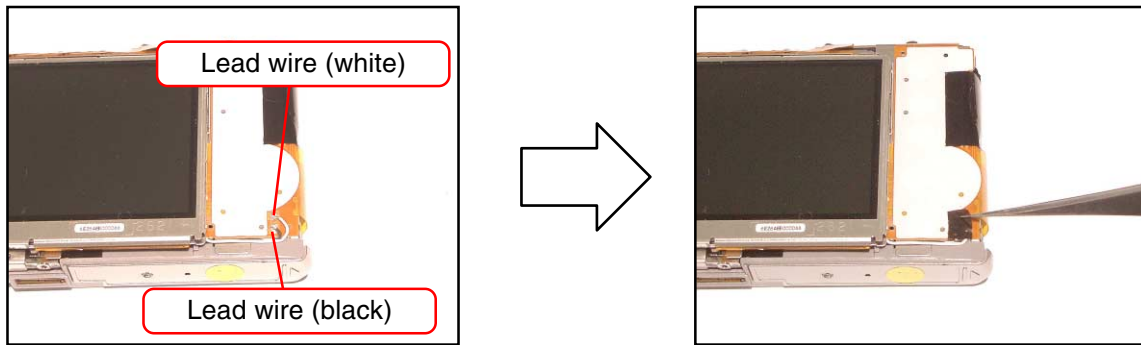

- 9. Set the battery case with one screw.

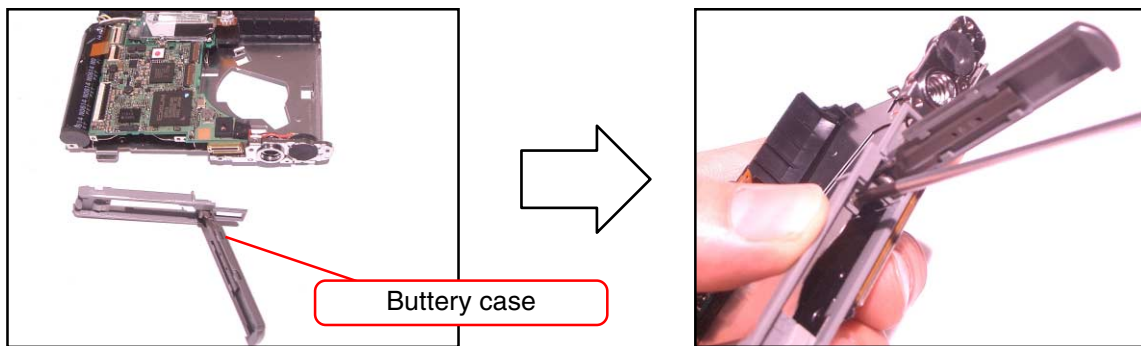

- 10. Set the LCD with one screw.

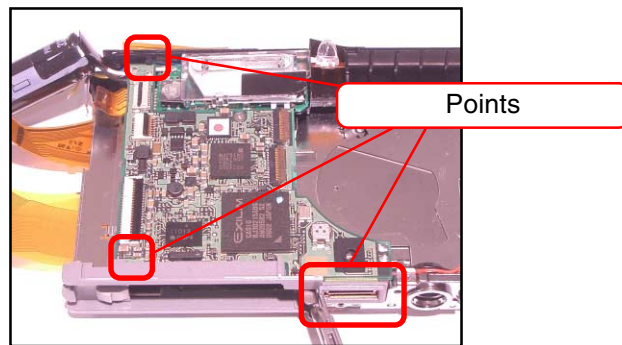

- 11. Solder two speaker lead wires.
- 12. Tape on the lead wires.

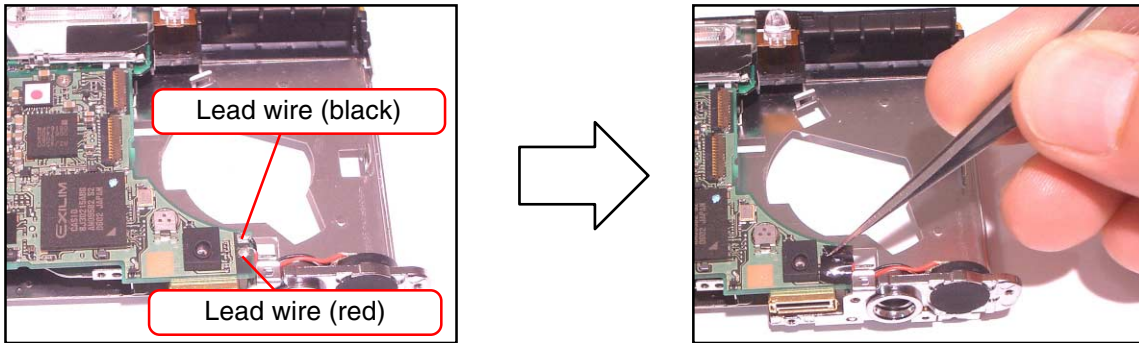

- 13. Solder three power lead wires.

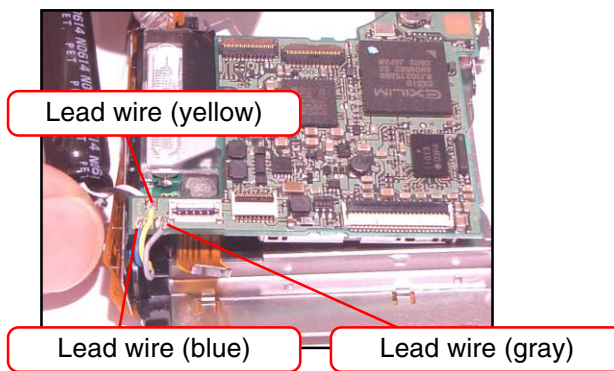

- 14. Connect three FPCs.
- 15. Tape on FPC at two locations.

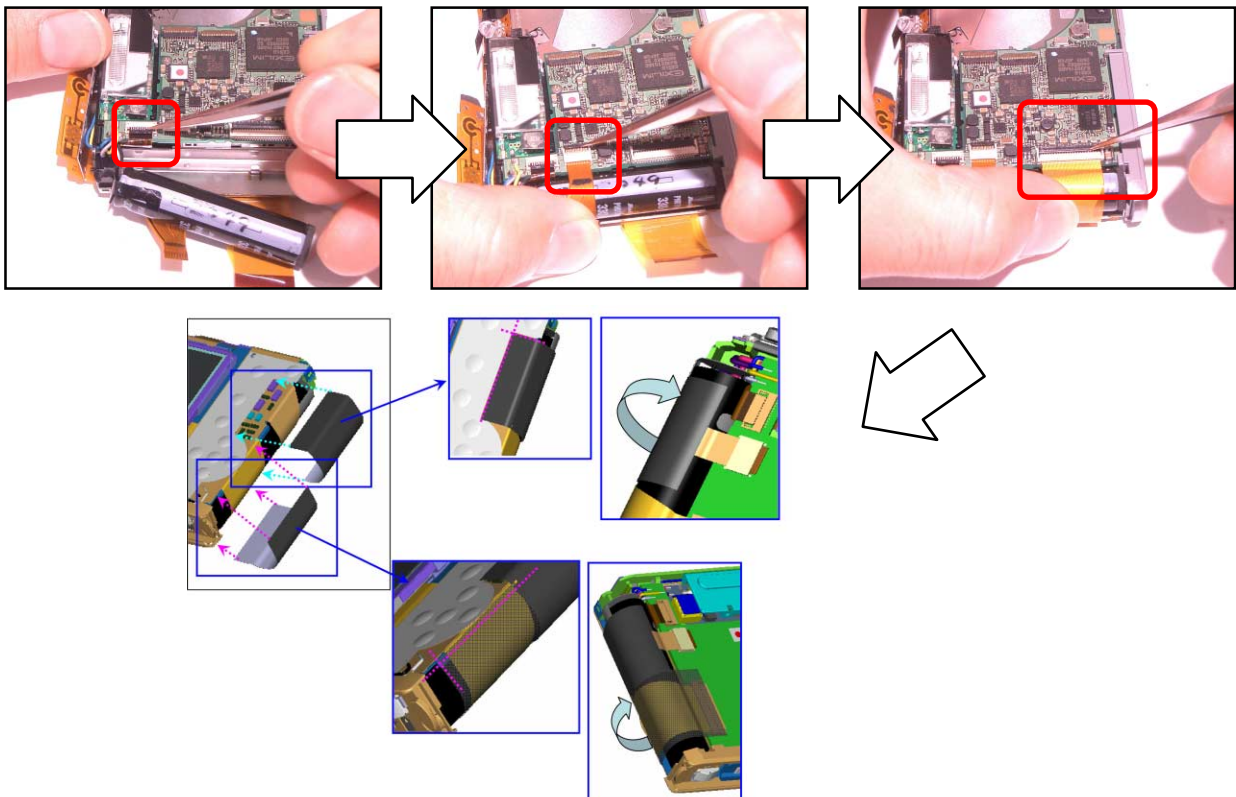

16. Set the lens unit.
* Fix it with three hooks.

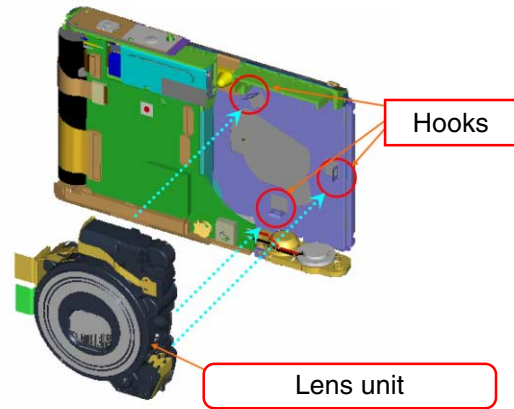

17. Connect two FPCs of the lens unit.

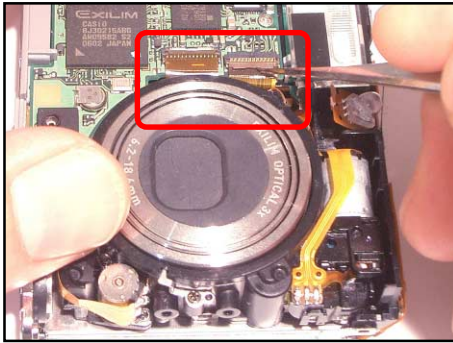

18. Set the REC sub assy and the DATA sub assy.

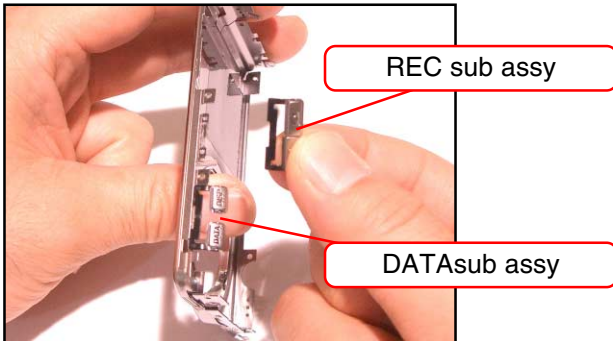

19. Stick the conductive (black) ring onto the front panel.
There is no conductive ring on the front panel assembly in maintenance parts.
Use double-sided tape to attach the conductive ring.

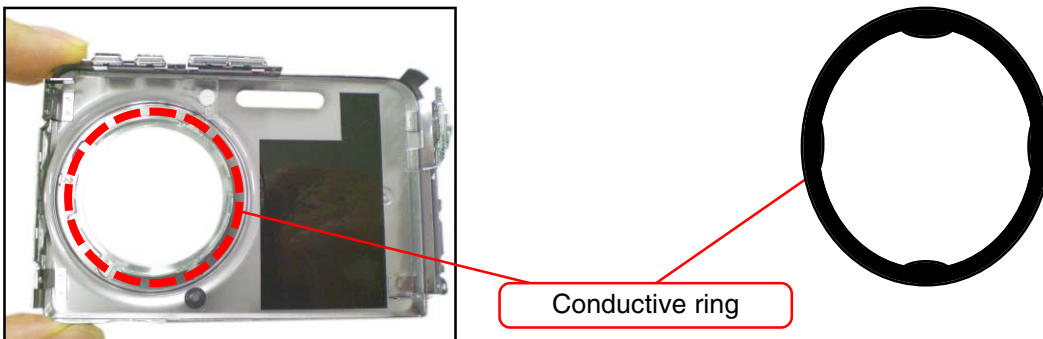

■ Procedure for attaching the conductive ring

Preparation:

- Defective lens with the lens fully extended
(A defective lens from an EX-Z500 or Z600 can also be used.)
- Double-sided tape (4 pieces)



(1) Attach the 4 pieces of double-sided tape and remove the protective stickers.

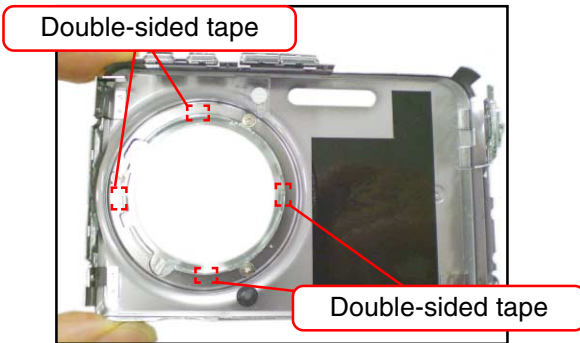

(2) Fit the defective lens into the front panel assembly as shown in the figure.

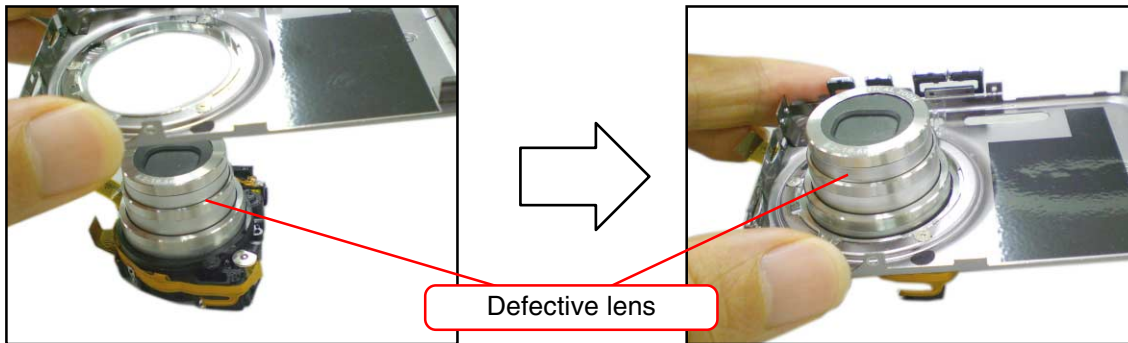

(3) Fit the conductive ring onto the front panel assembly so that it passes over the defective lens.

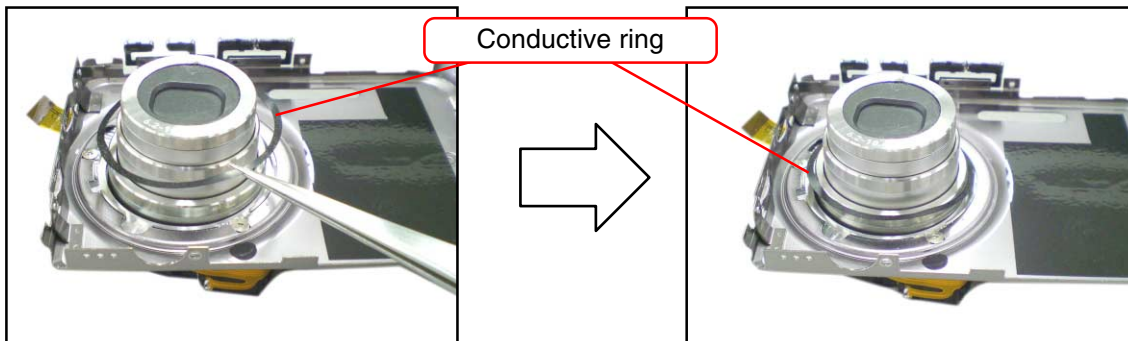

<Caution>

Position the conductive ring so that the 4 slightly thicker sections of the ring make contact with the double-sided tape.

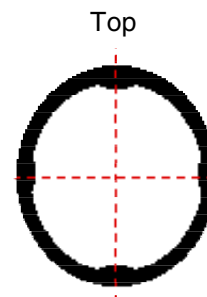

(4) Take the front panel assembly off the defective lens.

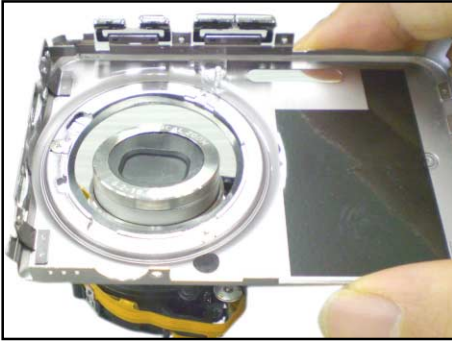

(5) Press on the conductive ring to fix it in place.



20. Set the front panel.

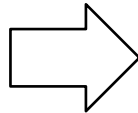

21. Set the strap board.

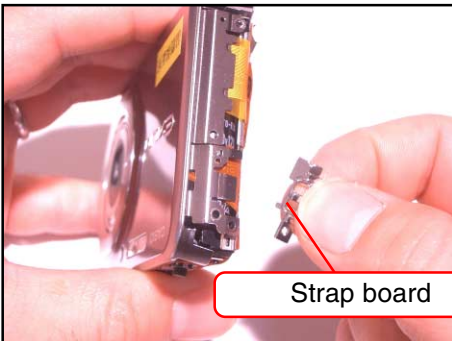

22. Set the power button the shutter button.

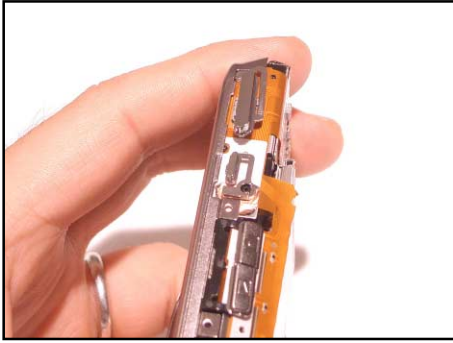

23. Set the rear panel.



24. Assemble with six screws.

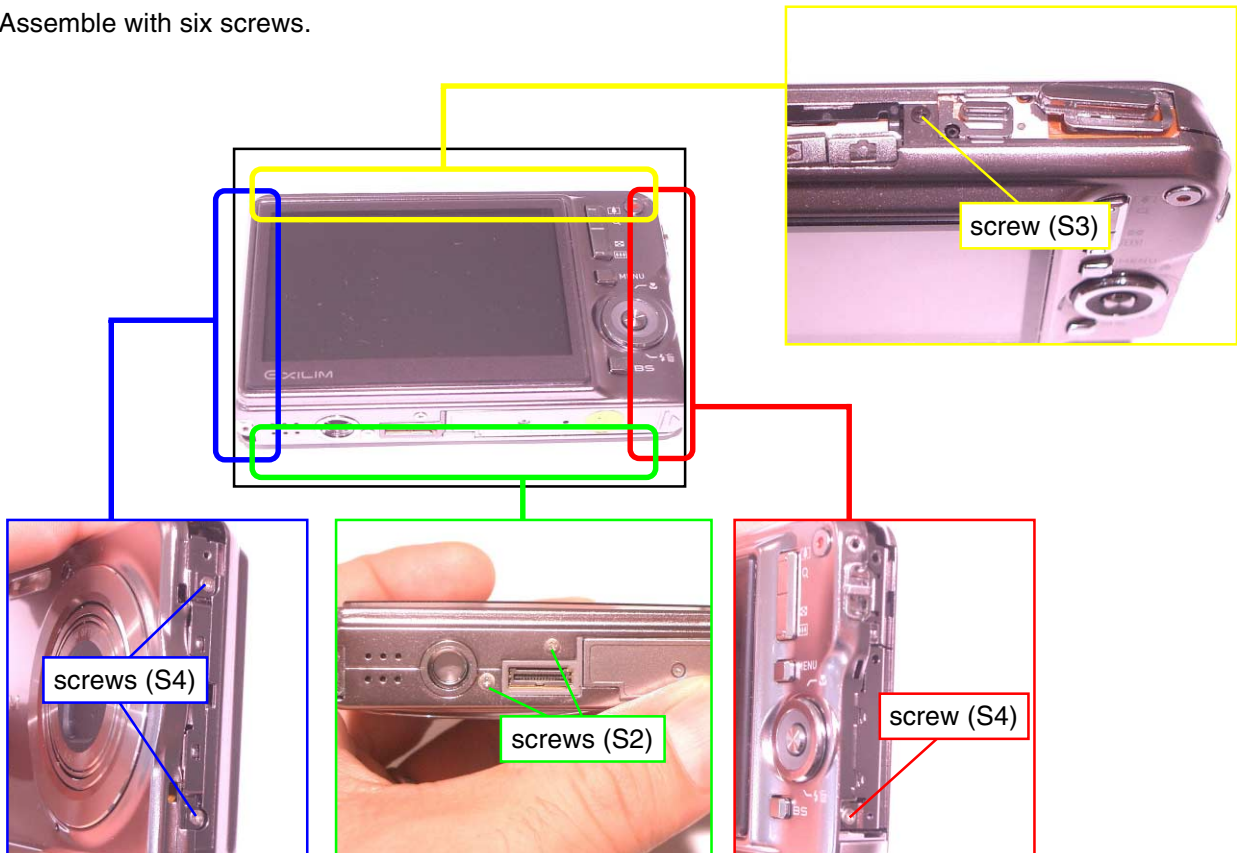

25. Set the C-CASE-ASSY with one screw.

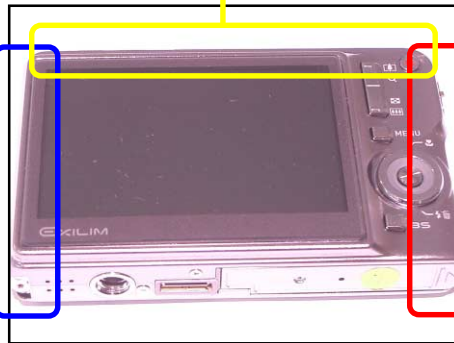
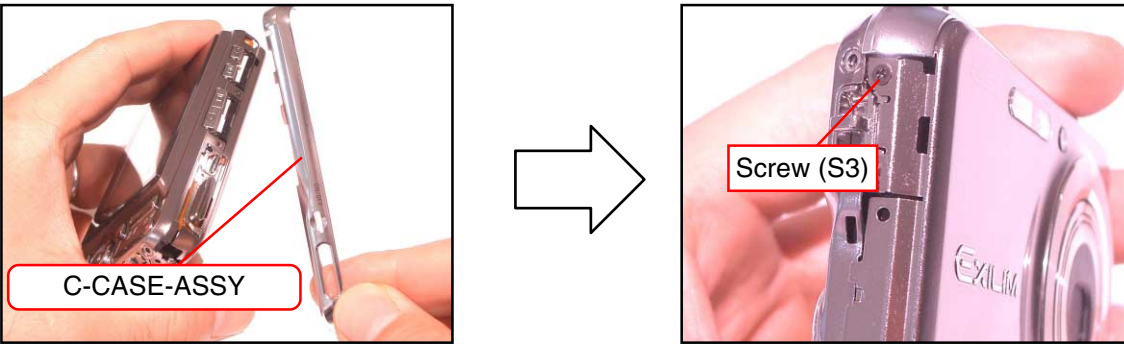

26. Set the C-CASE-BA with two screws.

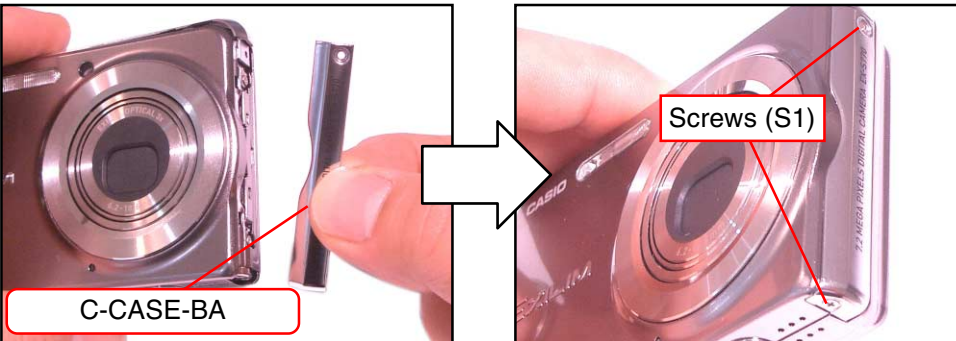

27. Set the C-CASE-CA with two screws.

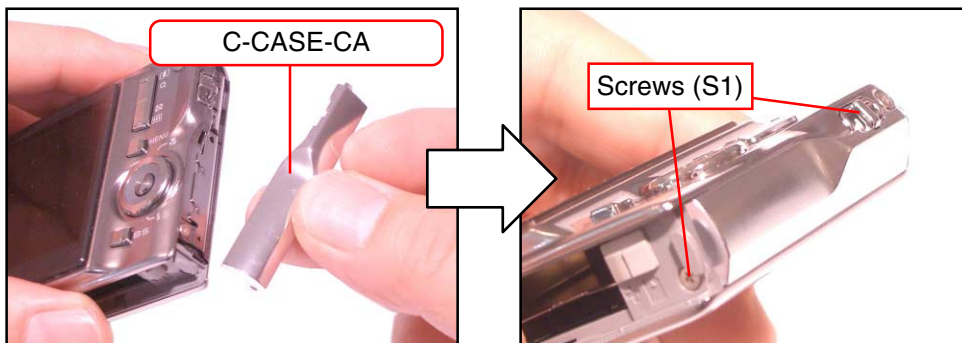

EXPLODED VIEW

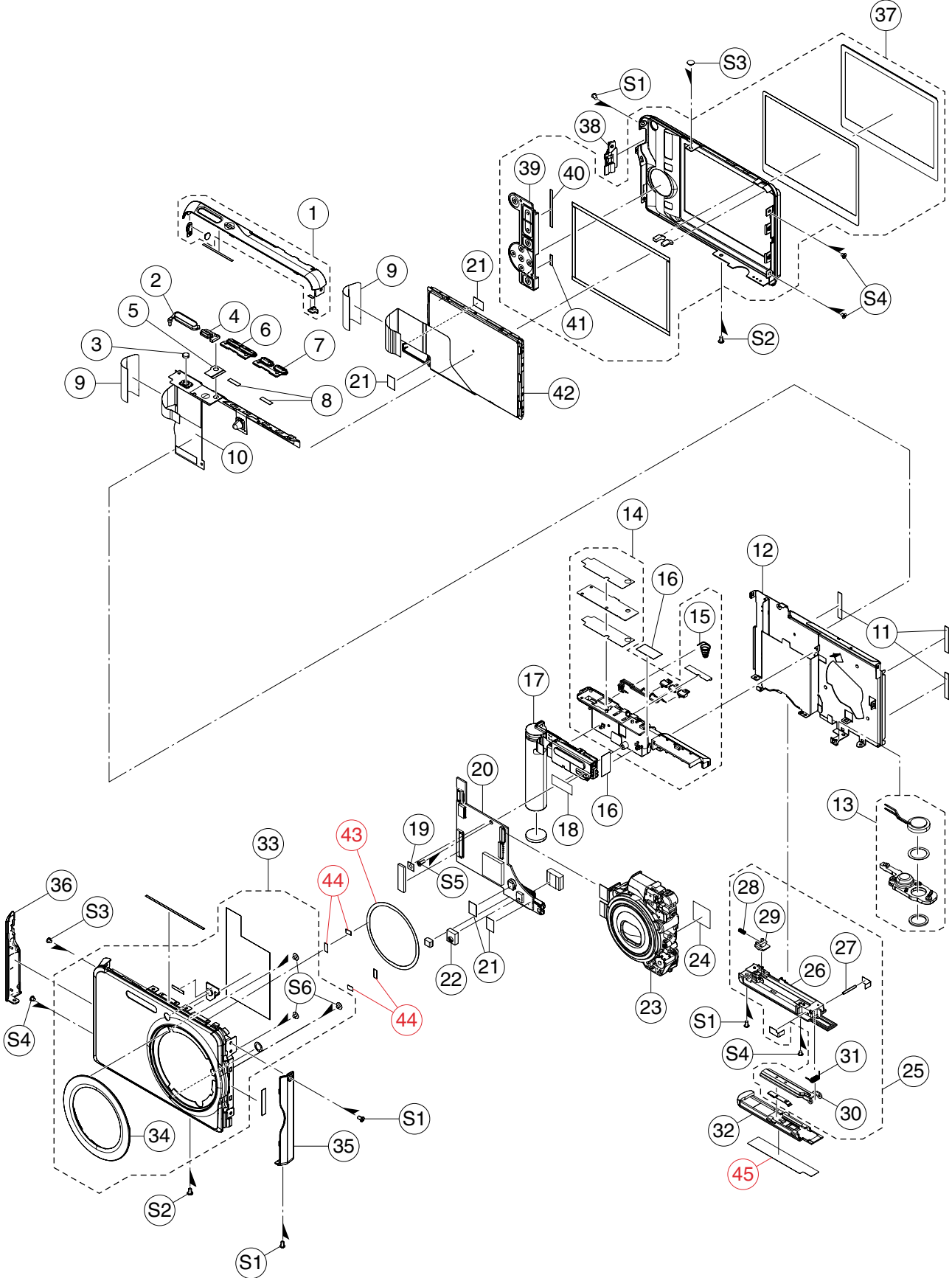

PARTS LIST

N	Item	Parts Code	Parts Name	Specification	QTY			Price Code	R	Remark
					Silver	Red	Blue			
N	1	10252942	CASE ASSY/CENTER	TK-RJK509311*001	1	0	0	BB	C	
N	1	10252943	CASE ASSY/CENTER	TK-RJK509311*002	0	1	0	BB	C	
N	1	10252944	CASE ASSY/CENTER	TK-RJK509311*003	0	0	1	BB	C	
N	2	10251069	SHUT-BUTTON/SHUT/A	RJK509270-001V01	1	0	1	AF	C	
N	2	10251086	SHUT-BUTTON/SHUT/B	RJK509270-002V01	0	1	0	AG	C	
N	3	10236155	CUSHION/SHUT	RJK508936-001V01	1	1	1	AA	C	
N	4	10251070	BUTTON/PW/A	RJK509269-001V01	1	0	1	AE	C	
N	4	10251123	BUTTON/PW/B	RJK509269-002V01	0	1	0	AF	C	
N	5	10251116	TAPE/PW	RJK509323-001V01	1	1	1	AA	X	
N	6	10254837	KEY/REC-PLAY	RJK509431*001V01	1	0	1	AQ	C	
N	6	10254838	KEY/REC-PLAY	RJK509431*002V01	0	1	0	AR	C	
N	7	10254839	KEY/DATA-DISP	RJK509432*001V01	1	0	1	AQ	C	
N	7	10254840	KEY/DATA-DISP	RJK509432*002V01	0	1	0	AR	C	
N	8	10251080	TAPE/BUTTON	RJK509250-001V01	2	2	2	AA	X	
N	9	10251137	TAPE/FPC	RJK509275-001V01	2	2	2	AA	C	
N	10	10251111	FPC/KEY	HKW1658-010010-S	1	1	1	BJ	C	
N	11	10251115	TAPE/LCD	RJK509236-001V01	3	3	3	AA	C	
N	12	10251107	FRAME ASSY	RJK509276*001V01	1	1	1	AR	X	
N	13	10252936	TRIPOD ASSY	TK-RJK509310*001	1	1	1	AS	X	
N	14	10252933	CASE ASSY/STROBE	TK-RJK509307*001	1	1	1	AO	C	
	15	10200800	SPRING/BATTERY	RJK507791-001V01	1	1	1	AA	C	
	16	10241457	TAPE/FPC	RJK509039-001V01	2	2	2	AA	C	
N	17	10251106	STROBE UNIT	XEST-K837-S	1	1	1	BX	C	
N	18	10170543	TAPE/ST	RJK506569-004V01	1	1	1	AA	C	
	19	10113024	SEAL/DETECTION	RJK504361-001V01	1	1	1	AA	C	
N	20	10252927	PCB ASSYMAIN	TK-RJK509162*001	1	1	1	DR	A	
N	21	10254783	TAPE/CABLE	RJK509415-001V01	4	4	4	AA	C	
N	22	10251135	MIC RUBBER	RJK509201-001V01	1	1	1	AA	X	
	23	10251484	LENS UNIT	RJK509312*001 TK	1	1	1	DV	A	*1
	24	10200801	TAPE/LENS	RJK507795-001V01	1	1	1	AB	C	
N	25	10252934	CASE ASSY/BATTERY	TK-RJK509308*001	1	1	1	AN	C	
N	26	10251119	CASE/BOTTOM	RJK509255-001V01	1	1	1	AD	X	
N	27	10251121	SHAFT/BATTERY	RJK509272-001V01	1	1	1	AA	X	
	28	10200827	SPRING/BATTERY	RJK507792-001V01	1	1	1	AA	X	
N	29	10251141	KNOB/BATTERY	RJK509268-001V01	1	1	1	AB	X	
N	30	10251120	BRACKET/BATTERY	RJK509289*001V01	1	1	1	AE	C	
N	31	10251122	COIL/BATTERY	RJK509288-001V01	1	1	1	AA	X	
N	32	10251071	COVER/BATTERY	RJK509256-001V01	1	0	0	AI	C	
N	32	10251124	COVER/BATTERY	RJK509256-002V01	0	1	0	AI	C	
N	32	10251090	COVER/BATTERY	RJK509256-003V01	0	0	1	AI	C	
N	33	10252937	CASE ASSY/FRONT	TK-RJK509304*001	1	0	0	CE	C	
N	33	10252938	CASE ASSY/FRONT	TK-RJK509304*002	0	1	0	CE	C	
N	33	10252939	CASE ASSY/FRONT	TK-RJK509304*003	0	0	1	CE	C	
N	34	10251093	CAM RING	RJK509184-001V01	1	1	1	AV	C	
N	35	10251078	CASE/CENTER/B	RJK509253-001V01	1	0	0	AQ	C	
N	35	10251084	CASE/CENTER/B	RJK509253-002V01	0	1	0	AQ	C	
N	35	10251088	CASE/CENTER/B	RJK509253-003V01	0	0	1	AQ	C	
N	36	10251079	CASE/CENTER/C	RJK509254-001V01	1	0	0	AO	C	
N	36	10251085	CASE/CENTER/C	RJK509254-002V01	0	1	0	AO	C	
N	36	10251089	CASE/CENTER/C	RJK509254-003V01	0	0	1	AO	C	
N	37	10252940	CASE ASSY/REAR	TK-RJK509305*001	1	0	0	CI	C	
N	37	10252941	CASE ASSY/REAR	TK-RJK509305*002	0	1	0	CI	C	
N	37	10252932	CASE ASSY/REAR	TK-RJK509305*003	0	0	1	CI	C	

N New parts

*1: Floppy disk is bundled.

*2: Windows media player is included.

*3: Made in China

*4: Made in Japan

N	Item	Parts Code	Parts Name	Specification	QTY			Price Code	R	Remark
					Silver	Red	Blue			
N	38	10251076	STRAP BOARD/A	RJK509273-001V01	1	0	1	AL	C	
N	38	10251082	STRAP BOARD/B	RJK509273-002V01	0	1	0	AL	C	
N	39	10251131	KEY	CA-K837-SE-S	1	1	1	BB	C	
N	40	10251132	TAPE/KEY/A	RJK509241-001V01	1	1	1	AA	C	
N	41	10251133	TAPE/KEY/B	RJK509241-002V01	1	1	1	AA	C	
N	42	10252935	LCD ASSY	TK-RJK509309*001	1	1	1	DH	A	
	43	10260412	RING/CONDUCTIVE	RJK509490-001V03	1	1	1	AA	C	
	44	10261263	TAPE	RJK509629-001V01	4	4	4	AA	C	
	45	10258076	LABEL/RATING/DBA	RJK509326-006V03	1	0	0	Al	X	*3 For US
	45	10258077	LABEL/RATING/DBB	RJK509326-007V03	0	1	0	Al	X	*3 For US
	45	10258078	LABEL/RATING/DBC	RJK509326-008V03	0	0	1	Al	X	*3 For US
	45	10258079	LABEL/RATING/DCA	RJK509326-009V03	1	0	0	Al	X	*3 For EU
	45	10258080	LABEL/RATING/DCB	RJK509326-010V03	0	1	0	Al	X	*3 For EU
	45	10258081	LABEL/RATING/DCC	RJK509326-011V03	0	0	1	Al	X	*3 For EU
	45	10258082	LABEL/RATING/DFA	RJK509326-012V03	1	0	0	Al	X	*3 Except EU/US
	45	10258083	LABEL/RATING/DFB	RJK509326-013V03	0	1	0	Al	X	*3 Except EU/US
	45	10258084	LABEL/RATING/DFC	RJK509326-014V03	0	0	1	Al	X	*3 Except EU/US
	45	10258090	LABEL/RATING/EBA	RJK509326-020V03	1	0	0	Al	X	*4 For US
	45	10258091	LABEL/RATING/EBB	RJK509326-021V03	0	1	0	Al	X	*4 For US
	45	10258092	LABEL/RATING/EBC	RJK509326-022V03	0	0	1	Al	X	*4 For US
	45	10258093	LABEL/RATING/ECA	RJK509326-023V03	1	0	0	Al	X	*4 For EU
	45	10258094	LABEL/RATING/ECB	RJK509326-024V03	0	1	0	Al	X	*4 For EU
	45	10258095	LABEL/RATING/ECC	RJK509326-025V03	0	0	1	Al	X	*4 For EU
	45	10258096	LABEL/RATING/EFA	RJK509326-026V03	1	0	0	Al	X	*4 Except EU/US
	45	10258097	LABEL/RATING/EFB	RJK509326-027V03	0	1	0	Al	X	*4 Except EU/US
	45	10258098	LABEL/RATING/EFB	RJK509326-028V03	0	0	1	Al	X	*4 Except EU/US
	S1	10203893	SCREW	RJK502836-011V01	4	4	4	AA	X	
	S2	10226146	SCREW	RJK508552-001V01	2	2	2	AA	X	
N	S3	10254784	SCREW	RJK502836-015V02	2	2	2	AA	X	
	S4	10081372	SCREW	RJK502836-001V01	4	4	4	AA	X	
	S5	10153233	SCREW	RJK506113-001V01	1	1	1	AA	X	
	S6	10170415	SCREW	RJK506541-001V01	3	3	3	AA	X	
	FU100	10196218	FUSE	FCC10801ABPA	1	1	1	AA	B	
	FU101	10137134	FUSE	FHC10252ABPA	1	1	1	AA	B	
ACCESSORIES										
N	-	10252947	CD ROM	CK837DCA01R	1	1	1	AM	C	For EU/UK
N	-	10253763	CD ROM	CK837DCA02R	1	1	1	AM	C	*2 For EU/UK
N	-	10253761	CD ROM	CK837DBA01R	1	1	1	AM	C	Except EU/UK
N	-	10253762	CD ROM	CK837DBA02R	1	1	1	AM	C	*2 Except EU/UK
	-	10242037	AV CABLE	AV-K800-BK15	1	1	1	AJ	C	
	-	10235765	USB CABLE	UC-K815-BK10-MB	1	1	1	Al	C	
	-	10210351	AC CORD	CBL-K835-AC-EU-06	1	1	1	AF	C	EU type
	-	10210360	AC CORD	CBL-K835-AC-TW-06	1	1	1	AF	C	Blade type
	-	10210354	AC CORD	CBL-K835-AC-UK-06	1	1	1	AR	C	UK type
	-	10250160	AC CORD	CBL-K835-AC-US-06	1	1	1	AH	C	US type
N	-	10250508	AC ADAPTOR	AD6008CJ	1	1	1	AZ	C	
N	-	10250507	CRADLE	WAU0990-012AE	1	1	1	CB	C	
N	-	10251924	BATTER/LI-ION	MK11-2855-U-S	1	1	1	BX	B	For US
	-	10244922	BATTER/LI-ION	MK11-2855	1	1	1	BS	B	Except US
	-	10187367	STRAP	ST-K872-S	1	1	1	AB	X	

N New parts

*1: Floppy disk is bundled.

*2: Windows media player is included.

*3: Made in China

*4: Made in Japan

PRINTED CIRCUIT BOARD

MAIN PCB (TOP VIEW)

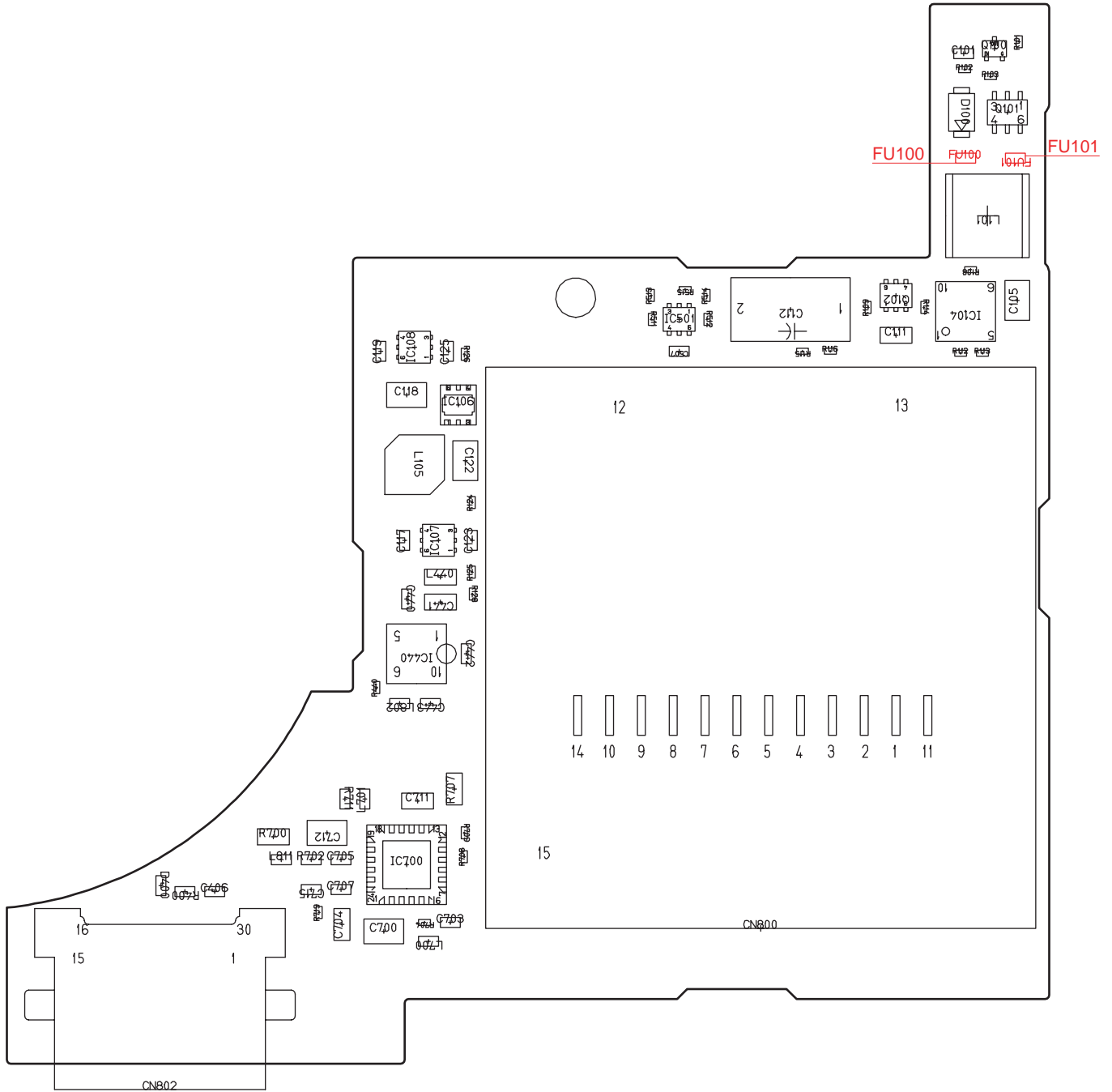

MAIN PCB (BOTTOM VIEW)

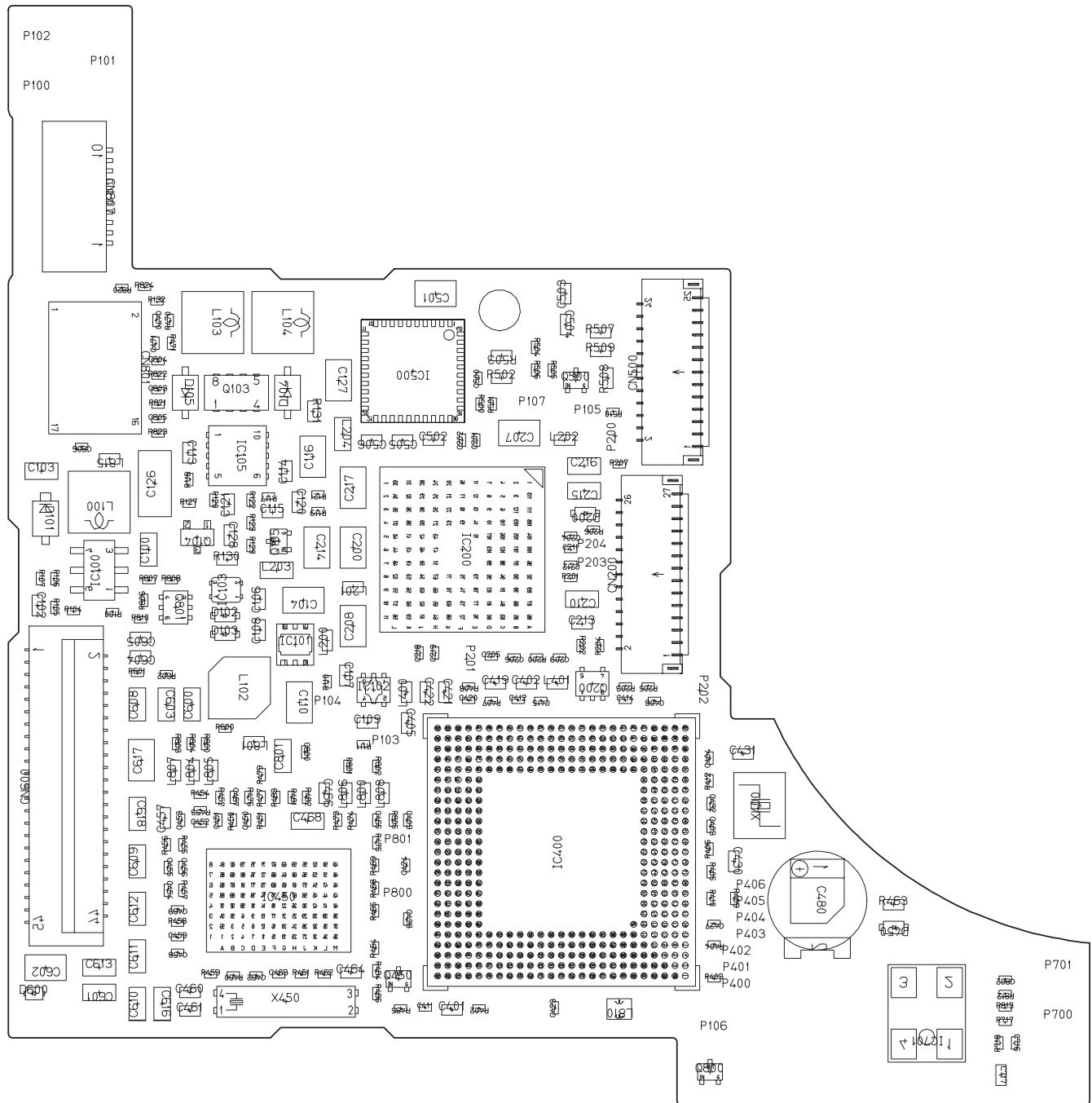

MAIN PCB (2/3)

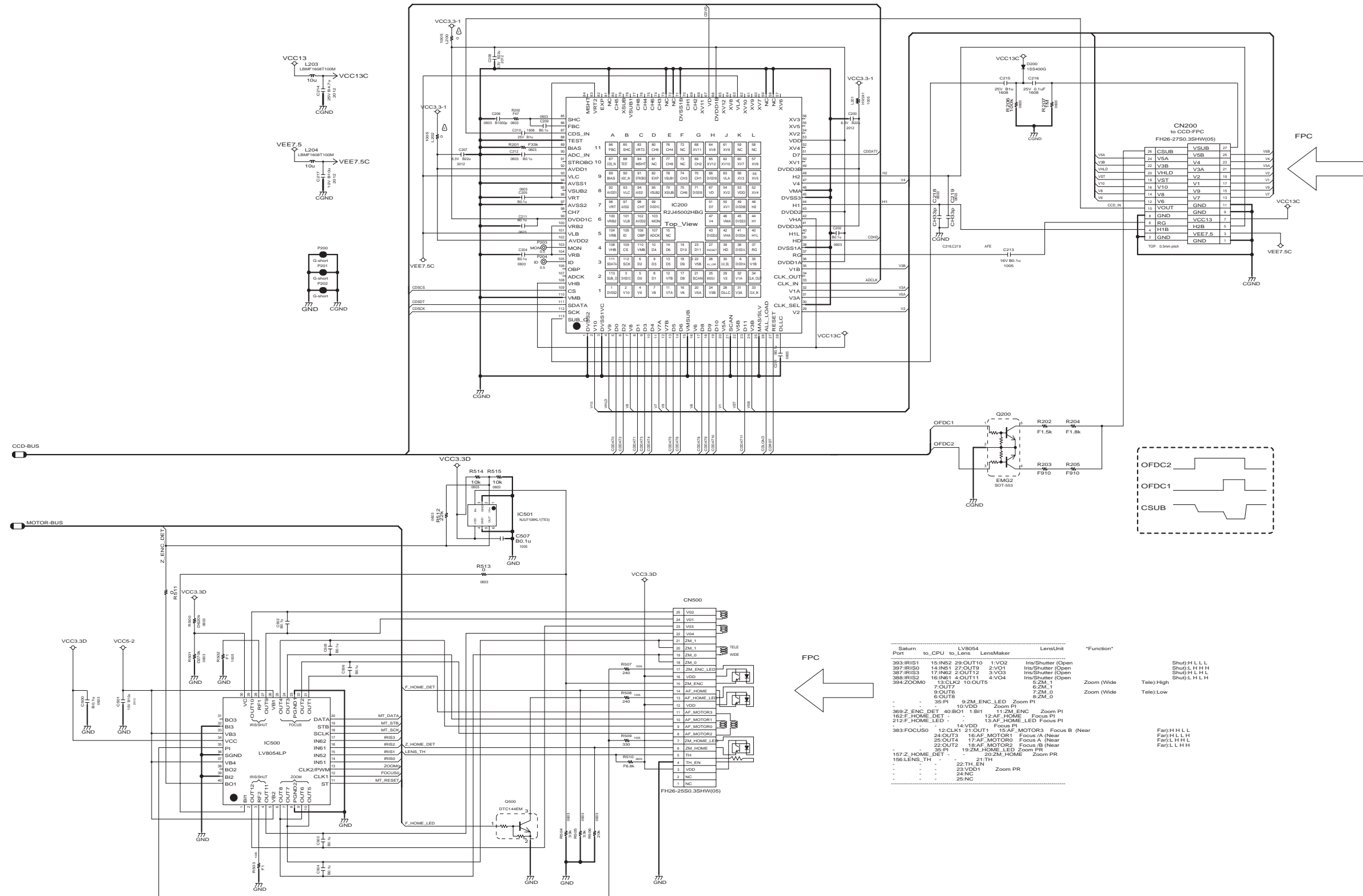

MAIN PCB (3/3)

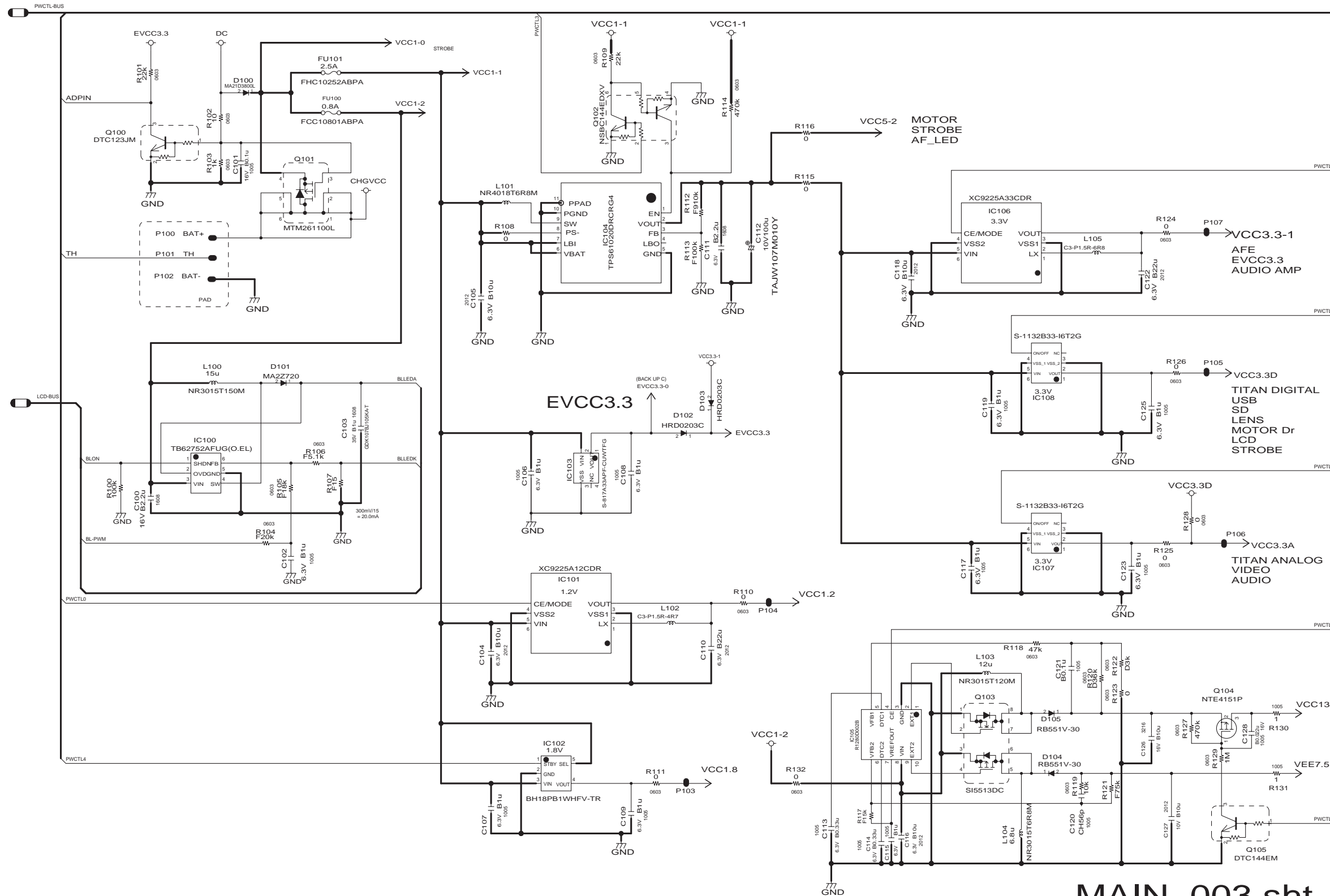

MAIN_003.sht

Ver.1 : Sep. 2006

- Correction of the EXPLODED VIEW (P37)
- Correction of the PARTS LIST (P39)

Ver.2 : Oct. 2006

- The program for EX-S770 has been changed. (P6 to P9)
- Correction of the PARTS LIST (P39)

CASIO COMPUTER CO.,LTD.
Overseas Service Division

6-2, Hon-machi 1-Chome
Shibuya-ku, Tokyo 151-8543, Japan