

Step-up DC / DC Converter with Overcurrent Protection

NO.EA-272-230928

OUTLINE

The R1205x is a PWM control type step-up DC/DC converter IC with low supply current. Each of these ICs consists of an NMOS FET, a diode, an oscillator, a PWM comparator, a voltage reference unit, an error amplifier, a current limit circuit, an under voltage lockout circuit (UVLO), an over-voltage protection circuit (OVP), a soft-start circuit, a Maxduty limit circuit, and a thermal shutdown protection circuit. This step-up DC/DC converter can be easily built with a few external components such as a coil, a resistor, and a capacitor. As the protection functions, the R1205x has an Lx peak current limit function, an over voltage protection (OVP) function, an under voltage lock out (UVLO) function and a thermal shutdown function.

The R1205x presents the R1205x8xxA version that is optimized for the constant voltage power source, and the R1205x8xxB/C version that is optimized for driving the white LED with the constant current. The R1205x8xxB/C is an adjustable version that can change the LED brightness dynamically by using a 200Hz to 300kHz PWM signal toward the CE pin.

The R1205x is available in DFN1616-6B and TSOT-23-6 packages.

FEATURES

- Input Voltage Range 2.3V to 5.5V (R1205x8xxA)
1.8V to 5.5V (R1205x8xxB/C)
- Supply Current Typ. 800 μ A
- Standby Current Max. 5 μ A
- Feedback Voltage 1.0V \pm 15mV (R1205x8xxA)
0.2V \pm 10mV (R1205x8xxB)
0.4V \pm 10mV (R1205x8xxC)
- Oscillator Frequency Typ. 1.2MHz
- Maximum Duty Cycle Typ. 91%
- UVLO Function Typ.2.0V (Hys.Typ.0.2V) (R1205x8xxA)
Typ.1.6V (Hys.Typ.0.1V) (R1205x8xxB/C)
- Selectable Lx Current Limit Function Typ. 350mA / 700mA
- Over Voltage Protection Typ. 25V
- LED dimming control (R1205x8xxB/C)by external PWM signal (Frequency 200Hz to 300kHz)
- Thermal Protection Function Typ.150 $^{\circ}$ C(Hys.Typ.50 $^{\circ}$ C)
- Switch ON Resistance Typ. 1.35 Ω
- Packages DFN1616-6B, TSOT-23-6
- Ceramic capacitors are recommended

APPLICATION

- Constant Voltage Power Source for portable equipment
- OLED power supply for portable equipment
- White LED Backlight for portable equipment

SELECTION GUIDE

The OVP threshold voltage, current limit, package and V_{FB} /Auto discharge are user-selectable options.

Product Name	Package	Quantity per Reel	Pb Free	Halogen Free
R1205L8x1*-TR	DFN1616-6B	5,000 pcs	Yes	Yes
R1205N8x3*-TR-FE	TSOT-23-6	3,000 pcs	Yes	Yes

x : Designation of current limit.

(1) 350mA

(2) 700mA

* : Designation of VFB.

(A) 1.0V

(B) 0.2V

(C) 0.4V

BLOCK DIAGRAMS

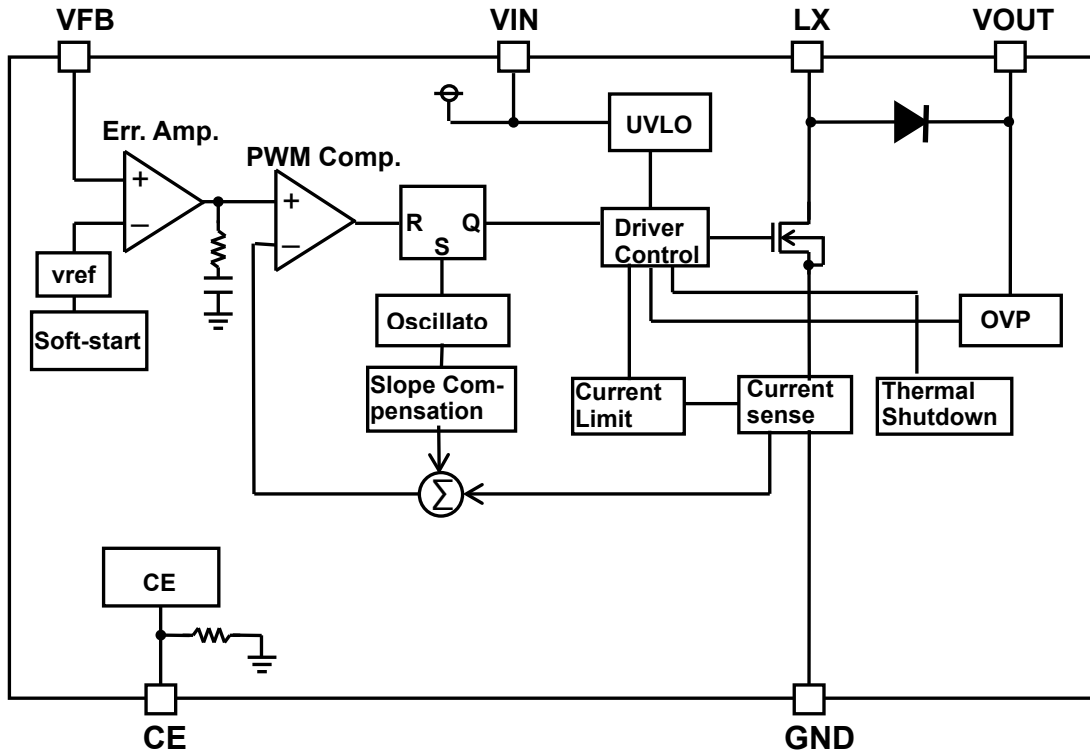

R1205x8xxA

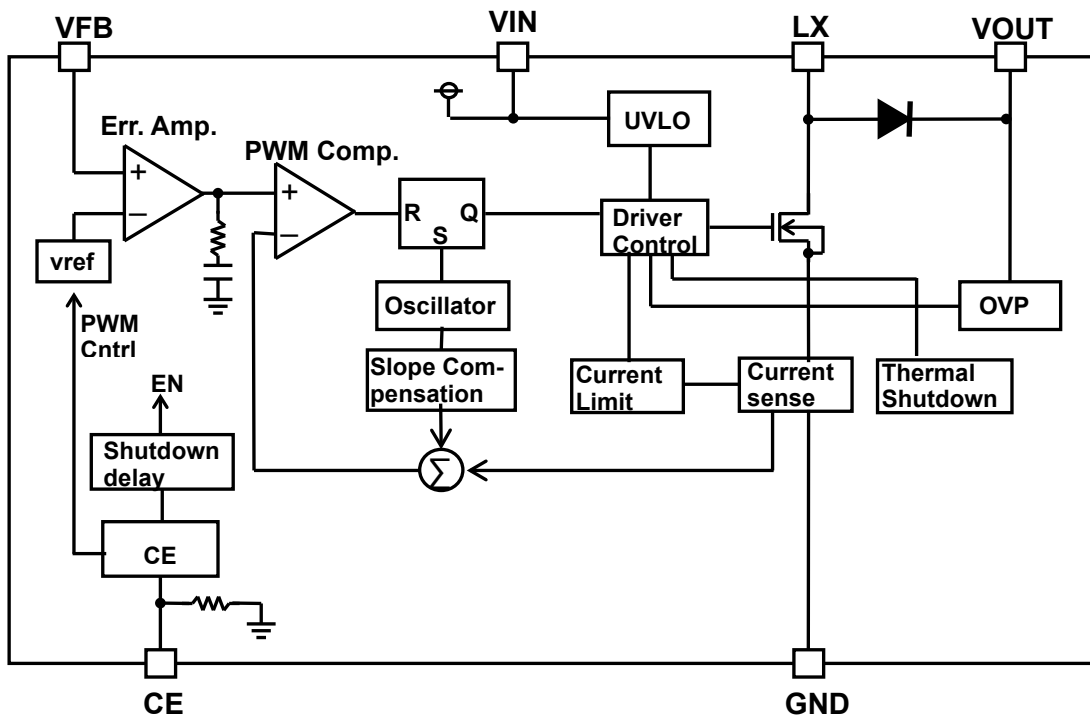

R1205x8xxB/C

PIN DESCRIPTIONS

DFN1616-6B

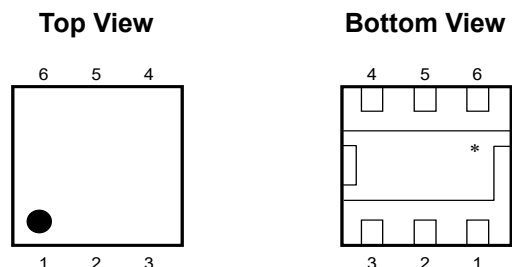

TSOT-23-6

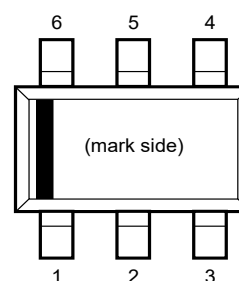

DFN1616-6B

Pin No	Symbol	Pin Description
1	CE	Chip Enable Pin ("H" Active)
2	VFB	Feedback Pin
3	LX	Switching Pin (Open Drain Output)
4	GND	Ground Pin
5	VIN	Input Pin
6	VOUT	Output Pin

* The tab is substrate level (GND). The tab is better to be connected to the GND, but leaving it open is also acceptable.

TSOT-23-6

Pin No	Symbol	Pin Description
1	CE	Chip Enable Pin ("H" Active)
2	VOUT	Output Pin
3	VIN	Input Pin
4	LX	Switching Pin (Open Drain Output)
5	GND	Ground Pin
6	VFB	Feedback Pin

ABSOLUTE MAXIMUM RATINGS

GND=0V

Symbol	Item		Rating	Unit
V_{IN}	VIN Pin Voltage		-0.3 to 6.5	V
V_{CE}	CE Pin Voltage		-0.3 to 6.5	V
V_{FB}	VFB Pin Voltage		-0.3 to 6.5	V
V_{OUT}	VOUT Pin Voltage		-0.3 to 28	V
V_{LX}	LX Pin Voltage		-0.3 to 28	V
I_{LX}	LX Pin Current		1000	mA
P_D	Power Dissipation ⁽¹⁾	DFN1616-6B (JEDEC STD. 51-7 Test Land Pattern)	2400	mW
		TSOT-23-6 (Standard Test Land Pattern)	460	
T_j	Junction Temperature Range		-40 to 125	°C
T_{stg}	Storage Temperature Range		-55 to 125	°C

ABSOLUTE MAXIMUM RATINGS

Electronic and mechanical stress momentarily exceeded absolute maximum ratings may cause permanent damage and may degrade the life time and safety for both device and system using the device in the field. The functional operation at or over these absolute maximum ratings are not assured.

RECOMMENDED OPERATING CONDITIONS

Symbol	Item	Rating	Unit
V_{IN}	Input Voltage (R1205x8xxA)	2.3 to 5.5	V
	Input Voltage (R1205x8xxB/C)	1.8 to 5.5	
T_a	Operating Temperature Range	-40 to 85	°C

RECOMMENDED OPERATING CONDITIONS

All of electronic equipment should be designed that the mounted semiconductor devices operate within the recommended operating conditions. The semiconductor devices cannot operate normally over the recommended operating conditions, even if they are used over such ratings by momentary electronic noise or surge. And the semiconductor devices may receive serious damage when they continue to operate over the recommended operating conditions.

⁽¹⁾ Refer to *POWER DISSIPATION* for detailed information.

ELECTRICAL CHARACTERISTICS

R1205x

(Ta=25°C)

Symbol	Item	Conditions	Min.	Typ.	Max.	Unit	
I _{DD}	Supply Current	V _{IN} =5.5V, V _{FB} =0V, L _X at no load		0.8	1.2	mA	
I _{standby}	Standby Current	V _{IN} =5.5V, V _{CE} =0V		1.0	5.0	μA	
V _{UVLO1}	UVLO Detector Threshold	V _{IN} falling	R1205x8xxA	1.9	2.0	2.1	V
			R1205x8xxB/C	1.5	1.6	1.7	
V _{UVLO2}	UVLO Released Voltage	V _{IN} rising	R1205x8xxA		V _{UVLO1} +0.2	2.3	V
			R1205x8xxB/C		V _{UVLO1} +0.1	1.8	
V _{CEH}	CE Input Voltage "H"	V _{IN} =5.5V	1.5			V	
V _{CEL}	CE Input Voltage "L"				0.5	V	
R _{CE}	CE Pull Down Resistance			1200		kΩ	
V _{FB}	V _{FB} Voltage Accuracy	V _{IN} =3.6V	R1205x8xxA	0.985	1.000	1.015	V
			R1205x8xxB	0.19	0.2	0.21	
			R1205x8xxC	0.39	0.4	0.41	
$\frac{\Delta V_{FB}}{\Delta T_a}$	V _{FB} Voltage Temperature Coefficient	V _{IN} =3.6V, -40°C ≤ T _a ≤ 85°C		±150		ppm/°C	
I _{FB}	V _{FB} Input Current	V _{IN} =5.5V, V _{FB} =0V or 5.5V	-0.1		0.1	μA	
t _{start}	Soft-start Time	R1205x8xxA		2.0	3.0	ms	
R _{ON}	FET ON Resistance	I _{LX} =100mA		1.35		Ω	
I _{OFF}	FET Leakage Current	V _{LX} =24V			3.0	μA	
I _{LIM}	FET Current Limit		R1205x81xx	250	350	450	mA
			R1205x82xx	500	700	900	
V _F	Diode Forward Voltage	I _{SW} =100mA		0.8		V	
I _{DIODEleak}	Diode Leakage Current	V _{OUT} =24V, V _{LX} =0V			10	μA	
f _{osc}	Oscillator Frequency	V _{IN} =3.6V, V _{FB} =0V	1000	1200	1400	kHz	
Maxduty	Maximum Duty Cycle	V _{IN} =3.6V, V _{FB} =0V	86	91		%	
V _{OVP1}	OVP Detect Voltage	V _{IN} =3.6V, V _{OUT} rising	24.2	25	25.8	V	
V _{OVP2}	OVP Release Voltage	V _{IN} =3.6V, V _{OUT} falling		V _{OVP1} -1.8		V	
T _{TSD}	Thermal Shutdown Detect Temperature	V _{IN} =3.6V		150		°C	
T _{TSR}	Thermal Shutdown Release Temperature	V _{IN} =3.6V		100		°C	

THEORY OF OPERATION

Operation of Step-Up DC/DC Converter and Output Current

<Basic Circuit>

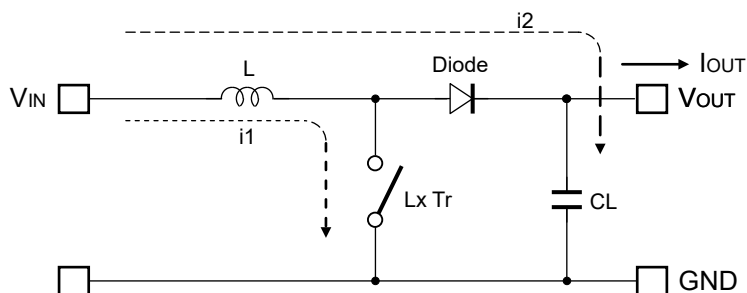

<Current through L>

Discontinuous mode

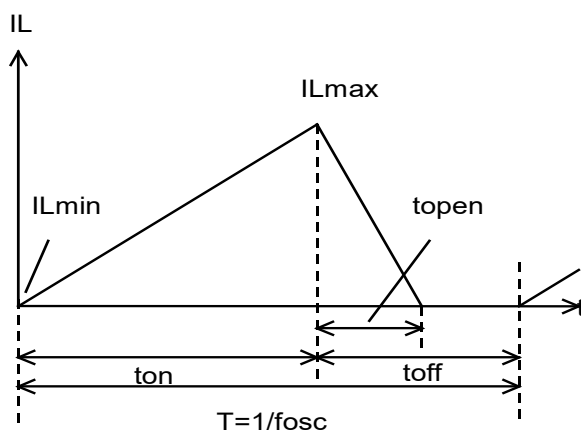

Continuous mode

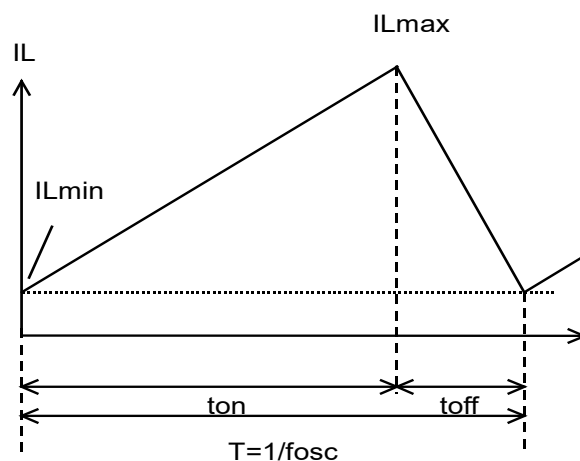

There are two operation modes of the step-up PWM control-DC/DC converter. That is the continuous mode and discontinuous mode by the continuousness inductor.

When the transistor turns ON, the voltage of inductor L becomes equal to V_{IN} voltage. The increase value of inductor current (i_1) will be

$$\Delta i_1 = V_{IN} \times t_{on} / L \dots \dots \dots \text{Formula 1}$$

As the step-up circuit, during the OFF time (when the transistor turns OFF) the voltage is continually supply from the power supply. The decrease value of inductor current (i_2) will be

$$\Delta i_2 = (V_{OUT} - V_{IN}) \times t_{open} / L \dots\dots\dots \text{Formula 2}$$

At the PWM control-method, the inductor current become continuously when $t_{open}=t_{off}$, the DC/DC converter operate as the continuous mode.

In the continuous mode, the variation of current of i_1 and i_2 is same at regular condition.

$$V_{IN} \times t_{on} / L = (V_{OUT} - V_{IN}) \times t_{off} / L \dots\dots\dots \text{Formula 3}$$

The duty at continuous mode will be

$$\text{duty (\%)} = t_{on} / (t_{on} + t_{off}) = (V_{OUT} - V_{IN}) / V_{OUT} \dots\dots\dots \text{Formula 4}$$

The average of inductor current at $t_f = t_{off}$ will be

$$I_{L(\text{Ave.})} = V_{IN} \times t_{on} / (2 \times L) \dots\dots\dots \text{Formula 5}$$

If the input voltage = output voltage, the I_{OUT} will be

$$I_{OUT} = V_{IN}^2 \times t_{on} / (2 \times L \times V_{OUT}) \dots\dots\dots \text{Formula 6}$$

If the I_{OUT} value is large than above the calculated value (Formula 6), it will become the continuous mode, at this status, the peak current (I_{Lmax}) of inductor will be

$$I_{Lmax} = I_{OUT} \times V_{OUT} / V_{IN} + V_{IN} \times t_{on} / (2 \times L) \dots\dots\dots \text{Formula 7}$$

$$I_{Lmax} = I_{OUT} \times V_{OUT} / V_{IN} + V_{IN} \times T \times (V_{OUT} - V_{IN}) / (2 \times L \times V_{OUT}) \dots\dots\dots \text{Formula 8}$$

The peak current value is larger than the I_{OUT} value. In case of this, selecting the condition of the input and the output and the external components by considering of I_{Lmax} value.

The explanation above is based on the ideal calculation, and the loss caused by L_x switch and the external components are not included.

The actual maximum output current will be between 50% and 80% by the above calculations. Especially, when the I_L is large or V_{IN} is low, the loss of V_{IN} is generated with on resistance of the switch. Moreover, it is necessary to consider V_f of the diode (approximately 0.8V) about V_{OUT} .

Soft-Start (R1205x8xxA)

The output and reference of the error amplifier start from 0V and the reference gradually rises up to 1.0V. After the softstart time (TSS), output voltage rise up to the setting voltage.

The output of the error amplifier starts from 0V and the inrush current is suppressed when starting by the CE pin "H" input. Moreover, the inrush current can be suppressed by gradually enlarging Duty of the PWM signal to the CE pin.

Current Limit Function

Current limit function monitors the over current and if it reaches the peak current, it will turn off the driver. When the over current decreases, it will restart oscillation and will restart the monitoring.

APPLICATION INFORMATION

Typical Applications

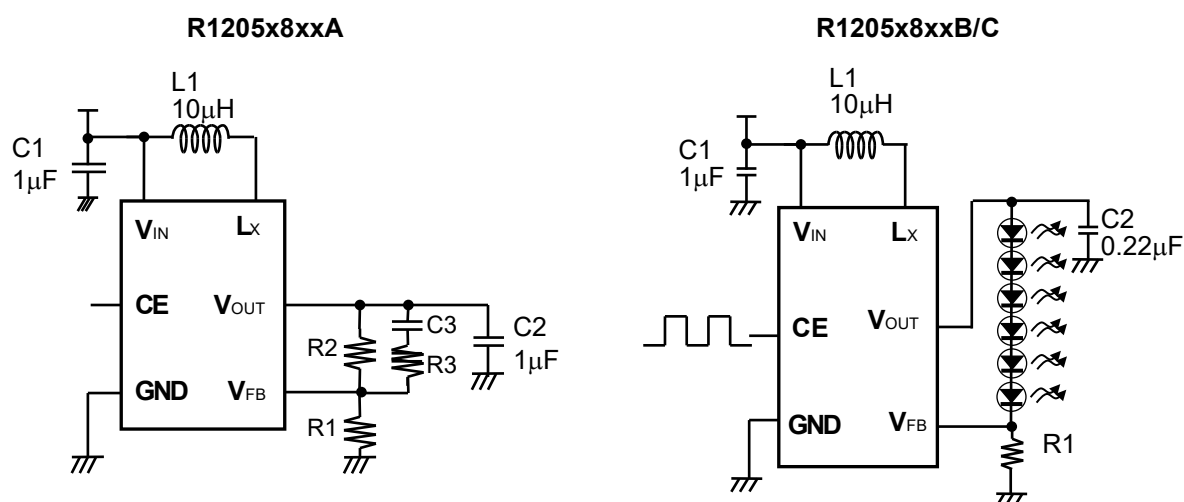

Inductor Selection

The peak current of the inductor at normal mode can be estimated as the next formula when the efficiency is 80%.

$$I_{Lmax} = 1.25 \times I_{OUT} \times V_{OUT} / V_{IN} + 0.5 \times V_{IN} \times (V_{OUT} - V_{IN}) / (L \times V_{OUT} \times f_{osc})$$

In the case of start-up or dimming control by CE pin, inductor transient current flows, and the peak current of it must be equal or less than the current limit of the IC. The peak current should not beyond the rated current of the inductor.

The recommended inductance value is 10µH - 22µH.

Table 1 Peak current value in each condition

Condition				
V _{IN} (V)	V _{OUT} (V)	I _{OUT} (mA)	L (µH)	I _{Lmax} (mA)
3	14	20	10	215
3	14	20	22	160
3	21	20	10	280
3	21	20	22	225

Table 2 Recommended inductors

L (µH)	Part No.	Rated Current (mA)	Size (mm)
10	LQH32CN100K53	450	3.2x2.5x1.55
10	LQH2MC100K02	225	2.0x1.6x0.9
10	VLF3010A-100	490	2.8x2.6x0.9
10	VLS252010-100	520	2.5x2.0x1.0
22	LQH32CN220K53	250	3.2x2.5x1.55
22	LQH2MC220K02	185	2.0x1.6x0.9
22	VLF3010A-220	330	2.8x2.6x0.9

Capacitor Selection

Set 1 μ F or more value bypass capacitor C1 between V_{IN} pin and GND pin as close as possible.

R1205xxxxA

Set 1 μ F – 4.7 μ F or more capacitor C2 between V_{OUT} and GND pin.

Table 3-A Recommended components for R1205xxxxA

	Rated voltage(V)	Part No.
C1	6.3	CM105B105K06
C2	25	GRM21BR11E105K
C3	25	22pF
R1		For V _{OUT} Setting
R2		For V _{OUT} Setting
R3		2k Ω

If the transient drop of output voltage by the load fluctuation is large and exceeds the allowable range in above setting, refer to Table 3-B to change the capacitors of C2 and C3 for the response improvement and the transient voltage drop reduction.

Table 3-B Recommended components for R1205xxxxA

	Rated voltage(V)	Part No.
C1	6.3	CM105B105K06
C2	50	GRM31CR71H475M
C3	25	220pF
R1		For V _{OUT} Setting
R2		For V _{OUT} Setting
R3		2k Ω

R1205xxxxB/C

Set 0.22 μ F or more capacitor C2 between V_{OUT} and GND pin. (R1205x8xxB)

Set 0.47 μ F or more capacitor C2 between V_{OUT} and GND pin. (R1205x8xxC)

Note the V_{OUT} that depends on LED used, and select the rating of V_{OUT} or more.

Table 4 Recommended components for R1205xxxxB/C

	Rated voltage(V)	Part No.
C1	6.3	CM105B105K06
C2	25	GRM21BR11E224
	25	C2012X7R1E474K
	50	GRM21BR71H224

External Components Setting

If the V_{OUT} spike noise is high, it may influence on the V_{FB} pin to cause the operation of R1205x8xxA unstable. To reduce the noise coming into V_{FB} pin, please place a 1k Ω to 5k Ω resistor in R3 in Fig. 1.

Application of Using 5.5V or more Power Supply

Other than the IC power supply, if there is a power supply greater than 5.5V, the high power output can be achieved by using the power supply as an inductor power supply. In this case, please place a capacitor between an inductor power supply and GND (shown in Fig. 2) aside from a bypass capacitor between the V_{IN} pin and GND of the IC.

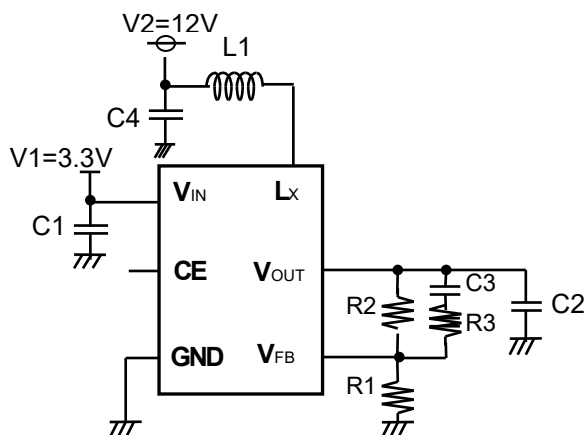

Fig. 1 R1205x8xxA

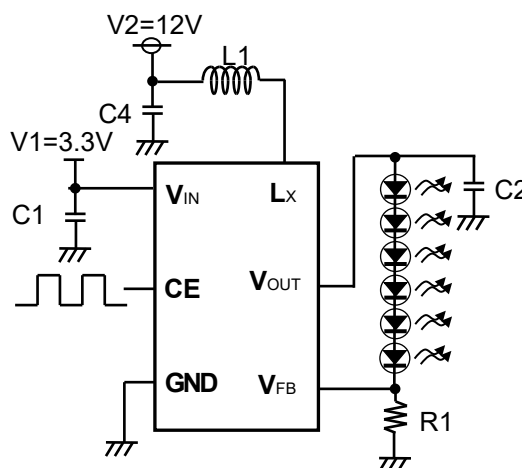

Fig. 2 R1205x8xxB/C

The Method of Output Voltage Setting (R1205x8xxA)

The output voltage (V_{OUT}) can be calculated with divider resistors ($R1$ and $R2$) values as the following formula:

$$\text{Output Voltage } (V_{OUT}) = V_{FB} \times (R1 + R2) / R1$$

The total value of $R1$ and $R2$ should be equal or less than 300k Ω . Make the V_{IN} and GND line sufficient. The large current flows through the V_{IN} and GND line due to the switching. If this impedance (V_{IN} and GND line) is high, the internal voltage of the IC may shift by the switching current, and the operating may become unstable. Moreover, when the built-in Lx switch is turn OFF, the spike noise caused by the inductor may be generated.

LED Current setting (R1205x8xxB/C)

When CE pin input is "H" (Duty=100%), LED current can be set with feedback resistor ($R1$)

$$I_{LED} = V_{FB} / R1$$

LED Dimming Control (R1205x8xxB/C)

The LED brightness can be controlled by inputting the PWM signal to the CE pin. If the CE pin input is "L" in the fixed time (Typ.0.5ms), the IC becomes the standby mode and turns OFF LEDs.

The current of LEDs can be controlled by Duty of the PWM signal of the input CE pin. The current of LEDs when High-Duty of the CE input is "Hduty" reaches the value as calculatable following formula.

$$I_{LED} = Hduty \times V_{FB} / R1$$

The frequency of the PWM signal is using the range between 200Hz to 300kHz.

When controlling the LED brightness by the PWM signal of 5kHz or less, R1205x8xxB/C are recommended to avoid discharge function during dimming control.

When controlling the LED brightness by the PWM signal of 20kHz or less, the increasing or decreasing of the inductor current might be make a sounds in the hearable sound wave area. In that case, please use the PWM signal in the high frequency area.

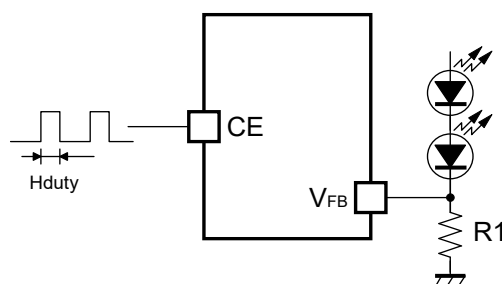

Dimming Control by CE Pin Input

I_{LED} accuracy (R1205x8xxB / R1205x8xxC)

LED current (I_{LED}) is affected by the offset voltage of the error amplifier in the DC/DC converter.

LED might turn off due to the offset voltage variation, when brightness is controlled by low PWM duty cycle.

In case of R1205x8xxB, it is recommended to input PWM signal that has 18.5% or more duty.

In case of lower duty cycle than 18.5%, it is recommended to use R1205x8xxC.

The table below shows the I_{LED} accuracy of R1205x8xxC at low PWM duty cycle input (low brightness).

I_{LED} accuracy when low PWM Duty is applied (R1 = 20 Ω)

	PWM Duty applied to CE Pin	I_{LED} Min.	I_{LED} Max.
R1205x8xxC	3.5% (Frequency = 20kHz to 300kHz)	0.01mA ⁽¹⁾	2.1mA ⁽¹⁾

⁽¹⁾ Design guaranteed value (Ta = 25 °C)

TECHNICAL NOTES

● Current Path on PCB

The current paths in an application circuit are shown in Fig. 3 and 4.

A current flows through the paths shown in Fig. 3 at the time of MOSFET-ON, and shown in Fig. 4 at the time of MOSFET-OFF. In the paths pointed with red arrows in Fig. 4, current flows just in MOSFET-ON period or just in MOSFET-OFF period. Parasitic impedance / inductance and the capacitance of these paths influence stability of the system and cause noise outbreak. So please minimize this side effect. In addition, please shorten the wiring of other current paths shown in Fig. 3 and 4 except for the paths of LED load.

● Layout Guide for PCB

- Please shorten the wiring of the input capacitor (C1) between V_{IN} pin and GND pin of IC. The GND pin should be connected to the strong GND plane.
- The area of L_x land pattern should be smaller.
- Please put output capacitor (C2) close to the V_{OUT} pin.
- Please make the GND side of output capacitor (C2) close to the GND pin of IC.

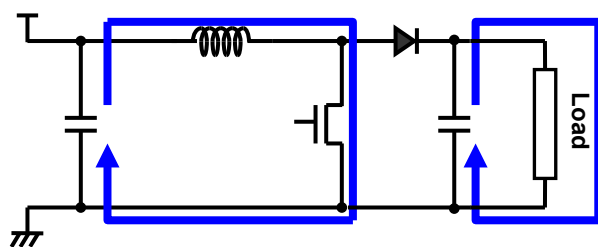

Fig. 3 MOSFET-ON

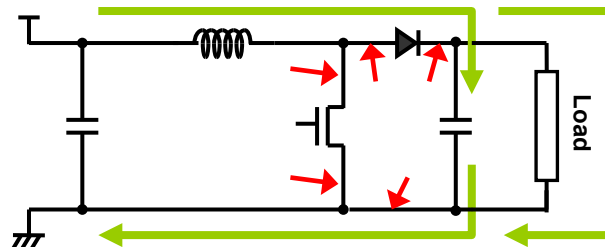
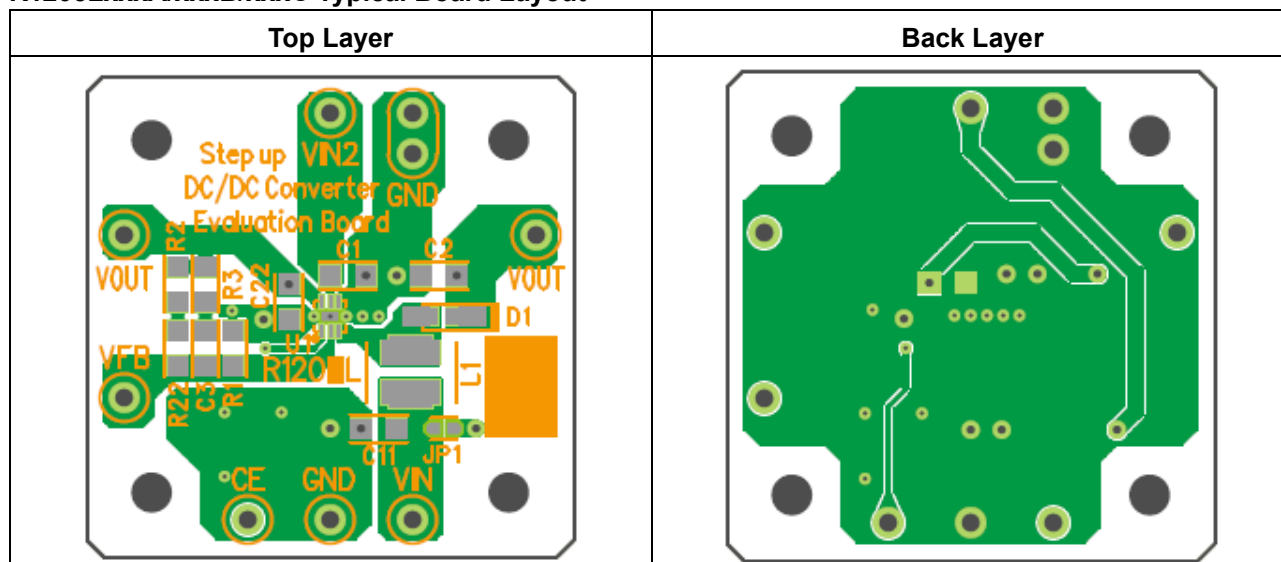

Fig. 4 MOSFET-OFF

● PCB Layout

PKG: DFN1616-6B pin

R1205LxxxA/xxxB/xxxC Typical Board Layout



• PKG:TSOT-23-6pin

R1205NxxxA/xxxB/xxxC Typical Board Layout

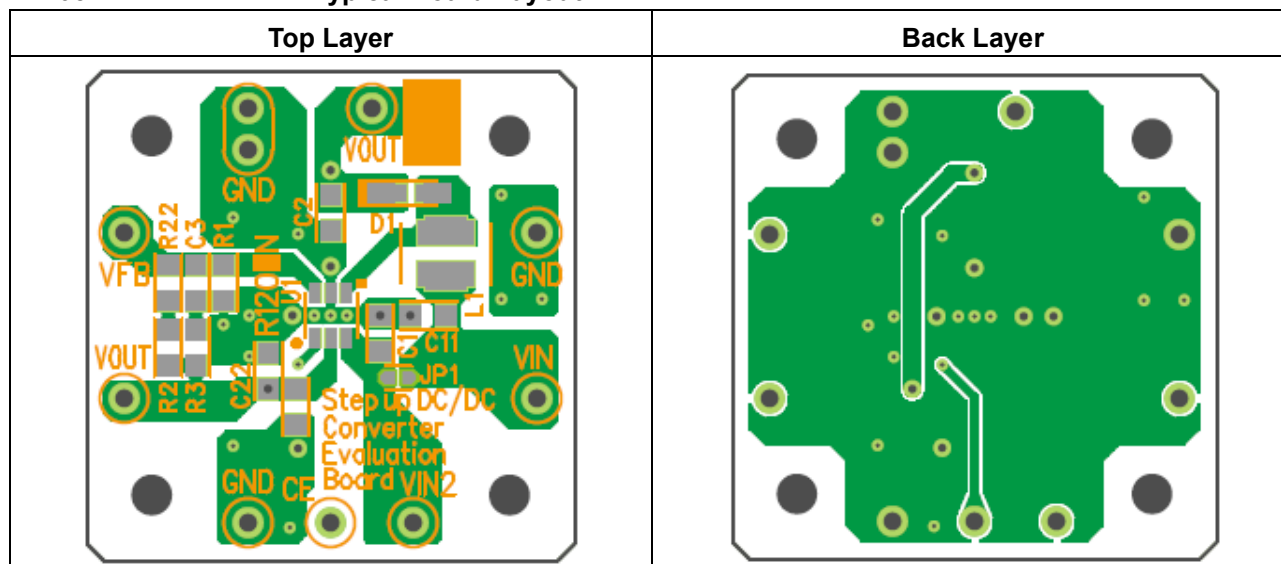

U1-● indicates the position of No.1 pin.

TYPICAL CHARACTERISTICS

1) Efficiency vs. Output Current Characteristics (R1205N823A)

$V_{OUT}=10V, L=10\mu H$ (LQH32CN100K53)

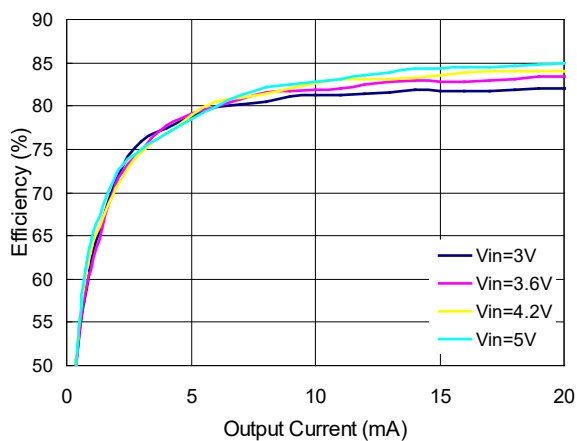

$V_{OUT}=10V, L=22\mu H$ (LQH32CN220K53)

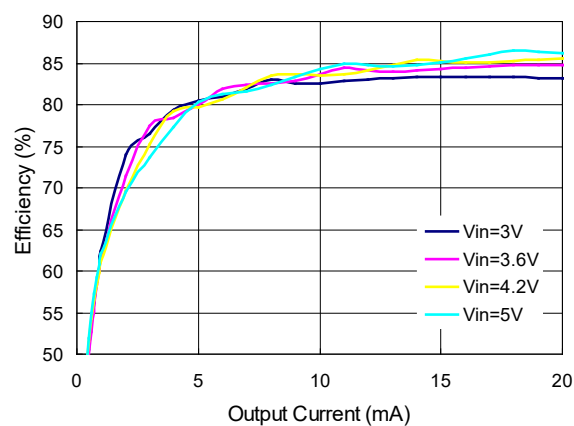

$V_{OUT}=15V, L=10\mu H$ (LQH32CN100K53)

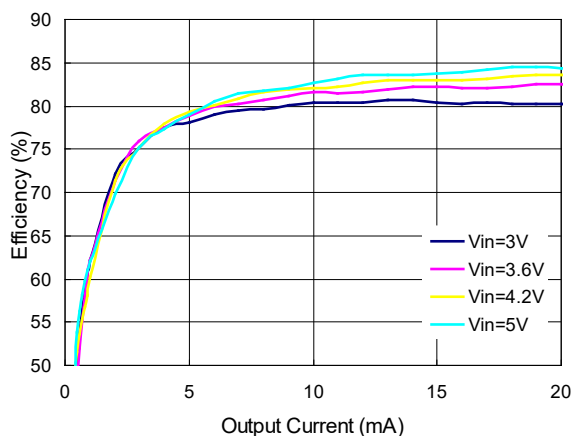

$V_{OUT}=15V, L=22\mu H$ (LQH32CN220K53)

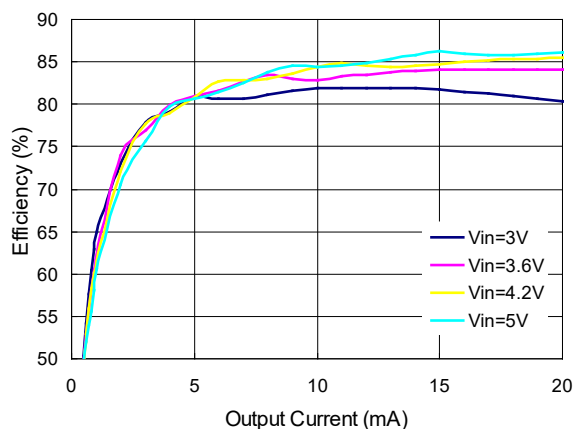

$V_{OUT}=20V, L=10\mu H$ (LQH32CN100K53)

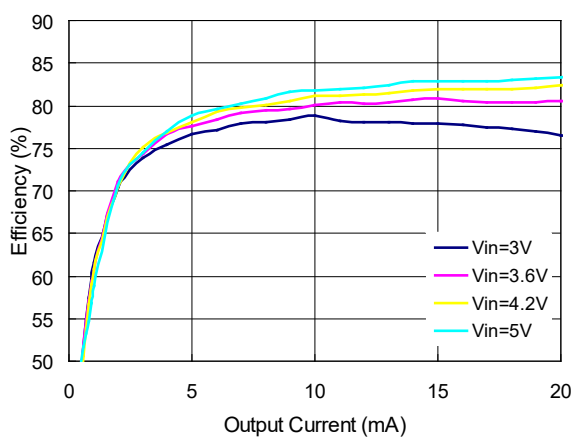

$V_{OUT}=20V, L=22\mu H$ (LQH32CN220K53)

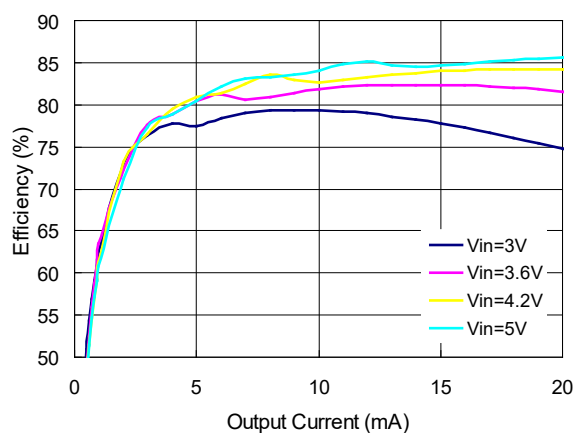

V_{OUT}=20V, V_{IN}=3.6V

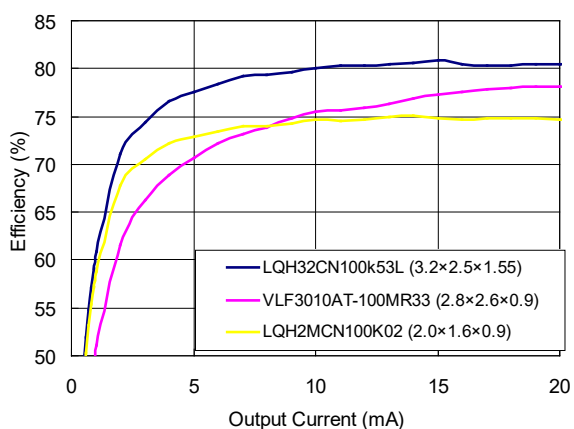

Typical Applications with Using 5.5V or Greater

V_{OUT}=15V, L=10μH (LQH32CN100K53)

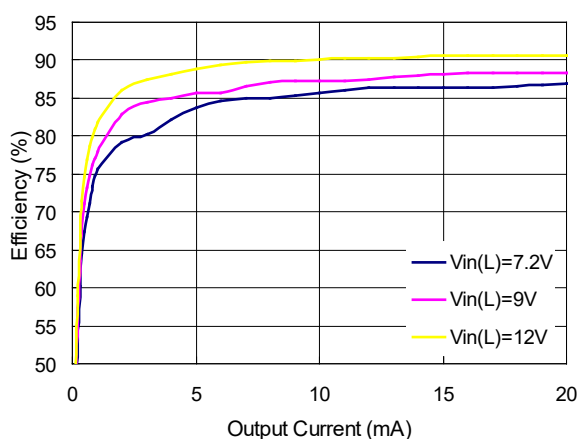

V_{OUT}=20V, L=10μH (LQH32CN100K53)

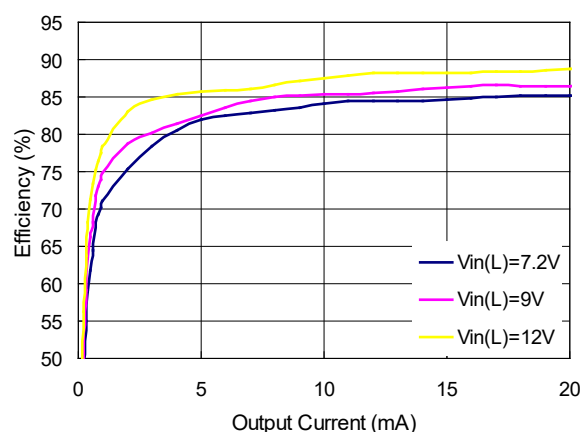

2) Efficiency vs. Output Current Characteristics (R1205N823B/C)

4LED, L=10μH (LQH32CN100K53)

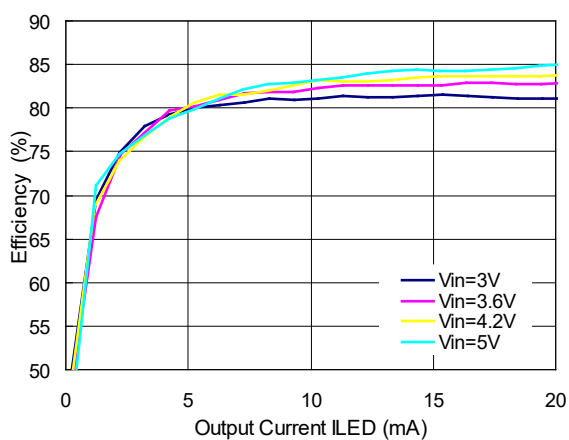

4LED, L=22μH (LQH32CN220K53)

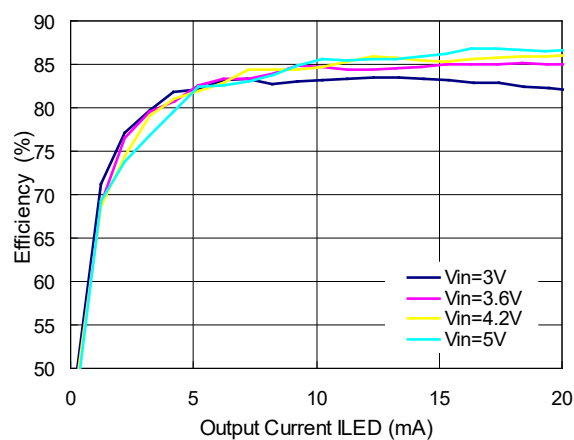

5LED, L=10 μ H (LQH32CN100K53)

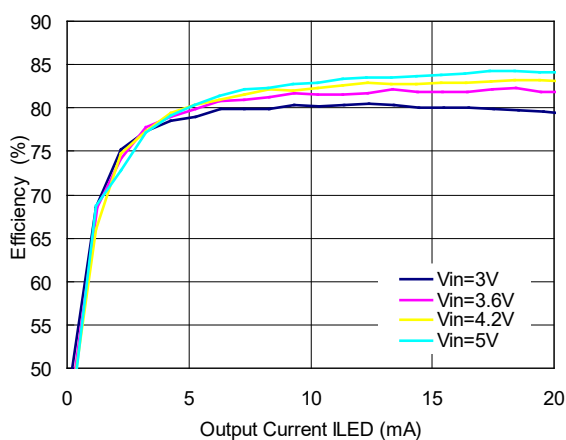

5LED, L=22 μ H (LQH32CN220K53)

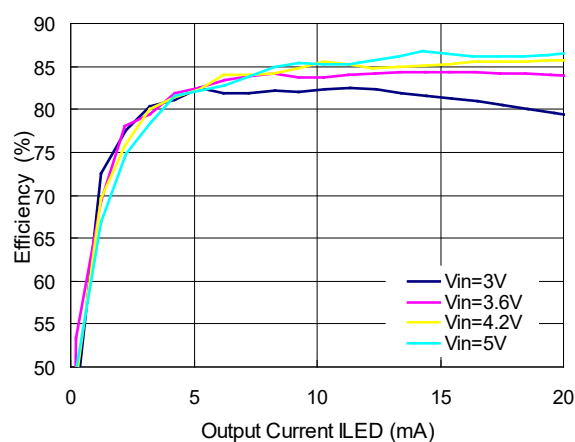

6LED, L=10 μ H (LQH32CN100K53)

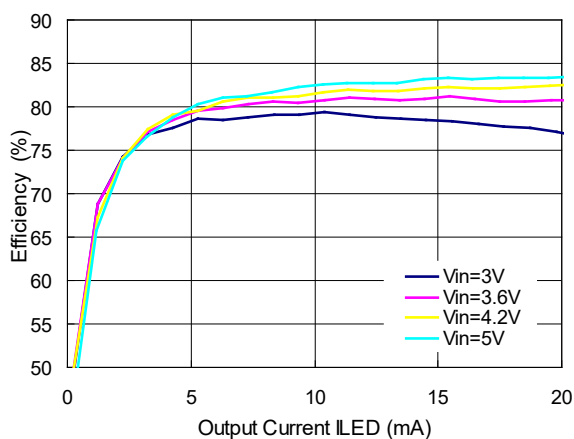

6LED, L=22 μ H (LQH32CN220K53)

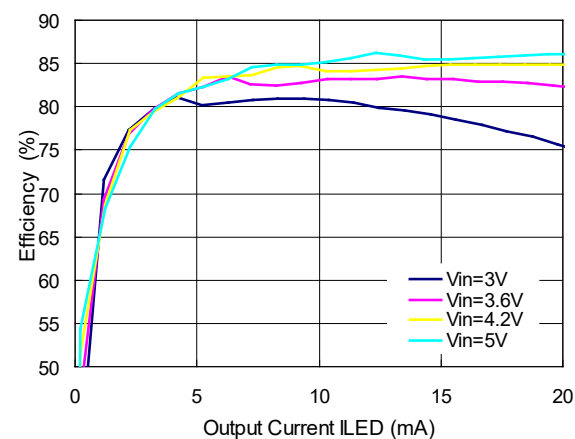

6LED, VIN=3.6V

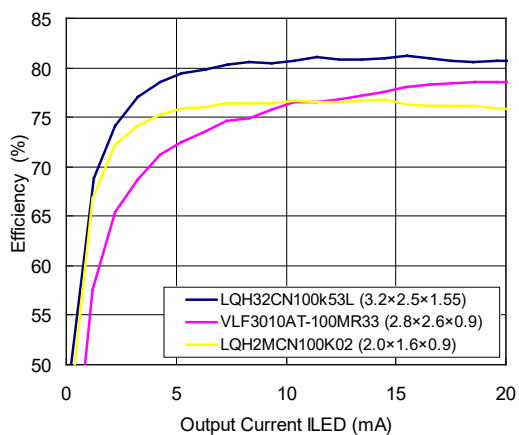

Typical Applications with Using 5.5V or Greater

5LED, $V_{IN(IC)}=3.6V$

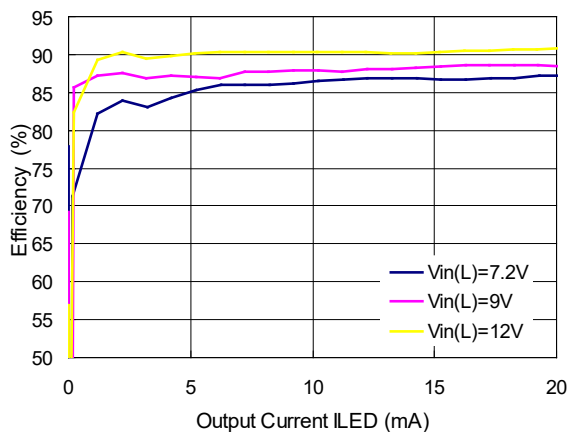

6LED, $V_{IN(IC)}=3.6V$

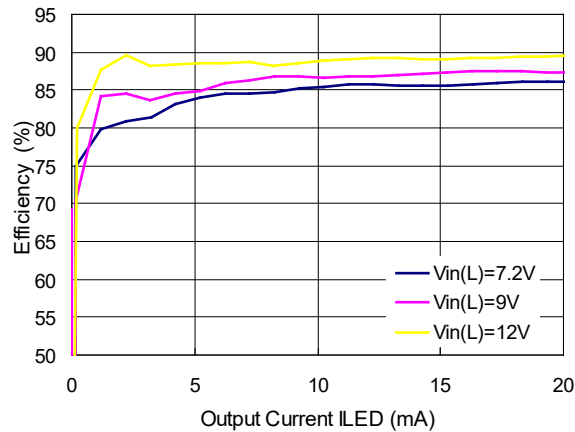

3) Output Voltage vs. Output Current (R1205N823A)

$V_{OUT}=10V$, $L=10\mu H$ (LQH32CN100K53)

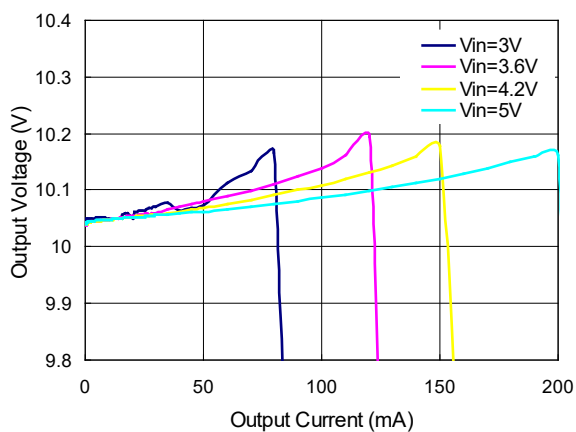

$V_{OUT}=10V$, $L=22\mu H$ (LQH32CN220K53)

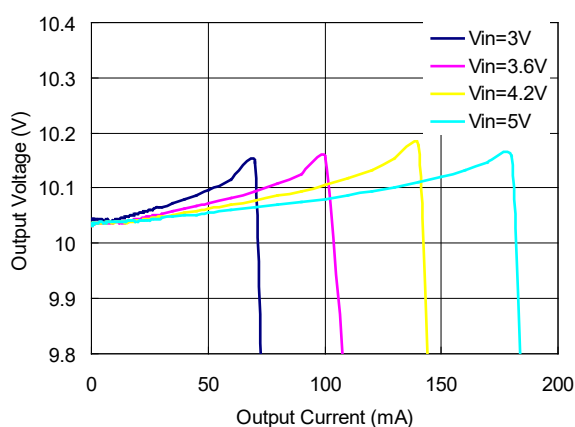

$V_{OUT}=15V$, $L=10\mu H$ (LQH32CN100K53)

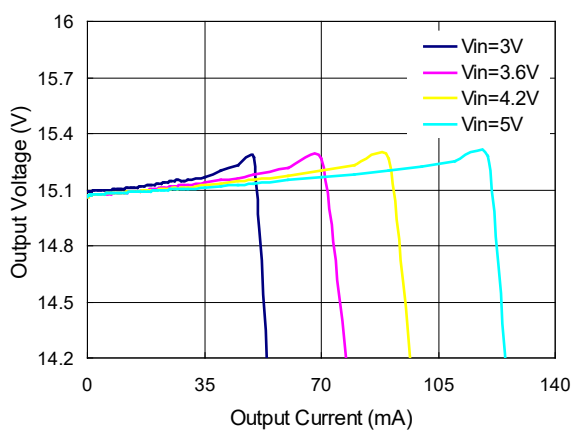

$V_{OUT}=15V$, $L=22\mu H$ (LQH32CN220K53)

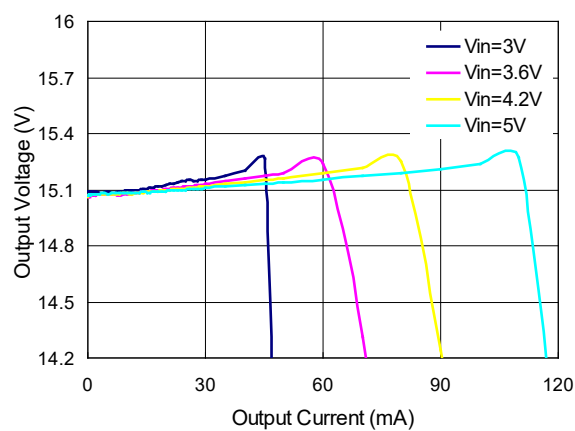

V_{OUT}=20V, L=10μH (LQH32CN100K53)

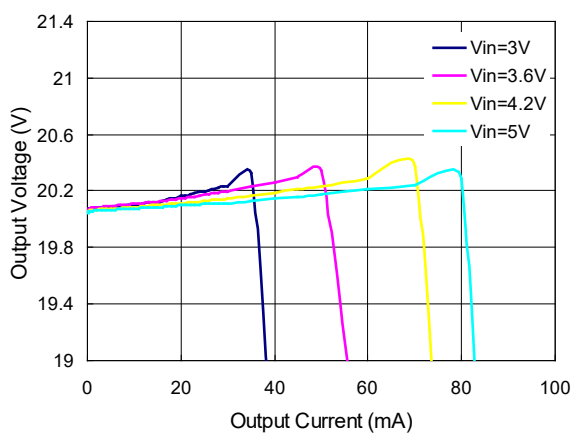

V_{OUT}=20V, L=22μH (LQH32CN220K53)

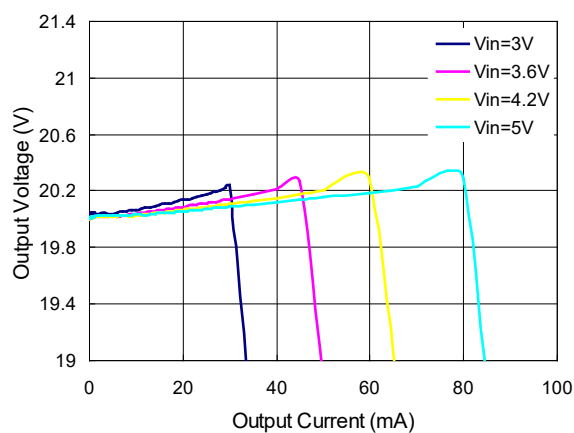

V_{OUT}=20V, V_{IN}=3.6V

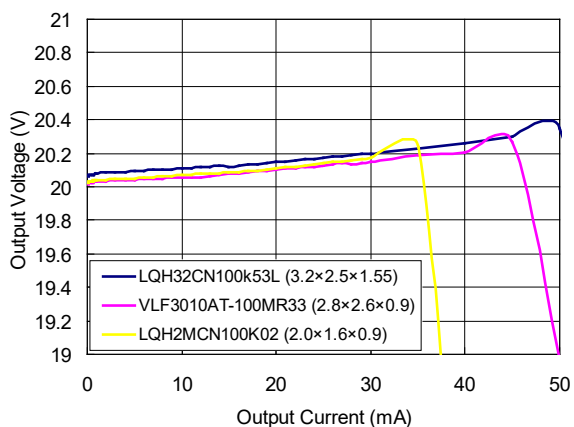

Typical Applications with Using 5.5V or Greater

V_{OUT}=15V, L=10μH (LQH32CN100K53)

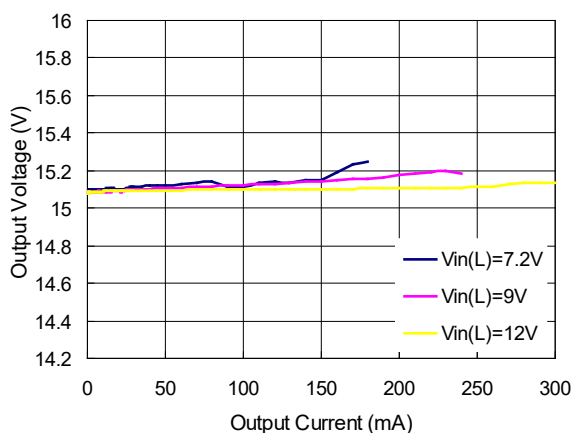

V_{OUT}=20V, L=10μH (LQH32CN100K53)

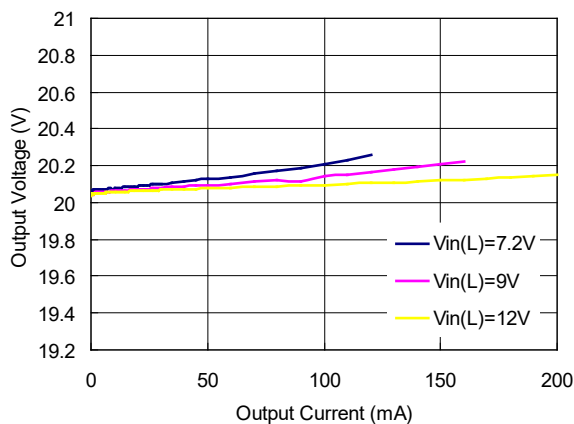

4) Duty vs. ILED

R1205N823B/C

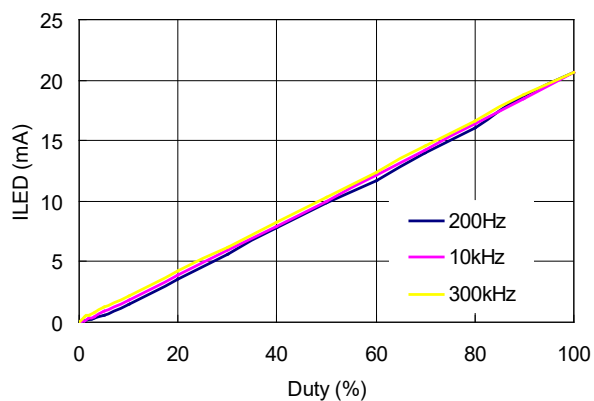

5) OVP Output Waveform

R1205N823B/C

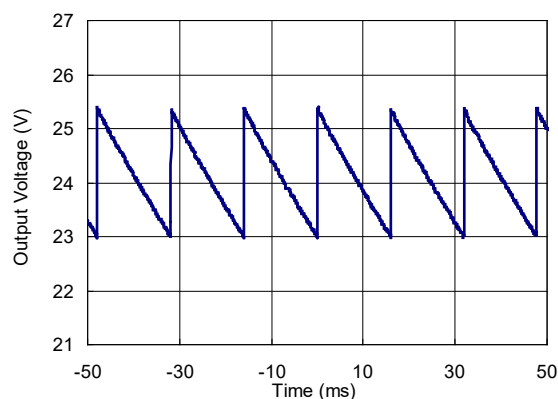

6) Waveform (6LED)

R1205N823B/C (CE Freq=200Hz)

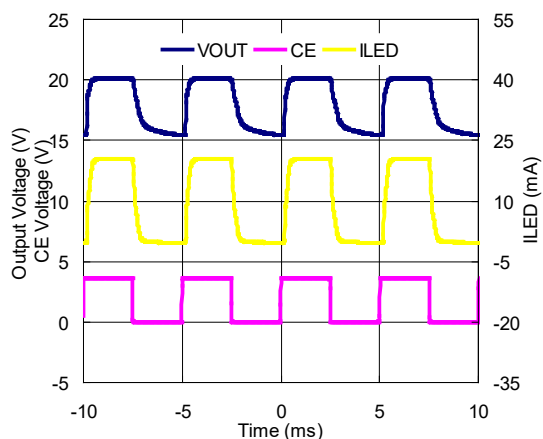

R1205N823B/C (CE Freq=10KHz)

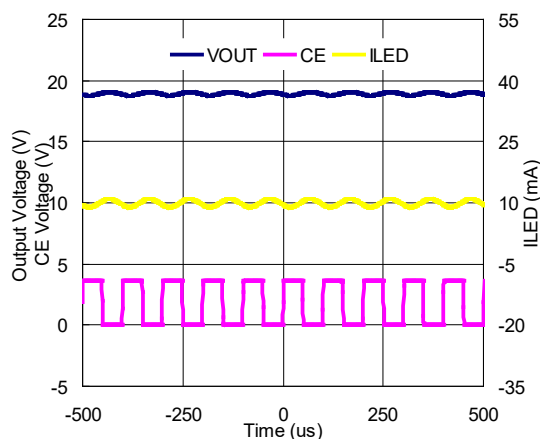

R1205N823B/C (CE Freq=300KHz)

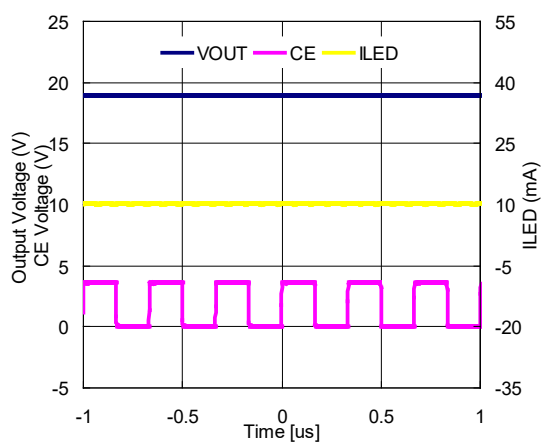

7) Diode Forward Voltage vs. Temperature

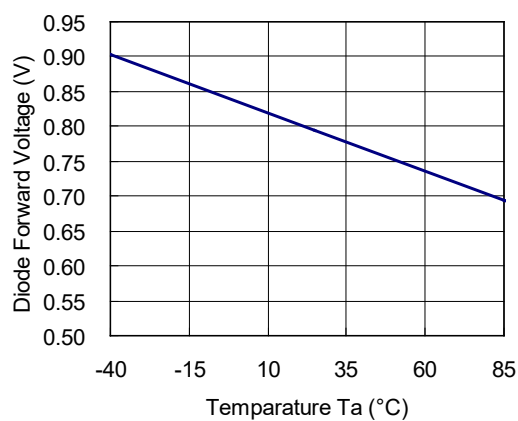

8) Standby Current vs. Temperature

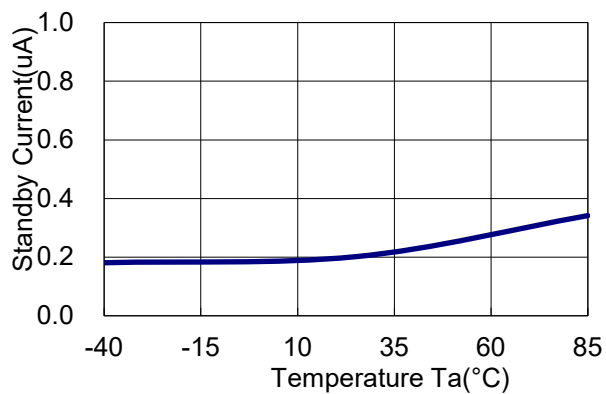

9) Supply Current vs. Temperature

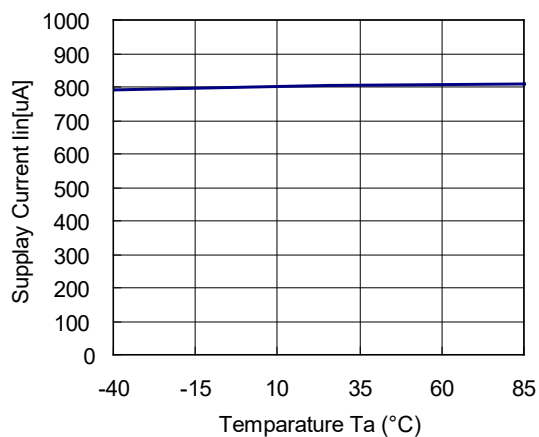

10) UVLO Output Voltage vs. Temperature

R1205x8xxA

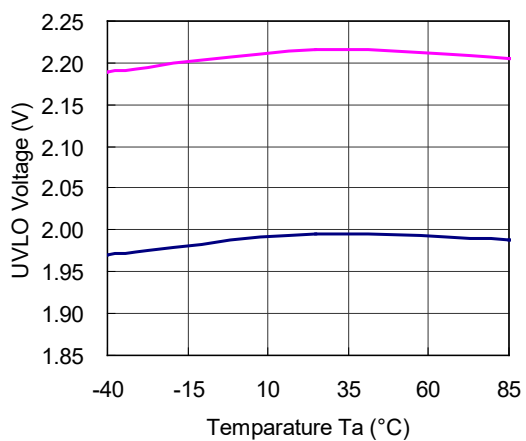

R1205x8xxB/C

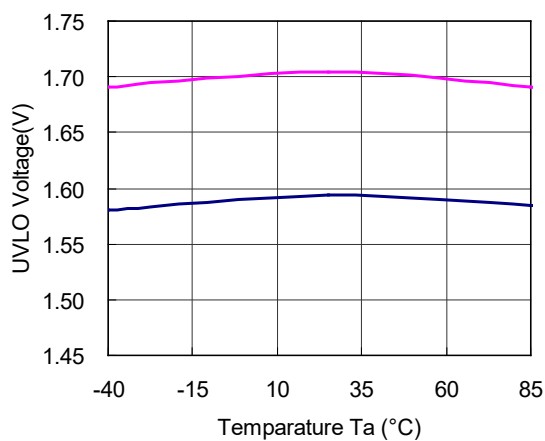

11) VFB Voltage vs. Temperature

R1205x8xxA

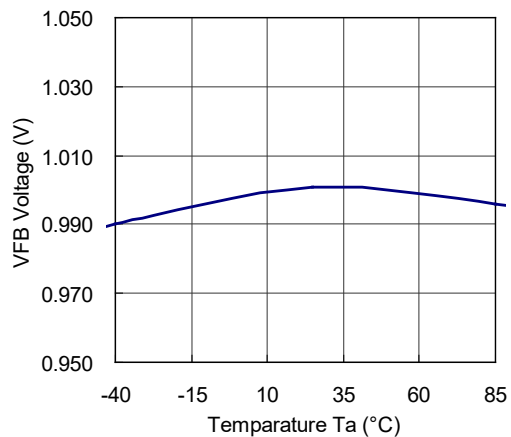

R1205x8xxB

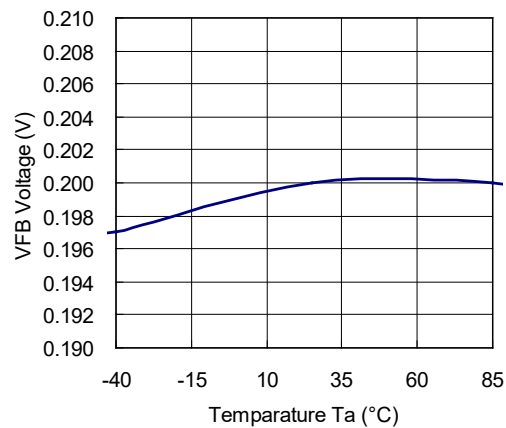

R1205x8xxC

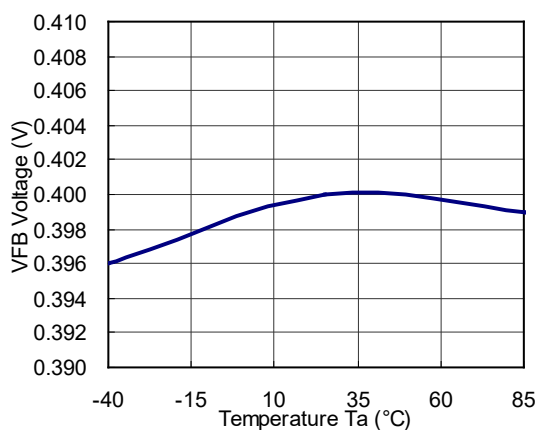

12) Switch ON Resistance RON vs. Temperature

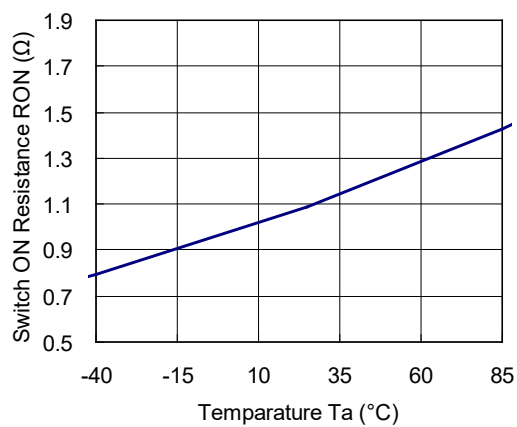

13) OVP Voltage vs. Temperature

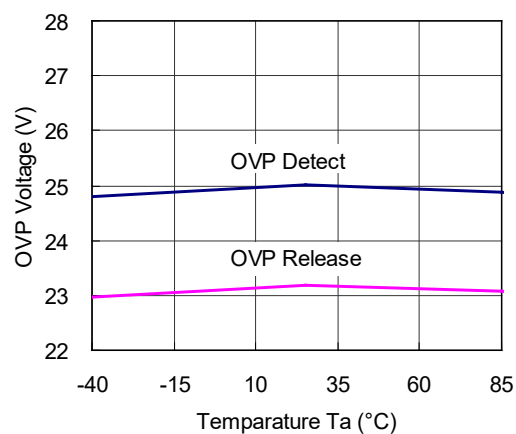

14) LX Current Limit vs. Temperature

R1205x81xx

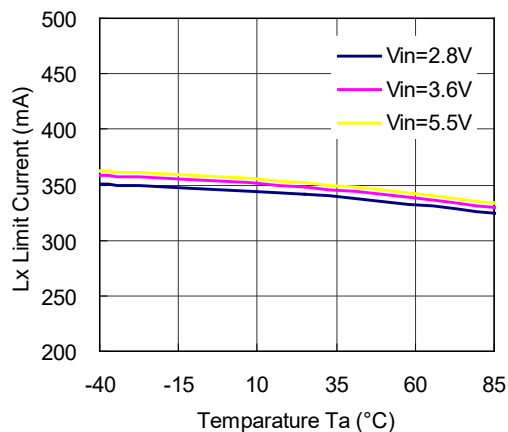

R1205x82xx

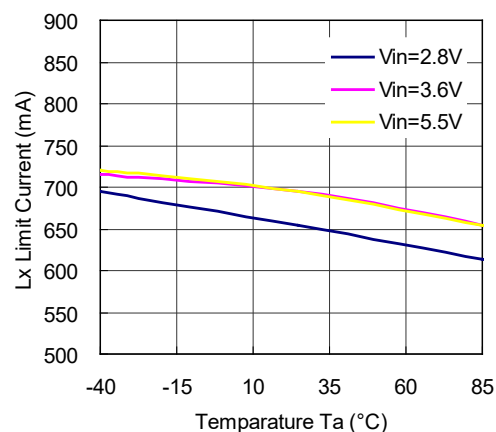

15) Oscillator Frequency vs. Temperature

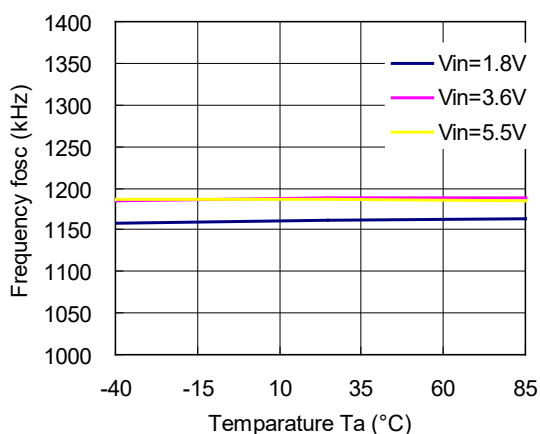

16) Maxduty vs. Temperature

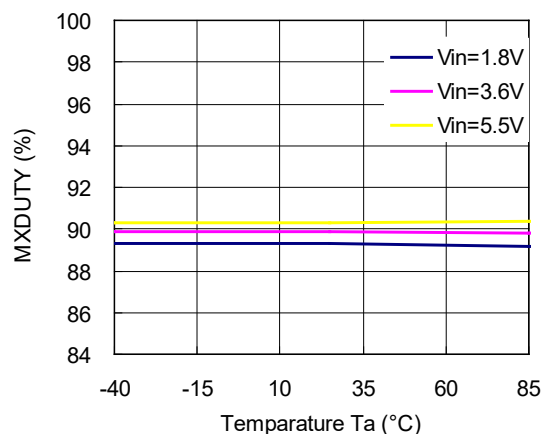

17) Thermal Shutdown Detect / Release Temperature vs. Input Voltage

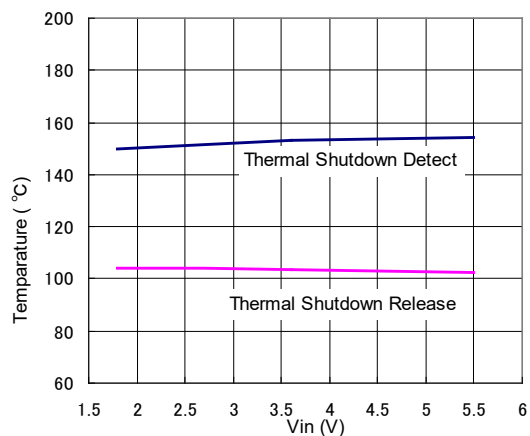

18) Load Transient Response

$V_{IN} = 3.6\text{ V}$, $V_{OUT} = 15\text{ V}$ $I_{OUT} = 0\text{ mA} \Leftrightarrow 30\text{ mA}$

$L = 10\text{ }\mu\text{H}$ Setting : Table 3-A

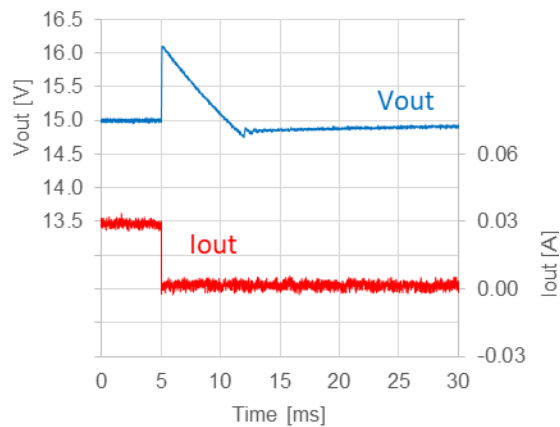
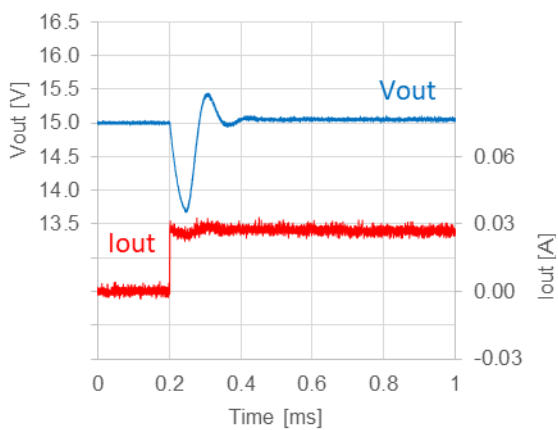

$L = 22\text{ }\mu\text{H}$ Setting : Table 3-A

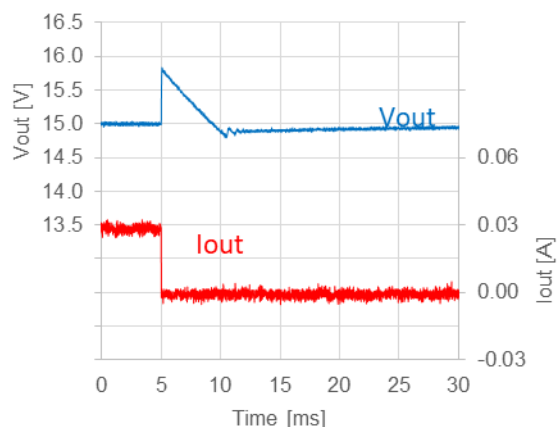
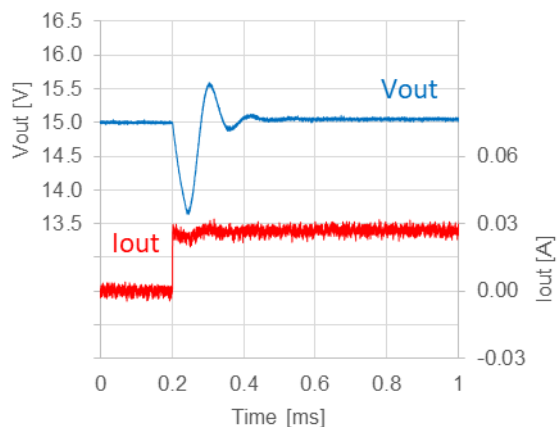

$L = 10\text{ }\mu\text{H}$ Setting : Table 3-B

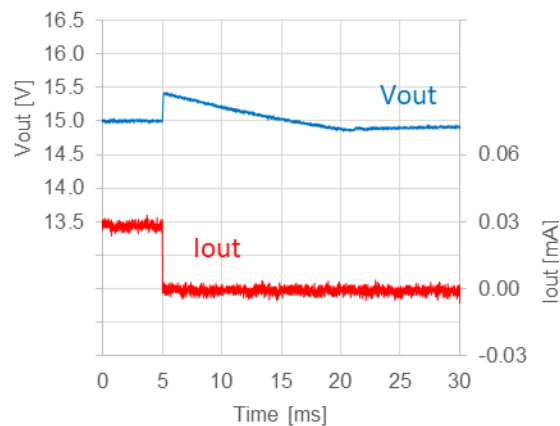
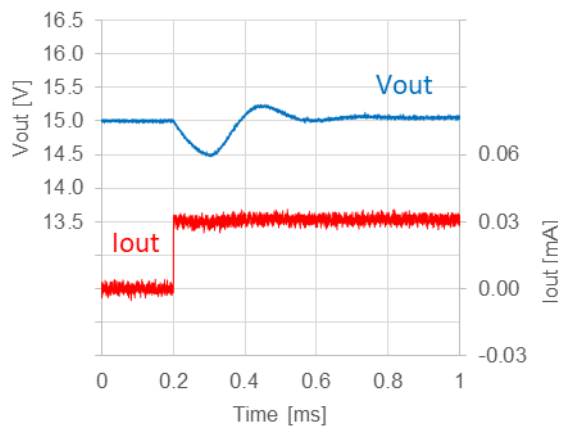

L = 22 μ H Setting : Table 3-B

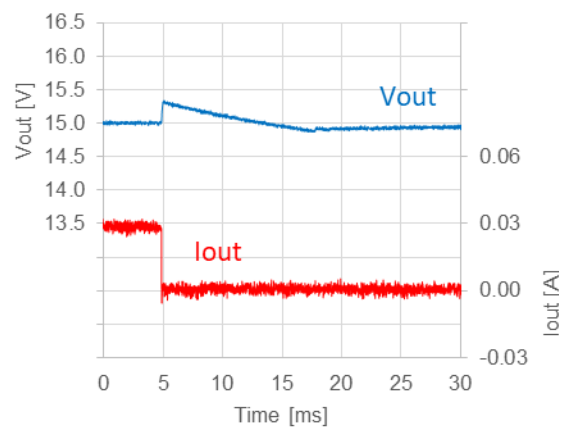
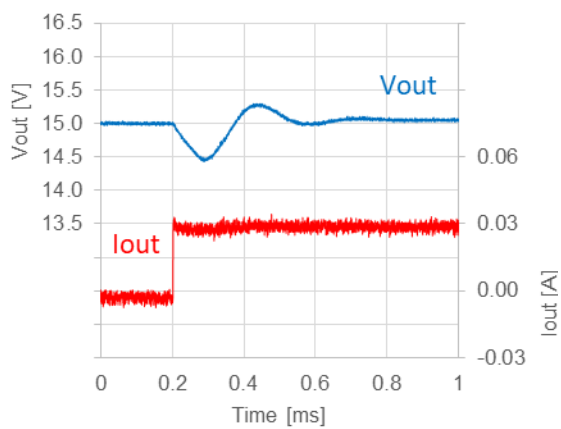

The power dissipation of the package is dependent on PCB material, layout, and environmental conditions. The following measurement conditions are based on JEDEC STD. 51.

Measurement Conditions

Item	Measurement Conditions
Environment	Mounting on Board (Wind Velocity = 0 m/s)
Board Material	Glass Cloth Epoxy Plastic (Four-Layer Board)
Board Dimensions	76.2 mm × 114.3 mm × 0.8 mm
Copper Ratio	Outer Layer (First Layer): Less than 95% of 50 mm Square Inner Layers (Second and Third Layers): Approx. 100% of 50 mm Square Outer Layer (Fourth Layer): Approx. 100% of 50 mm Square
Through-holes	φ 0.2 mm × 25 pcs

Measurement Result

(Ta = 25°C, Tjmax = 125°C)

Item	Measurement Result
Power Dissipation	2400 mW
Thermal Resistance (θja)	θja = 41°C/W
Thermal Characterization Parameter (ψjt)	ψjt = 11°C/W

θja: Junction-to-Ambient Thermal Resistance

ψjt: Junction-to-Top Thermal Characterization Parameter

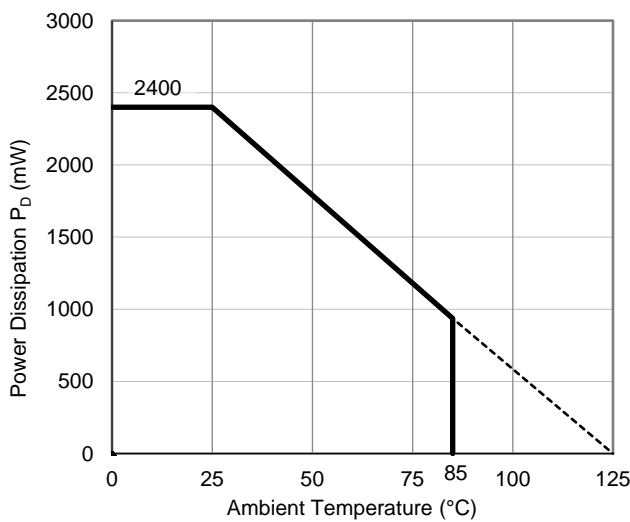

Power Dissipation vs. Ambient Temperature

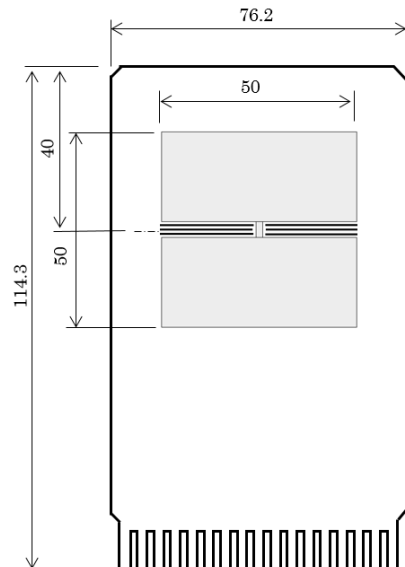

Measurement Board Pattern

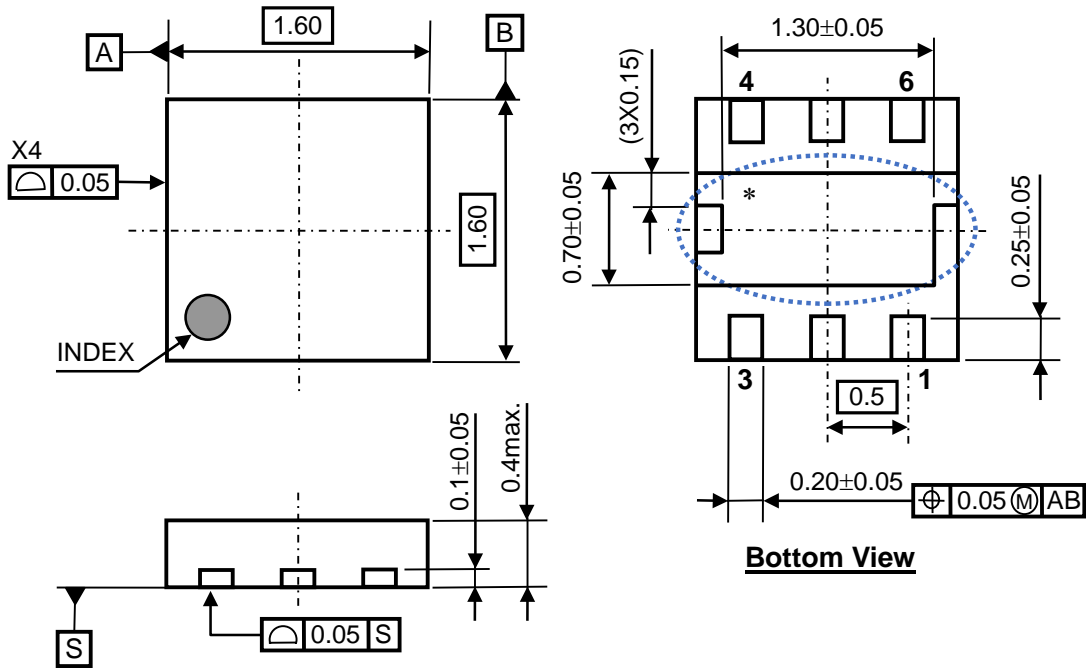

DFN1616-6B Package Dimensions (Unit: mm)

* The tab on the bottom of the package shown by blue circle is a substrate potential (GND). It is recommended that this tab be connected to the ground plane pin on the board but it is possible to leave the tab floating.

The power dissipation of the package is dependent on PCB material, layout, and environmental conditions. The following conditions are used in this measurement.

Measurement Conditions

	Standard Test Land Pattern
Environment	Mounting on Board (Wind Velocity = 0 m/s)
Board Material	Glass Cloth Epoxy Plastic (Double-Sided Board)
Board Dimensions	40 mm × 40 mm × 1.6 mm
Copper Ratio	Top Side: Approx. 50% Bottom Side: Approx. 50%
Through-holes	φ 0.5 mm × 44 pcs

Measurement Result

(Ta = 25°C, Tjmax = 125°C)

	Standard Test Land Pattern
Power Dissipation	460 mW
Thermal Resistance	$\theta_{ja} = (125 - 25^\circ\text{C}) / 0.46 \text{ W} = 217^\circ\text{C/W}$ $\theta_{jc} = 40^\circ\text{C/W}$

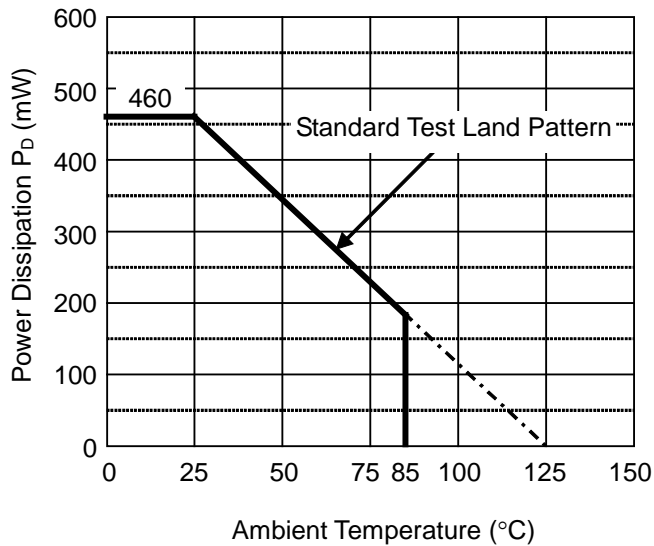

Power Dissipation vs. Ambient Temperature

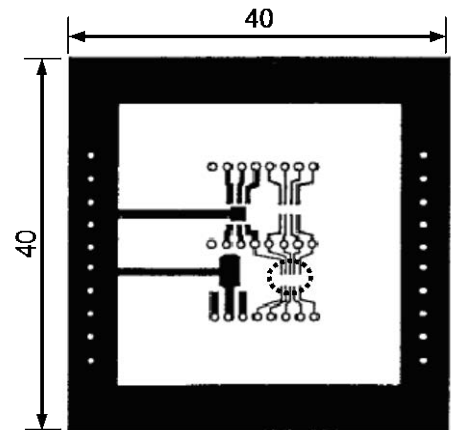

○ IC Mount Area (mm)

Measurement Board Pattern

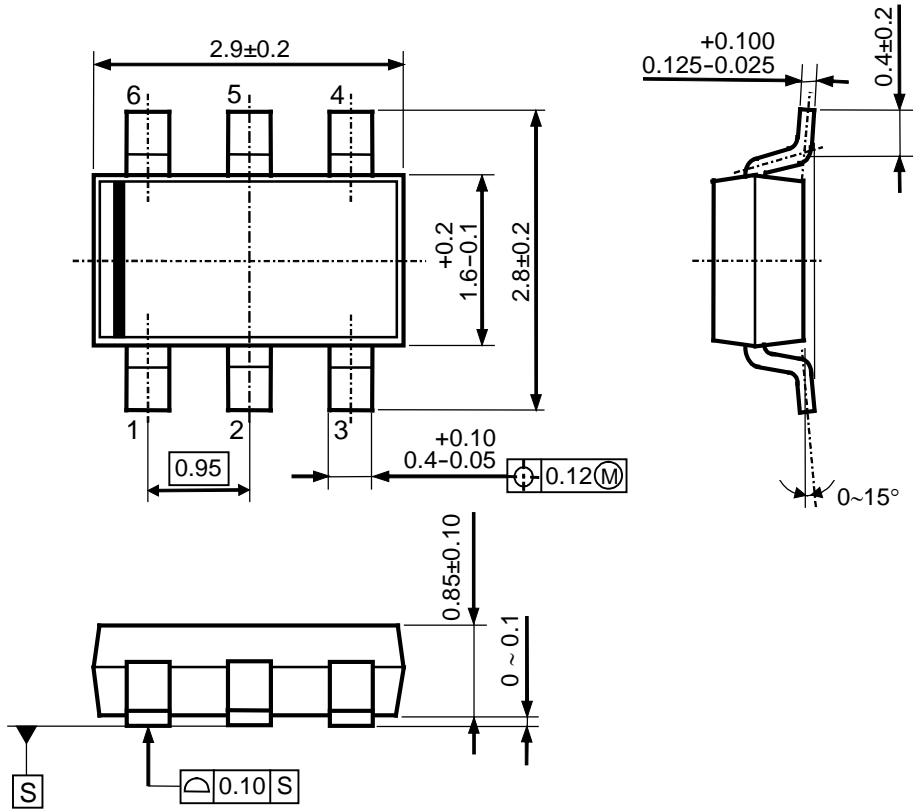

TSOT-23-6 Package Dimensions (Unit: mm)

1. The products and the product specifications described in this document are subject to change or discontinuation of production without notice for reasons such as improvement. Therefore, before deciding to use the products, please refer to our sales representatives for the latest information thereon.
2. The materials in this document may not be copied or otherwise reproduced in whole or in part without the prior written consent of us.
3. This product and any technical information relating thereto are subject to complementary export controls (so-called KNOW controls) under the Foreign Exchange and Foreign Trade Law, and related politics ministerial ordinance of the law. (Note that the complementary export controls are inapplicable to any application-specific products, except rockets and pilotless aircraft, that are insusceptible to design or program changes.) Accordingly, when exporting or carrying abroad this product, follow the Foreign Exchange and Foreign Trade Control Law and its related regulations with respect to the complementary export controls.
4. The technical information described in this document shows typical characteristics and example application circuits for the products. The release of such information is not to be construed as a warranty of or a grant of license under our or any third party's intellectual property rights or any other rights.
5. The products listed in this document are intended and designed for use as general electronic components in standard applications (office equipment, telecommunication equipment, measuring instruments, consumer electronic products, amusement equipment etc.). Those customers intending to use a product in an application requiring extreme quality and reliability, for example, in a highly specific application where the failure or misoperation of the product could result in human injury or death should first contact us.
 - Aerospace Equipment
 - Equipment Used in the Deep Sea
 - Power Generator Control Equipment (nuclear, steam, hydraulic, etc.)
 - Life Maintenance Medical Equipment
 - Fire Alarms / Intruder Detectors
 - Vehicle Control Equipment (automotive, airplane, railroad, ship, etc.)
 - Various Safety Devices
 - Traffic control system
 - Combustion equipment

In case your company desires to use this product for any applications other than general electronic equipment mentioned above, make sure to contact our company in advance. Note that the important requirements mentioned in this section are not applicable to cases where operation requirements such as application conditions are confirmed by our company in writing after consultation with your company.

6. We are making our continuous effort to improve the quality and reliability of our products, but semiconductor products are likely to fail with certain probability. In order to prevent any injury to persons or damages to property resulting from such failure, customers should be careful enough to incorporate safety measures in their design, such as redundancy feature, fire containment feature and fail-safe feature. We do not assume any liability or responsibility for any loss or damage arising from misuse or inappropriate use of the products.
7. The products have been designed and tested to function within controlled environmental conditions. Do not use products under conditions that deviate from methods or applications specified in this datasheet. Failure to employ the products in the proper applications can lead to deterioration, destruction or failure of the products. We shall not be responsible for any bodily injury, fires or accident, property damage or any consequential damages resulting from misuse or misapplication of the products.
8. **Quality Warranty**
 - 8-1. **Quality Warranty Period**

In the case of a product purchased through an authorized distributor or directly from us, the warranty period for this product shall be one (1) year after delivery to your company. For defective products that occurred during this period, we will take the quality warranty measures described in section 8-2. However, if there is an agreement on the warranty period in the basic transaction agreement, quality assurance agreement, delivery specifications, etc., it shall be followed.
 - 8-2. **Quality Warranty Remedies**

When it has been proved defective due to manufacturing factors as a result of defect analysis by us, we will either deliver a substitute for the defective product or refund the purchase price of the defective product.
Note that such delivery or refund is sole and exclusive remedies to your company for the defective product.
 - 8-3. **Remedies after Quality Warranty Period**

With respect to any defect of this product found after the quality warranty period, the defect will be analyzed by us. On the basis of the defect analysis results, the scope and amounts of damage shall be determined by mutual agreement of both parties. Then we will deal with upper limit in Section 8-2. This provision is not intended to limit any legal rights of your company.
9. Anti-radiation design is not implemented in the products described in this document.
10. The X-ray exposure can influence functions and characteristics of the products. Confirm the product functions and characteristics in the evaluation stage.
11. WLCSP products should be used in light shielded environments. The light exposure can influence functions and characteristics of the products under operation or storage.
12. Warning for handling Gallium and Arsenic (GaAs) products (Applying to GaAs MMIC, Photo Reflector). These products use Gallium (Ga) and Arsenic (As) which are specified as poisonous chemicals by law. For the prevention of a hazard, do not burn, destroy, or process chemically to make them as gas or power. When the product is disposed of, please follow the related regulation and do not mix this with general industrial waste or household waste.
13. Please contact our sales representatives should you have any questions or comments concerning the products or the technical information.



Nisshinbo Micro Devices Inc.

Official website

<https://www.nisshinbo-microdevices.co.jp/en/>

Purchase information

<https://www.nisshinbo-microdevices.co.jp/en/buy/>

Mouser Electronics

Authorized Distributor

Click to View Pricing, Inventory, Delivery & Lifecycle Information:

[Nisshinbo Micro Devices:](#)

[R1205L821A-TR](#) [R1205L821B-TR](#) [R1205L811C-TR](#) [R1205N813A-TR-FE](#) [R1205L811A-TR](#) [R1205L811B-TR](#)
[R1205L821C-TR](#) [R1205N813B-TR-FE](#) [R1205N823A-TR-FE](#) [R1205N823B-TR-FE](#)