

# DSC-W80/W85

## SERVICE MANUAL

**LEVEL 3**

**Ver. 1.0 2007.03**

Revision History

How to use  
Acrobat Reader

Internal memory  
**ON BOARD**



Photo: Silver

US Model  
Canadian Model  
AEP Model  
UK Model  
E Model  
Australian Model  
Hong Kong Model  
Chinese Model  
Korea Model  
Argentine Model  
Brazilian Model  
Japanese Model  
Tourist Model

### Link

• SERVICE NOTE

• SCHEMATIC DIAGRAMS

• REPAIR PARTS LIST

• MODEL INFORMATION TABLE

• PRINTED WIRING BOARDS

The components identified by mark  $\Delta$  or dotted line with mark  $\Delta$  are critical for safety. Replace only with part number specified.

Les composants identifiés par une marque  $\Delta$  sont critiques pour la sécurité. Ne les remplacer que par une pièce portant le numéro spécifié.

DIGITAL STILL CAMERA

**SONY**<sup>®</sup>

## Model information table

Model	DSC-W80/Silver	DSC-W80/Black	DSC-W80/White	DSC-W80/Pink	DSC-W85/Silver
Destination	US, CND, AEP, UK, E, AUS, HK, CH, KR, AR, BR, J, JE	US, CND, AEP, UK, E, AUS, HK, CH, KR, JE	US, CND, AEP, UK, E, AUS, HK, CH, KR, J, JE	US, CND, AEP, UK, E, AUS, HK, CH, KR, J, JE	CND, AEP, UK, E, AUS, KR

- Abbreviation

- AR : Argentine model
- AUS : Australian model
- BR : Brazilian model
- CH : Chinese model
- CND: Canadian model
- EE : East European model
- HK : Hong Kong model
- J : Japanese model
- JE : Tourist model
- KR : Korea model
- NE : North European model

**CAUTION**

Danger of explosion if battery is incorrectly replaced.  
Replace only with the same or equivalent type.

### SAFETY-RELATED COMPONENT WARNING!!

**COMPONENTS IDENTIFIED BY MARK  $\triangle$  OR DOTTED LINE WITH MARK  $\triangle$  ON THE SCHEMATIC DIAGRAMS AND IN THE PARTS LIST ARE CRITICAL TO SAFE OPERATION. REPLACE THESE COMPONENTS WITH SONY PARTS WHOSE PART NUMBERS APPEAR AS SHOWN IN THIS MANUAL OR IN SUPPLEMENTS PUBLISHED BY SONY.**

### ATTENTION AU COMPOSANT AYANT RAPPORT À LA SÉCURITÉ!

**LES COMPOSANTS IDENTIFIÉS PAR UNE MARQUE  $\triangle$  SUR LES DIAGRAMMES SCHÉMATIQUES ET LA LISTE DES PIÈCES SONT CRITIQUES POUR LA SÉCURITÉ DE FONCTIONNEMENT. NE REMPLACER CES COMPOSANTS QUE PAR DES PIÈCES SONY DONT LES NUMÉROS SONT DONNÉS DANS CE MANUEL OU DANS LES SUPPLÉMENTS PUBLIÉS PAR SONY.**

## SAFETY CHECK-OUT

After correcting the original service problem, perform the following safety checks before releasing the set to the customer.

1. Check the area of your repair for unsoldered or poorly-soldered connections. Check the entire board surface for solder splashes and bridges.
2. Check the interboard wiring to ensure that no wires are "pinched" or contact high-wattage resistors.
3. Look for unauthorized replacement parts, particularly transistors, that were installed during a previous repair. Point them out to the customer and recommend their replacement.
4. Look for parts which, through functioning, show obvious signs of deterioration. Point them out to the customer and recommend their replacement.
5. Check the B+ voltage to see it is at the values specified.
6. FLEXIBLE Circuit Board Repairing
  - Keep the temperature of the soldering iron around 270°C during repairing.
  - Do not touch the soldering iron on the same conductor of the circuit board (within 3 times).
  - Be careful not to apply force on the conductor when soldering or unsoldering.

### Unleaded solder

Boards requiring use of unleaded solder are printed with the lead-free mark (LF) indicating the solder contains no lead. (Caution: Some printed circuit boards may not come printed with the lead free mark due to their particular size.)



### : LEAD FREE MARK

Unleaded solder has the following characteristics.

- Unleaded solder melts at a temperature about 40°C higher than ordinary solder.  
Ordinary soldering irons can be used but the iron tip has to be applied to the solder joint for a slightly longer time.  
Soldering irons using a temperature regulator should be set to about 350°C.  
Caution: The printed pattern (copper foil) may peel away if the heated tip is applied for too long, so be careful!
- Strong viscosity  
Unleaded solder is more viscous (sticky, less prone to flow) than ordinary solder so use caution not to let solder bridges occur such as on IC pins, etc.
- Usable with ordinary solder  
It is best to use only unleaded solder but unleaded solder may also be added to ordinary solder.

## TABLE OF CONTENTS

<i>Section</i>	<i>Title</i>	<i>Page</i>
<b>1. SERVICE NOTE</b>		
1-4.	Method for Copying or Erasing the Data in Internal Memory .....	1-1
1-5.	How to Write Data to Internal Memory .....	1-2
<b>4. PRINTED WIRING BOARDS AND SCHEMATIC DIAGRAMS</b>		
4-2.	Schematic Diagrams .....	4-3
4-3.	Printed Wiring Boards .....	4-21
4-4.	Mounted Parts Location .....	4-29
<b>5. REPAIR PARTS LIST</b>		
5-2.	Electrical Parts List .....	5-6

## 1-4. METHOD FOR COPYING OR ERASING THE DATA IN INTERNAL MEMORY

The data can be copied/erased by the operations on the HOME screen. (When erasing the data, execute formatting the internal memory.)

**Note 1:** When replacing the SY-173 board, erase the data in internal memory of the board before replacement.

**Note 2:** When replacing the SY-173 board, execute formatting and initialize the internal memory after replacement.

### Method for Copying the Data in Internal Memory

#### Copy

Copies all images in the internal memory to a "Memory Stick Duo".

- ① Insert a "Memory Stick Duo" having 32 MB or larger capacity.
- ② Select [Copy] with ▲/▼/◀/▶ on the control button, then press ●.  
The message "All data in internal memory will be copied" appears.
- ③ Select [OK] with ▲, then press ●.  
Copying starts.

#### To cancel the copying

Select [Cancel] in step ③, then press ●.

- Use a fully charged battery pack. If you attempt to copy image files using a battery pack with little remaining charge, the battery pack may run out, causing copying to fail or possibly corrupting the data.
- You cannot copy individual images.
- The original images in the internal memory are retained even after copying. To delete the contents of the internal memory, remove the "Memory Stick Duo" after copying, then execute the [Format] command in [Internal Memory Tool].
- When you copy the data in the internal memory to the "Memory Stick Duo", all the data will be copied. You cannot choose a specific folder on the "Memory Stick Duo" as the destination for the data to be copied.
- Even if you copy data, a **DPOF** (Print order) mark is not copied

### Method for Formatting the Internal Memory

This item does not appear when a "Memory Stick Duo" is inserted in the camera.

#### Format

Formats the internal memory.

- Note that formatting irrevocably erases all data in the internal memory, including even protected images.

- ① Select [Format] with ▲/▼/◀/▶ on the control button, then press ●.  
The message "All data in internal memory will be erased" appears.
- ② Select [OK] with ▲, then press ●.  
The format is completed.

#### To cancel the formatting

Select [Cancel] in step ②, then press ●.

## 1-5. HOW TO WRITE DATA TO INTERNAL MEMORY

Usually, the camera has been set so as to disable the data writing from the PC to the internal memory of the camera. This setting must be changed temporarily when the data is to be written to the internal memory such as a case after the board replacement. To change the setting, use the write enable tool “WriteEnableTool.exe”.

### Data writing method

- 1) Connect the PC to the camera (USB mode: Mass Storage), and switch the driver to the “Sony Seus USB Driver”.
- 2) Start the Write Enable Tool and the SeusEX.
- 3) Click the Activate Write Enable Mode button of the Write Enable Tool.

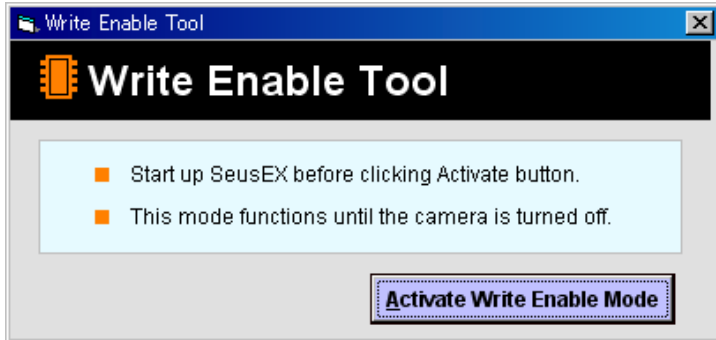

- 4) Upon completion of the setting change, the following message will be displayed.

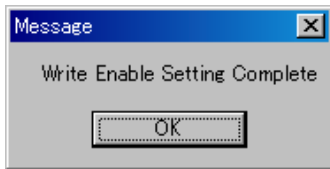

- 5) Return the driver to the original one, and connect the PC to the camera (USB mode: Mass Storage).
- 6) Write the data read out into the PC to the internal memory of the camera.
- 7) Disconnect the PC from the camera, and turn off the camera.

**Note:** By turning off the camera, the write enable setting is reset.

## 1-4. 内蔵メモリのデータコピーおよび消去方法

内蔵メモリのデータコピーまたは消去はホーム画面の操作から実行可能です。（消去する場合は内蔵メモリの初期化を行います。）

**Note1**：SY-173基板交換の際は、基板交換前に内蔵メモリのデータを消去して下さい。

**Note2**：SY-173基板交換の際は、基板交換後に内蔵メモリのフォーマットおよび初期化を実行して下さい。

### 内蔵メモリのコピー方法

#### コピー

内蔵メモリーに記録した画像を、“メモリースティック デュオ”に一括コピーします。

- ① 32MB以上の容量のある“メモリースティック デュオ”を本体に入れる。
- ② コントロールボタンの▲/▼/◀/▶で[コピー]を選び、中央の●を押す。  
「内蔵メモリーのデータがすべてコピーされます」というメッセージが表示される。
- ③ ▲で[実行]を選び、中央の●を押す。  
コピーが実行される。

#### コピーを中止するには

手順③で、[キャンセル]を選び、中央の●を押す。

十分に充電したバッテリーをご使用ください。残量の少ないバッテリーを使用して画像ファイルのコピーすると、バッテリー切れのためデータを転送できなったり、データを破損するおそれがあります。

画像ごとのコピーはできません。

データをコピーしても、内蔵メモリー内のデータは削除されません。内蔵メモリーの内容を消去するには、コピー後に“メモリースティック デュオ”を本体から取りはずし、[内蔵メモリーツール]の[フォーマット]を行ってください。

データをコピーすると“メモリースティック デュオ”内に新しいフォルダが作成されます。コピー先のフォルダを指定することはできません。

データのコピーを行っても、DPOF(プリント予約)マークの設定はコピーされません。

### 内蔵メモリのフォーマット方法

“メモリースティック デュオ”が本機に入っている場合は表示されません。

#### フォーマット

内蔵メモリーの管理領域をフォーマット(初期化)します。

フォーマットすると、プロテクトしてある画像も含めて、すべてのデータが消去され、元に戻せません。

- ① コントロールボタンの▲/▼/◀/▶で[フォーマット]を選び、中央の●を押す。  
「内蔵メモリーのデータがすべて消去されます」というメッセージが表示される。
- ② ▲で[実行]を選び、中央の●を押す。  
フォーマットが実行される。

#### フォーマットを中止するには

手順②で、[キャンセル]を選び、中央の●を押す。

## 1-5. 内蔵メモリヘータを書き戻す方法

通常は、PCからカメラの内蔵メモリヘータを書き込むことはできない設定になっています。

基板交換後などに、内蔵メモリヘータを書き戻す場合には、この設定を一時的に変更する必要があります。

設定の変更には、書き込み許可ツール（WriteEnableTool.exe）を使用します。

### 書き戻し方法

- 1) カメラとPCをマスタストレージ接続し、ドライバを“Sony Seus USB Driver”に切り替える。
- 2) 書き込み許可ツールとSeusEXを起動する。
- 3) 書き込み許可ツールの[Activate Write Enable Mode]ボタンをクリックする。

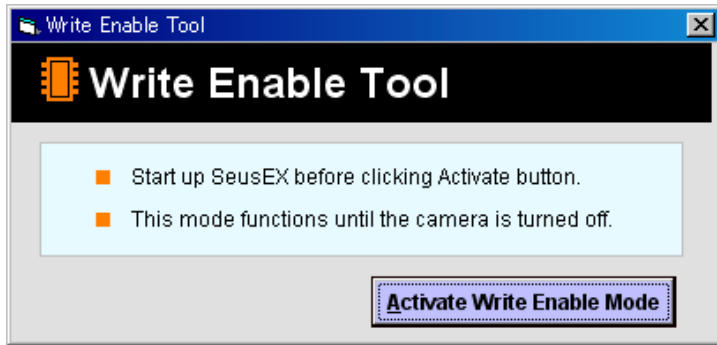

- 4) 設定の変更が終了すると、次のメッセージが表示されます。

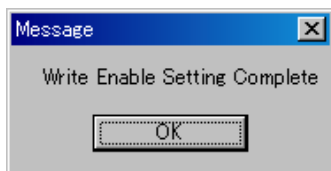

- 5) ドライバを元に戻して、カメラとPCをマスタストレージ接続する。
- 6) PCに読み出しておいたデータをカメラの内蔵メモリに書き込む。
- 7) カメラとPCの接続を解除し、カメラの電源をOFFにする。

注意：カメラの電源をOFFにすることにより、書き込み許可の設定が解除されます。

## 4-2. SCHEMATIC DIAGRAMS

### Link

<ul style="list-style-type: none"><li>• CD-701 FLEXIBLE BOARD (CCD IMAGER)</li></ul>	<ul style="list-style-type: none"><li>• SY-173 BOARD (6/10) (CPU (POWER SUPPLY), BATTERY IN, CLOCK)</li></ul>
<ul style="list-style-type: none"><li>• SY-173 BOARD (1/10) (CCD SIGNAL PROCESS)</li></ul>	<ul style="list-style-type: none"><li>• SY-173 BOARD (7/10) (AUDIO, VIDEO)</li></ul>
<ul style="list-style-type: none"><li>• SY-173 BOARD (2/10) (LENS DRIVE)</li></ul>	<ul style="list-style-type: none"><li>• SY-173 BOARD (8/10) (FRONT CONTROL)</li></ul>
<ul style="list-style-type: none"><li>• SY-173 BOARD (3/10) (OIS DRIVE)</li></ul>	<ul style="list-style-type: none"><li>• SY-173 BOARD (9/10) (DC/DC CONVERTER)</li></ul>
<ul style="list-style-type: none"><li>• SY-173 BOARD (4/10) (CPU (SIGNAL PROCESS 1))</li></ul>	<ul style="list-style-type: none"><li>• SY-173 BOARD (10/10) (CONNECTOR)</li></ul>
<ul style="list-style-type: none"><li>• SY-173 BOARD (5/10) (CPU (SIGNAL PROCESS 2))</li></ul>	

- COMMON NOTE FOR SCHEMATIC DIAGRAMS



## 4-2. SCHEMATIC DIAGRAMS

### 4. PRINTED WIRING BOARDS AND SCHEMATIC DIAGRAMS

#### 4-2. SCHEMATIC DIAGRAMS

**THIS NOTE IS COMMON FOR SCHEMATIC DIAGRAMS**  
**(In addition to this, the necessary note is printed in each block)**

**(For schematic diagrams)**

- All capacitors are in  $\mu\text{F}$  unless otherwise noted.  $\text{pF} : \mu$   
 $\mu\text{F}$ . 50 V or less are not indicated except for electrolytics  
and tantalums.
- Chip resistors are 1/10 W unless otherwise noted.  
 $\text{k}\Omega=1000 \Omega$ ,  $\text{M}\Omega=1000 \text{k}\Omega$ .
- Caution when replacing chip parts.  
New parts must be attached after removal of chip.  
Be careful not to heat the minus side of tantalum  
capacitor, Because it is damaged by the heat.
- Some chip part will be indicated as follows.

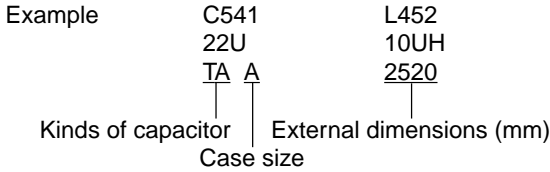

- Constants of resistors, capacitors, ICs and etc with XX  
indicate that they are not used.  
In such cases, the unused circuits may be indicated.
- Parts with ★ differ according to the model/destination.  
Refer to the mount table for each function.
- All variable and adjustable resistors have characteristic  
curve B, unless otherwise noted.
- Signal name  
XEDIT → EDIT      PB/XREC → PB/REC
- : non flammable resistor
- : fusible resistor
- : panel designation
- : B+ Line
- : B- Line
- : IN/OUT direction of (+,-) B LINE.
- : adjustment for repair.
- : not use circuit

**(Measuring conditions voltage and waveform)**

- Voltages and waveforms are measured between the  
measurement points and ground when camera shoots  
color bar chart of pattern box. They are reference values  
and reference waveforms.  
(VOM of DC 10 M $\Omega$  input impedance is used)
- Voltage values change depending upon input  
impedance of VOM used.)

**Precautions for Replacement of Imager**

- If the imager has been replaced, carry out all the adjustments  
for the camera section.
- As the imager may be damaged by static electricity from  
its structure, handle it carefully like for the MOS IC.  
In addition, ensure that the receiver is not covered with  
dusts nor exposed to strong light.

1. Connection

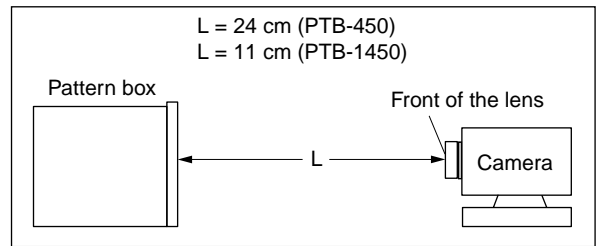
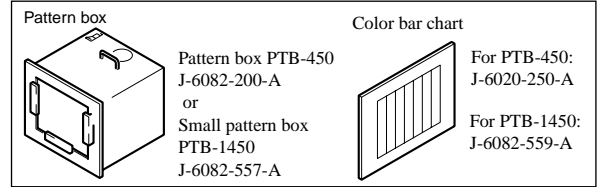

2. Adjust the distance so that the output waveform of Fig. a and the Fig. b can be obtain.

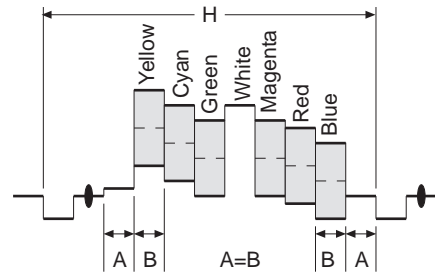

Fig. a (Video output terminal output waveform)

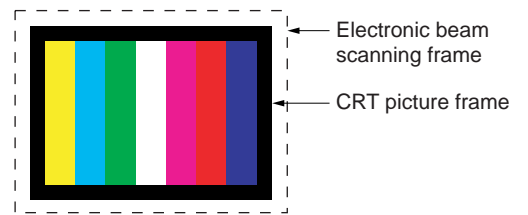

Fig.b (Picture on monitor TV)

When indicating parts by reference number, please include the board name.

The components identified by mark  $\triangle$  or dotted line with mark  $\triangle$  are critical for safety. Replace only with part number specified.

Les composants identifiés par une marque  $\triangle$  sont critiques pour la sécurité. Ne les remplacer que par une pièce portant le numéro spécifié.

A  
B  
C  
D  
E  
F  
G  
H

# CD-701 FLEXIBLE BOARD CCD IMAGER

▲:Voltage measurement of the CSP ICs and the Transistors with ▲ mark, are not possible.

SY-173  
(1/10)  
CN301  
(Page 4-6  
of Level 3)

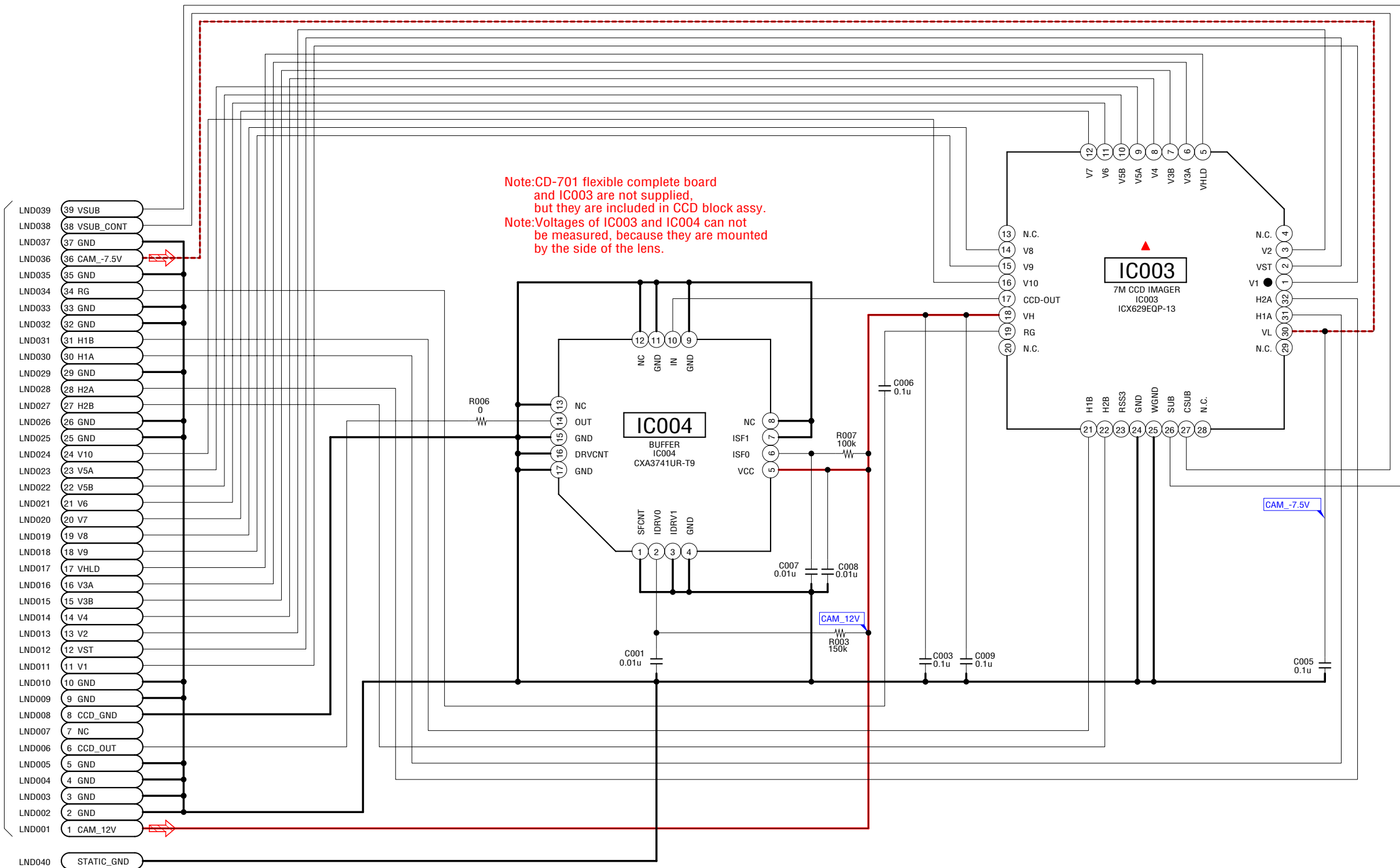

# SY-173 BOARD (1/10)

## CCD SIGNAL PROCESS

XX MARK:NO MOUNT  
NO MARK:REC/PB MODE  
R:REC MODE  
P:PB MODE

▲:Voltage measurement of the CSP ICs and the Transistors with ▲ mark, are not possible.

CD-701 FLEXIBLE LND001-LND039 (Page 4-5 of Level 3)

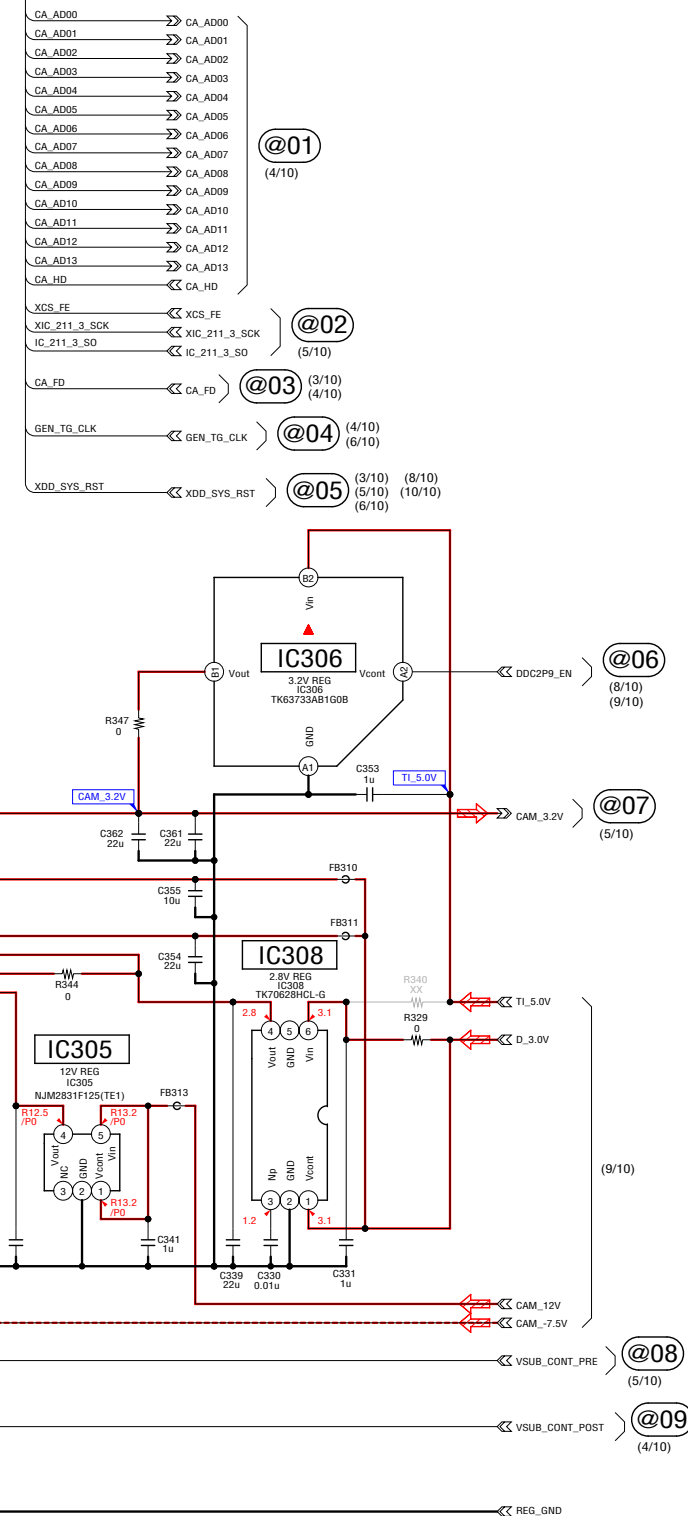
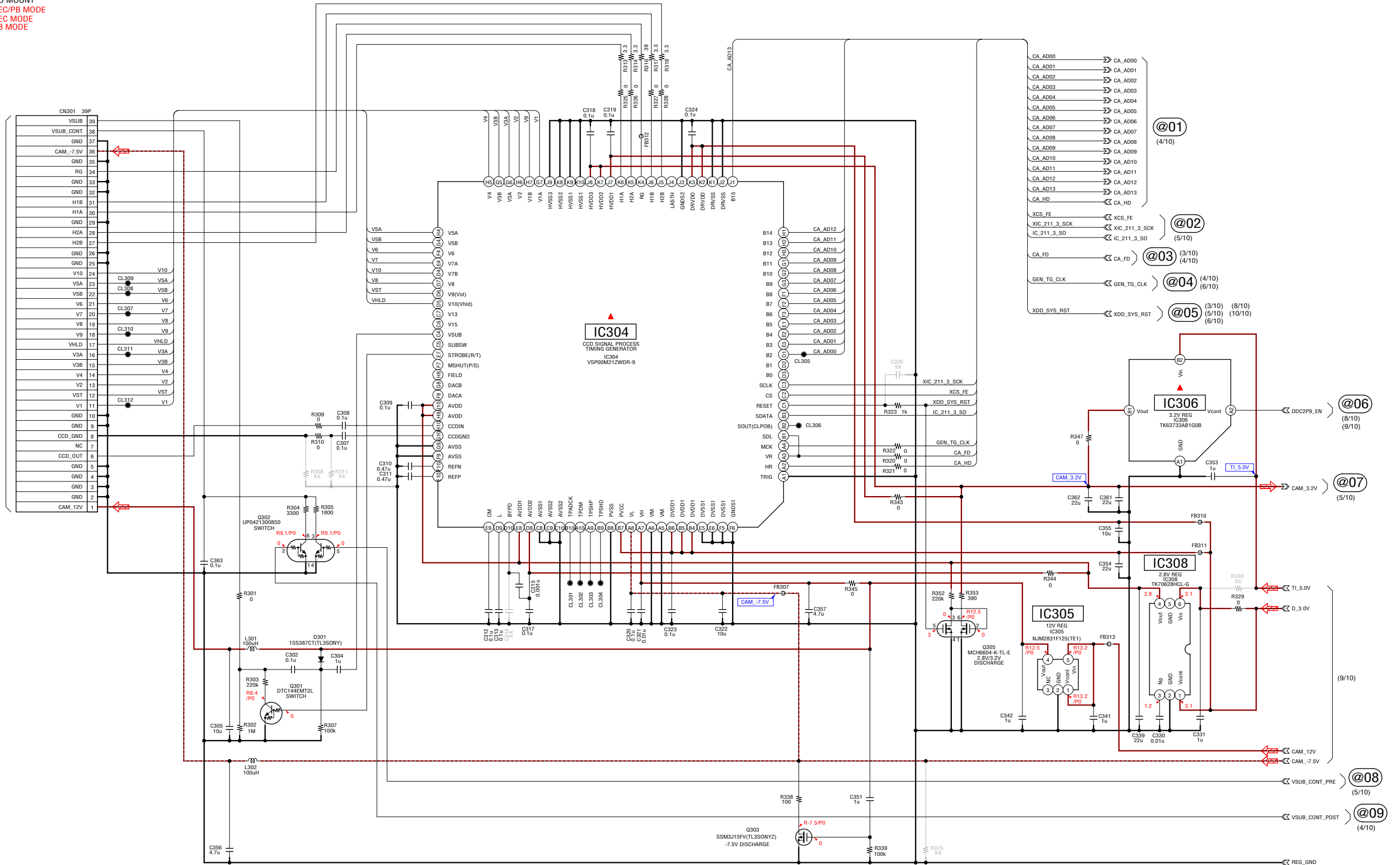

# SY-173 BOARD (2/10)

## LENS DRIVE

XX MARK:NO MOUNT

▲:Voltage measurement of the CSP ICs and the Transistors with ▲ mark, are not possible.

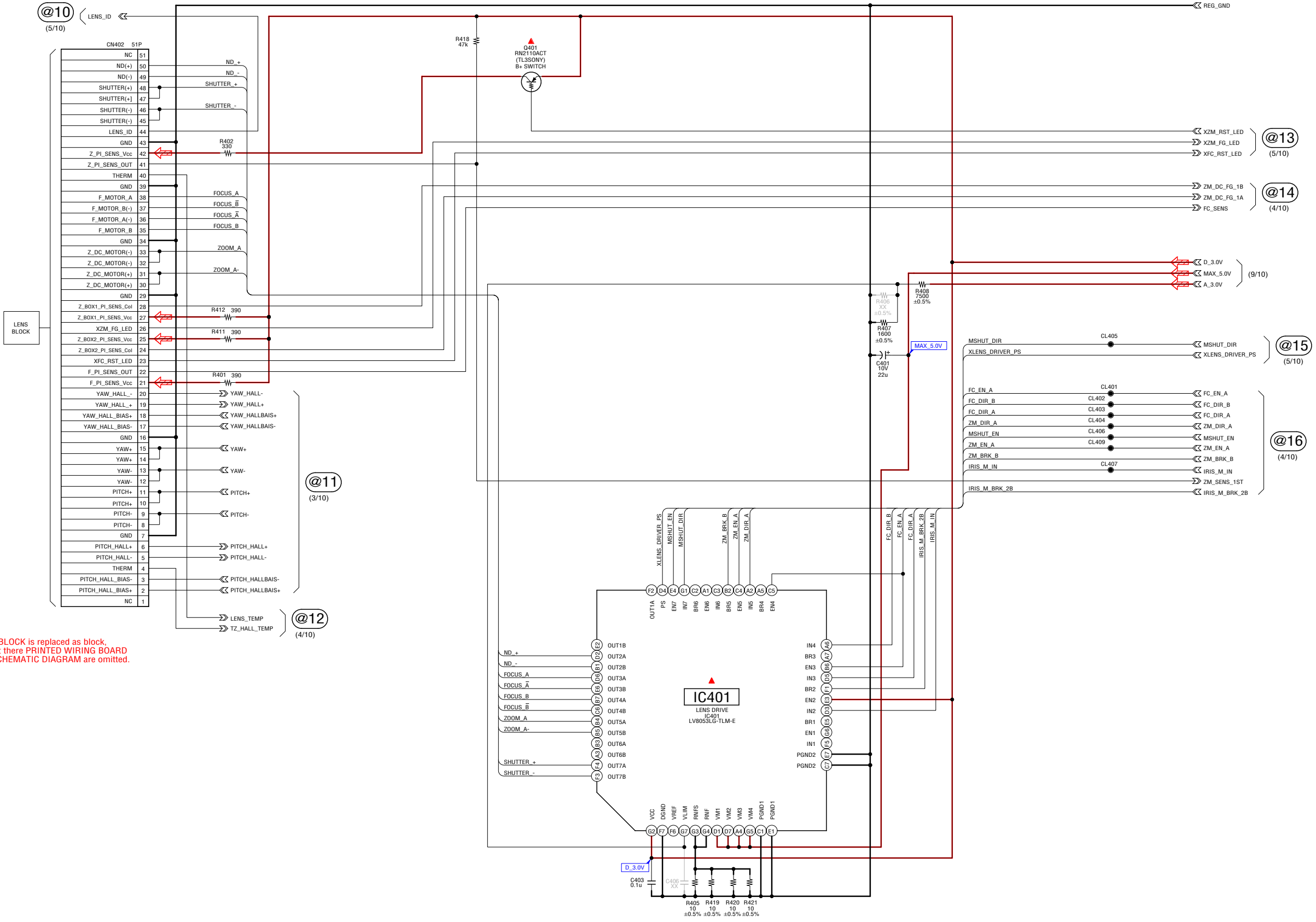

LENS BLOCK is replaced as block, so that there PRINTED WIRING BOARD and SCHEMATIC DIAGRAM are omitted.

# SY-173 BOARD (3/10)

OIS DRIVE  
 XX MARK:NO MOUNT  
 NO MARK:REC/PB MODE

▲:Voltage measurement of the CSP ICs and the Transistors with ▲ mark, are not possible.

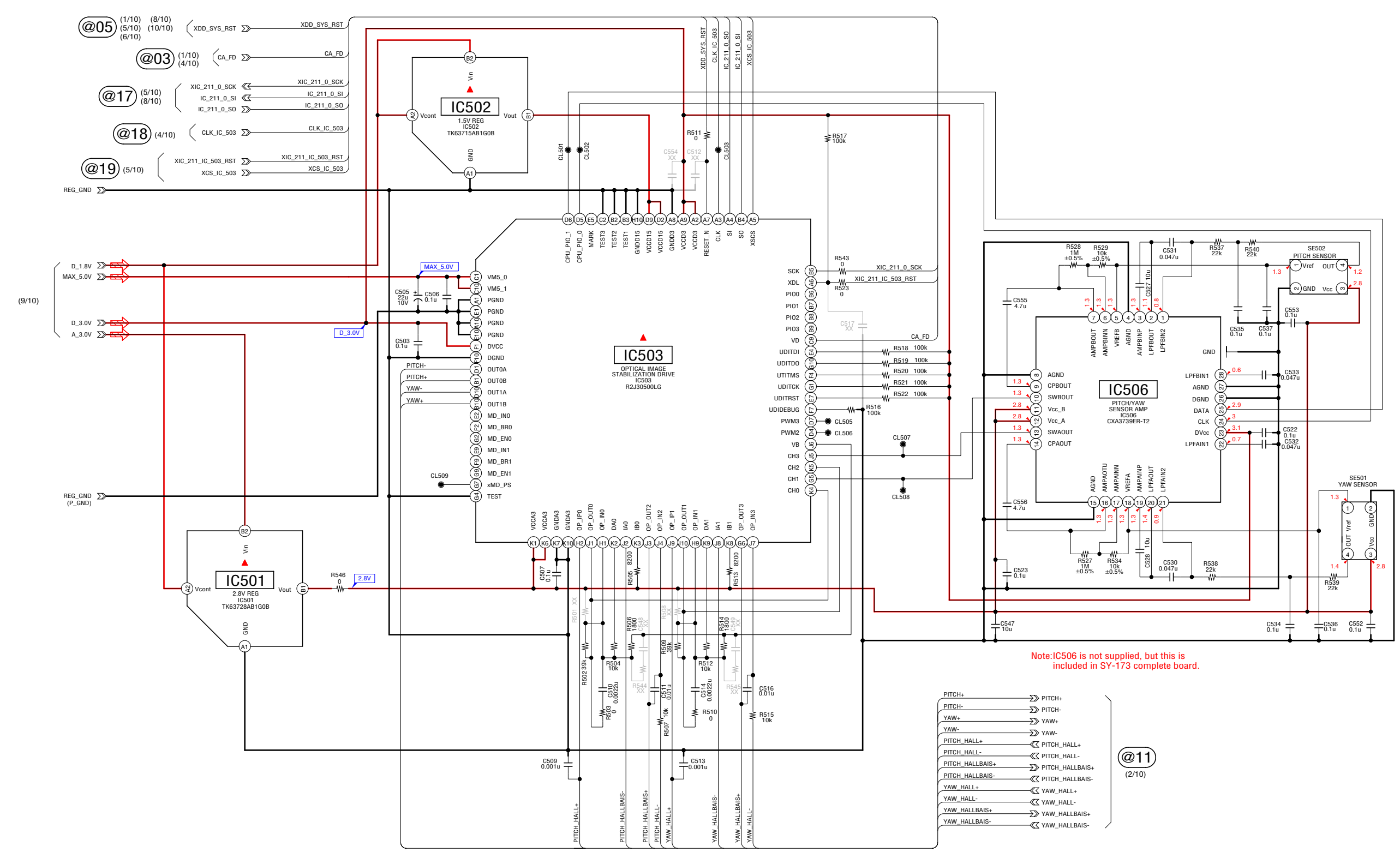

Note:IC506 is not supplied, but this is included in SY-173 complete board.

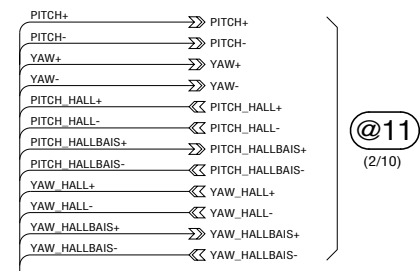



**SY-173 BOARD (5/10)**  
**CPU (SIGNAL PROCESS 2)**  
 XX MARK:NO MOUNT

▲:Voltage measurement of the CSP ICs and the Transistors with ▲mark, are not possible.

Note:IC211 is not supplied, but this is included in SY-173 complete board.

A  
B  
C  
D  
E  
F  
G  
H  
I  
J  
K

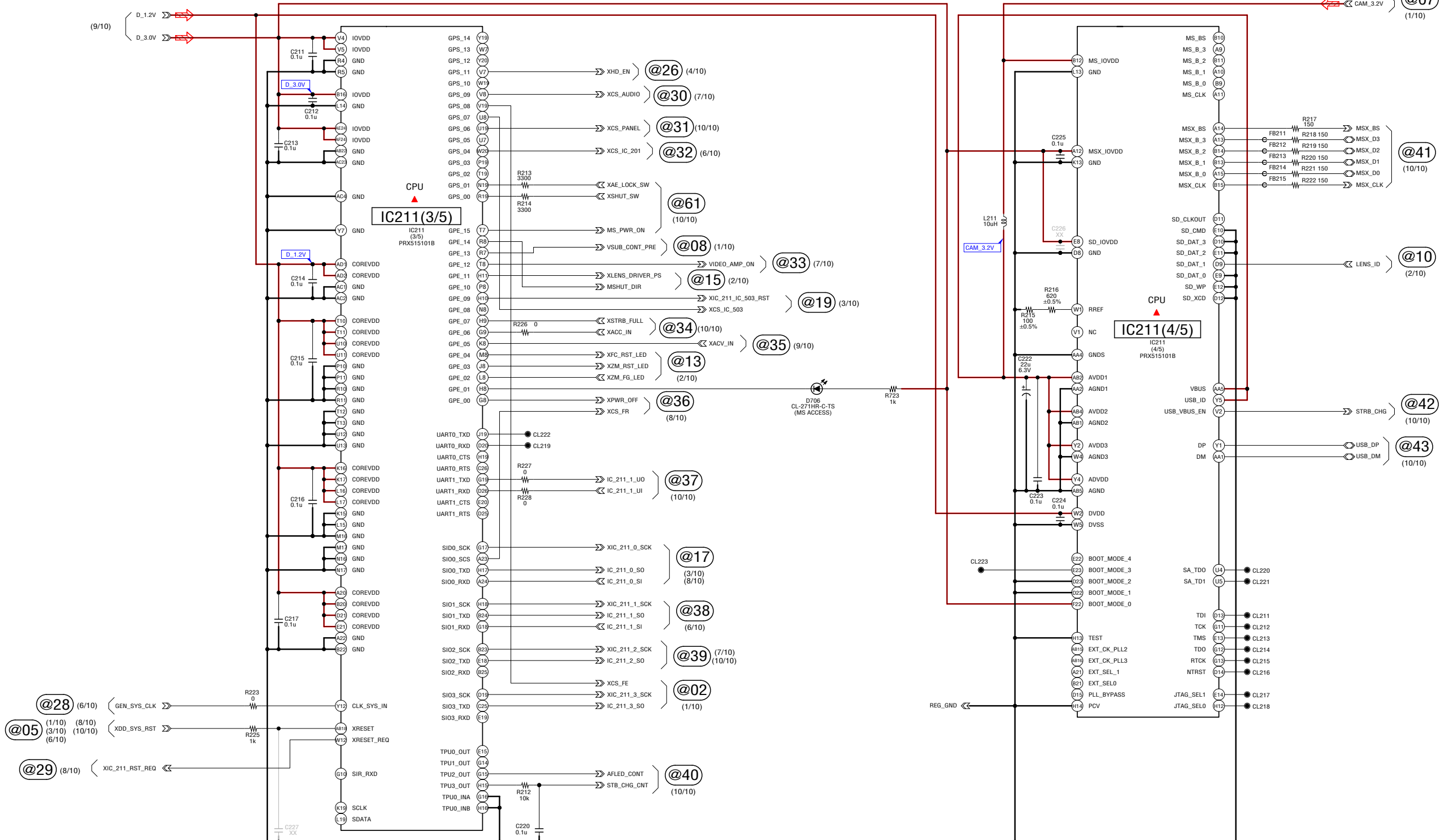



**SY-173 BOARD (6/10)**  
 CPU (POWER SUPPLY), BATTERY IN, CLOCK  
 XX MARK:NO MOUNT

▲:Voltage measurement of the CSP ICs and the Transistors with ▲ mark, are not possible.  
 Note:IC211 is not supplied, but this is included in SY-173 complete board.

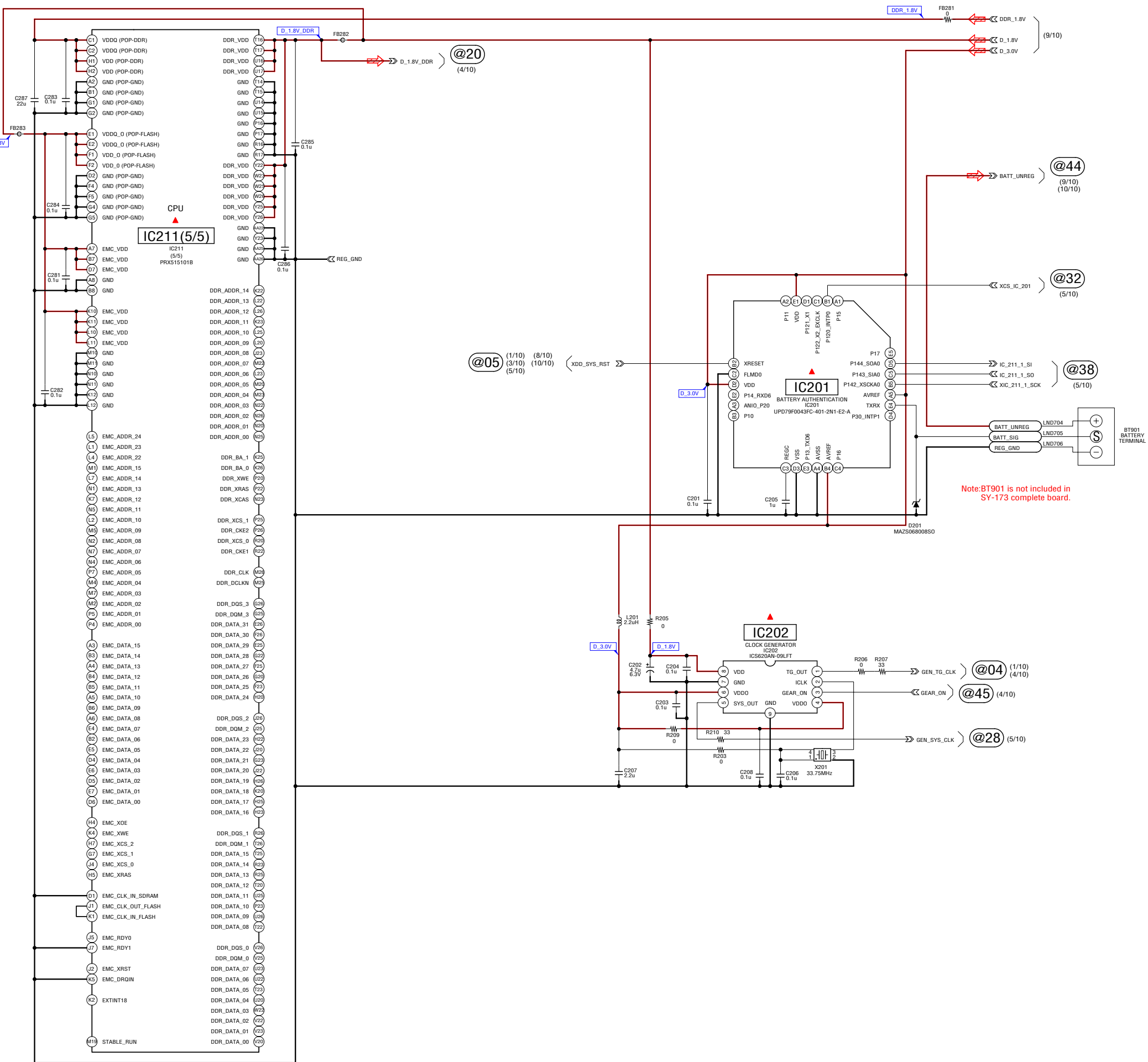
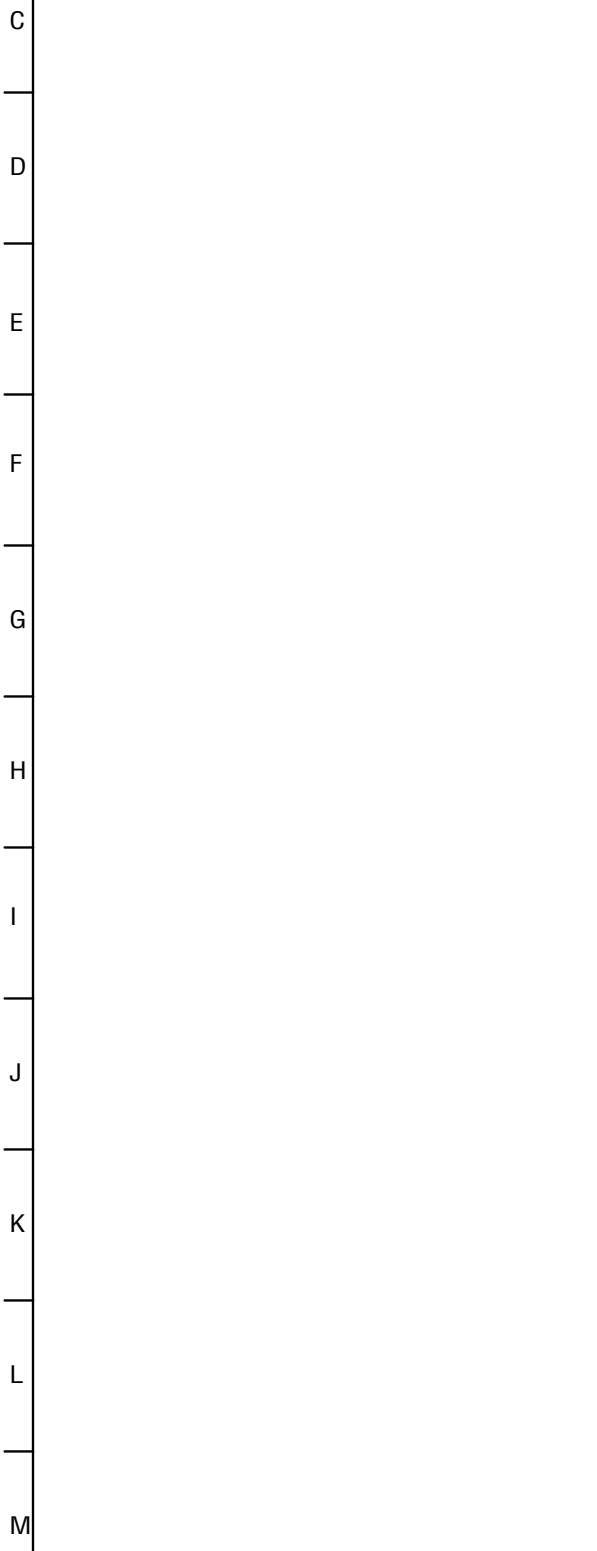



# SY-173 BOARD (7/10)

AUDIO, VIDEO

XX MARK:NO MOUNT

NO MARK:REC/PB MODE

▲:Voltage measurement of the CSP ICs and the Transistors with ▲mark, are not possible.

A  
B  
C  
D  
E  
F  
G  
H

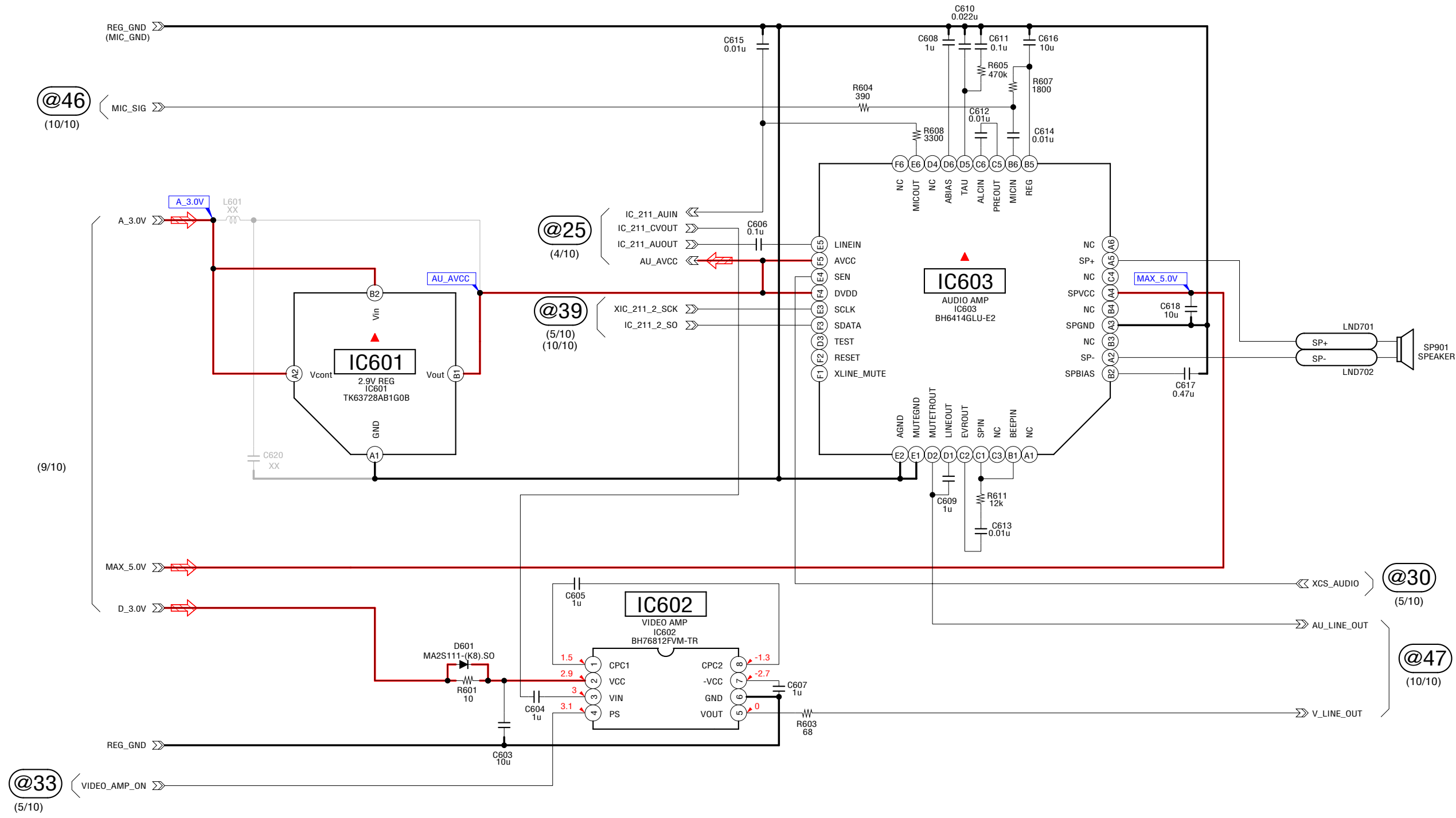

# SY-173 BOARD (8/10)

## FRONT CONTROL

XX MARK:NO MOUNT  
NO MARK:REC/PB MODE

▲:Voltage measurement of the CSP ICs and the Transistors with ▲mark, are not possible.

A  
B  
C  
D  
E  
F  
G  
H  
I  
J

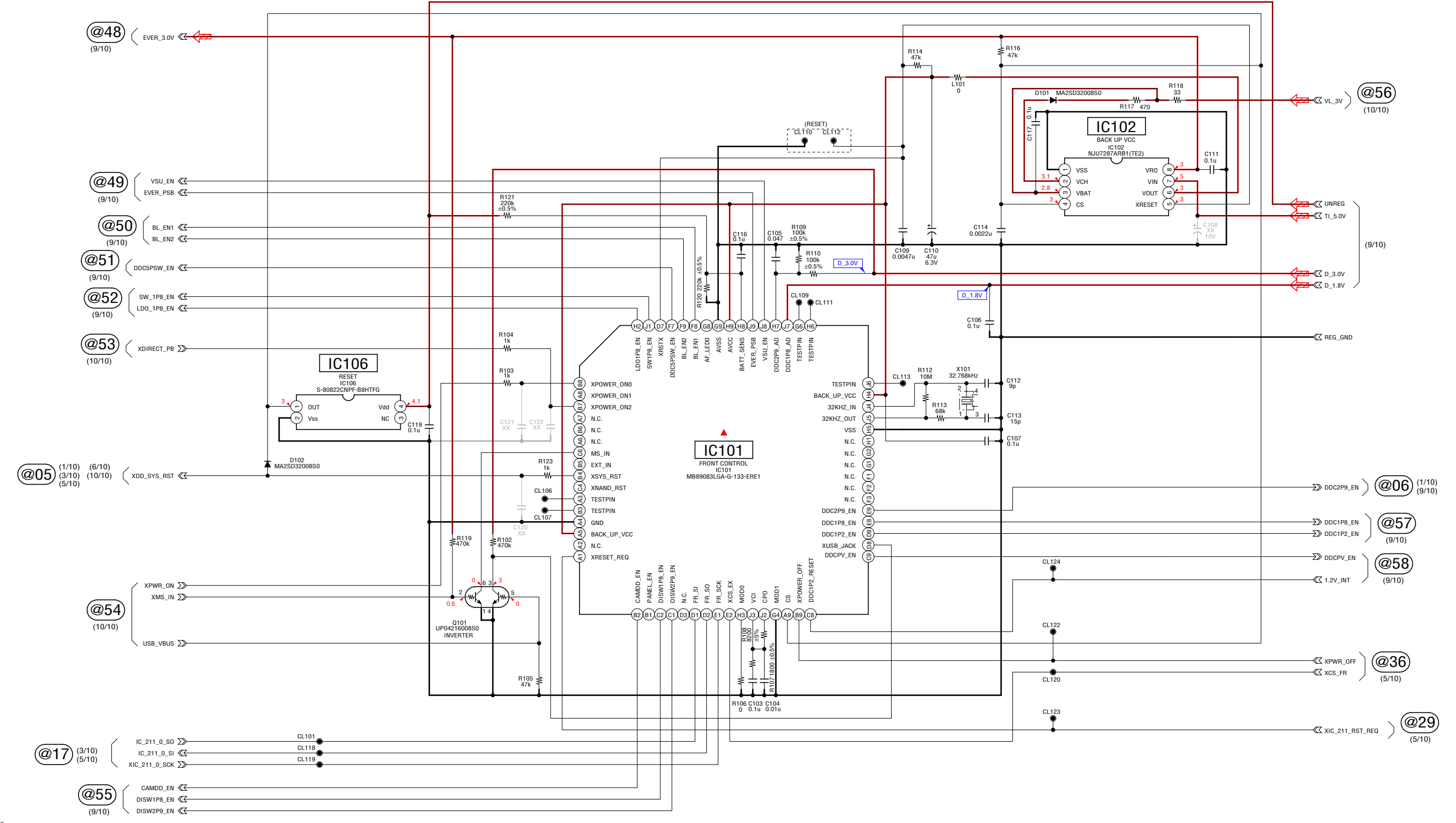

# SY-173 BOARD (9/10)

## DC/DC CONVERTER

XX MARK:NO MOUNT  
 NO MARK:REC/PB MODE  
 R:REC MODE  
 P:PB MODE  
 \* :IMPOSSIBLE TO MEASURE THE VOLTAGE AT THE MARKED POINTS.

▲:Voltage measurement of the CSP ICs and the Transistors with ▲ mark, are not possible.

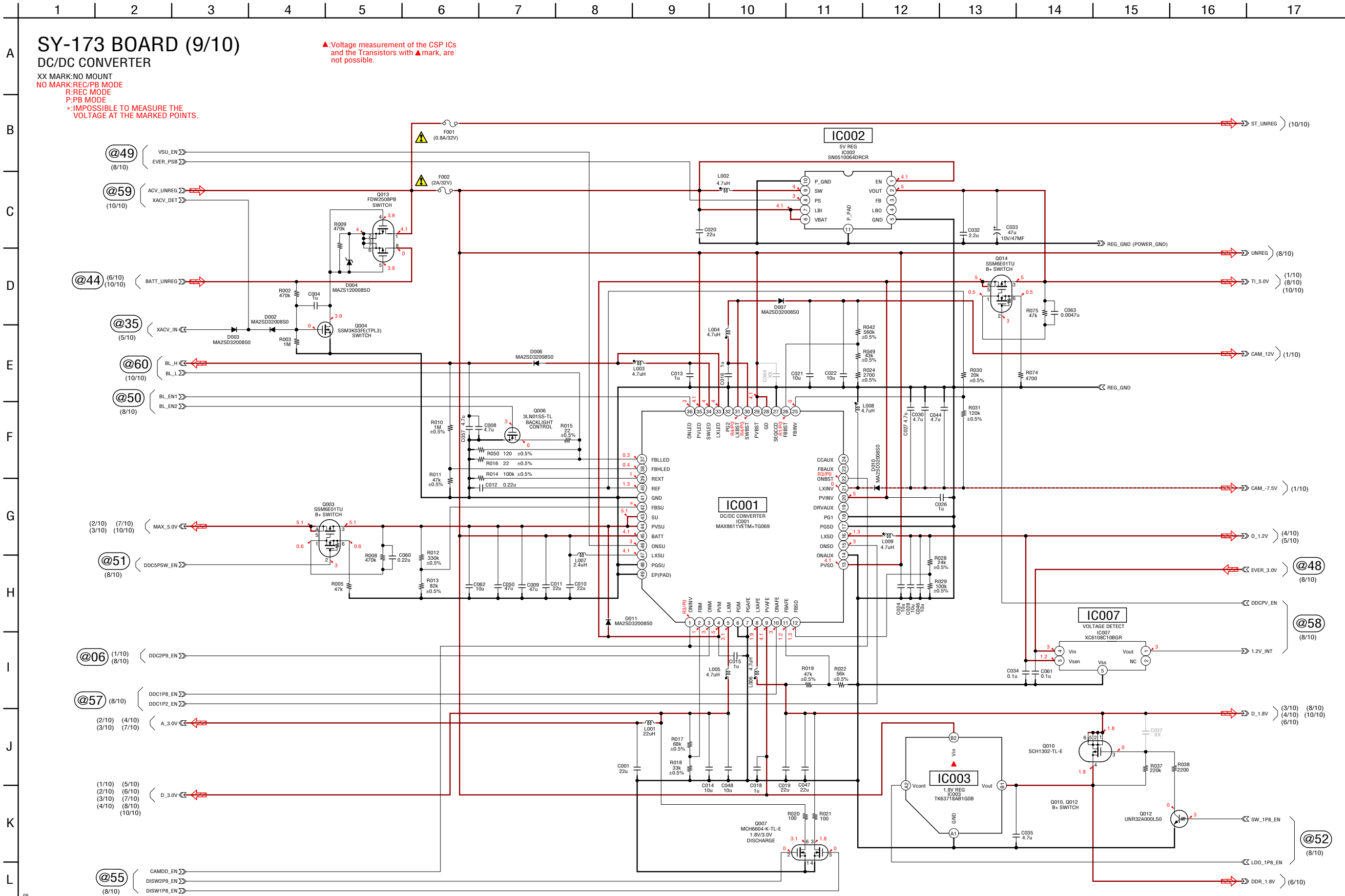

**SY-173 BOARD (10/10)**  
**CONNECTOR**  
 XX MARK:NO MOUNT  
 NO MARK:REC/PB MODE

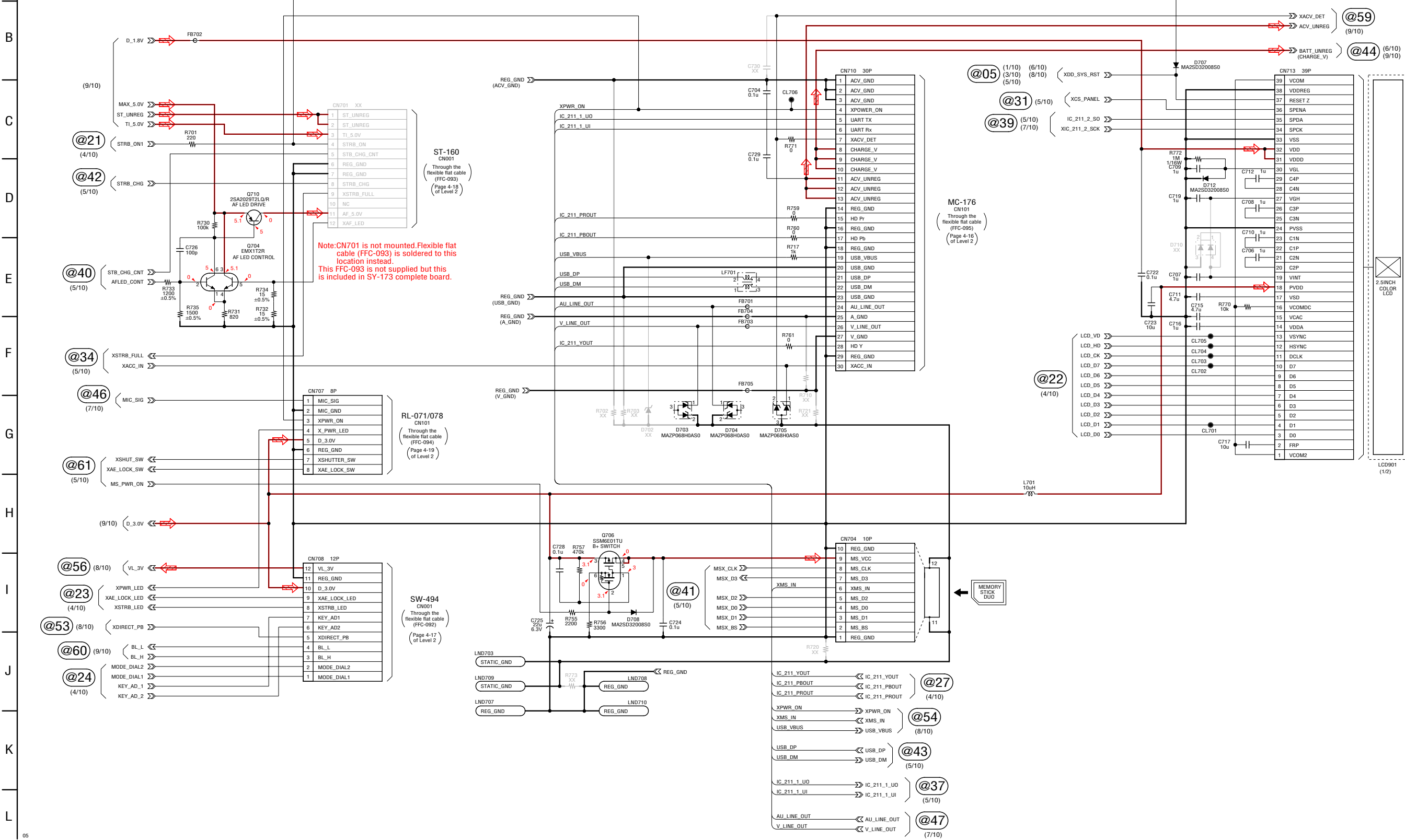

## 4-3. PRINTED WIRING BOARDS

### Link

• [CD-701 FLEXIBLE BOARD](#)

• [SY-173 BOARD \(SIDE B\)](#)

• [SY-173 BOARD \(SIDE A\)](#)

• [COMMON NOTE FOR PRINTED WIRING BOARDS](#)

• [MOUNTED PARTS LOCATION](#)

## 4-3. PRINTED WIRING BOARDS

### 4-3. PRINTED WIRING BOARDS

**THIS NOTE IS COMMON FOR PRINTED WIRING BOARDS**

- : Uses unleaded solder.
- : Circuit board
- : Flexible board
- : Pattern from the side which enables seeing.
- : pattern of the rear side  
(The other layers' patterns are not indicated)
- Through hole is omitted.
- Circled numbers refer to waveforms.
- There are a few cases that the part printed on diagram isn't mounted in this model.
- : panel designation

- Chip parts.

Transistor

Diode



# SY-173 BOARD (SIDE A)

Note: CN701 is not mounted. Flexible flat cable (FFC-093) is soldered to this location instead. This FFC-093 is not supplied, but this is included in SY-173 complete board.

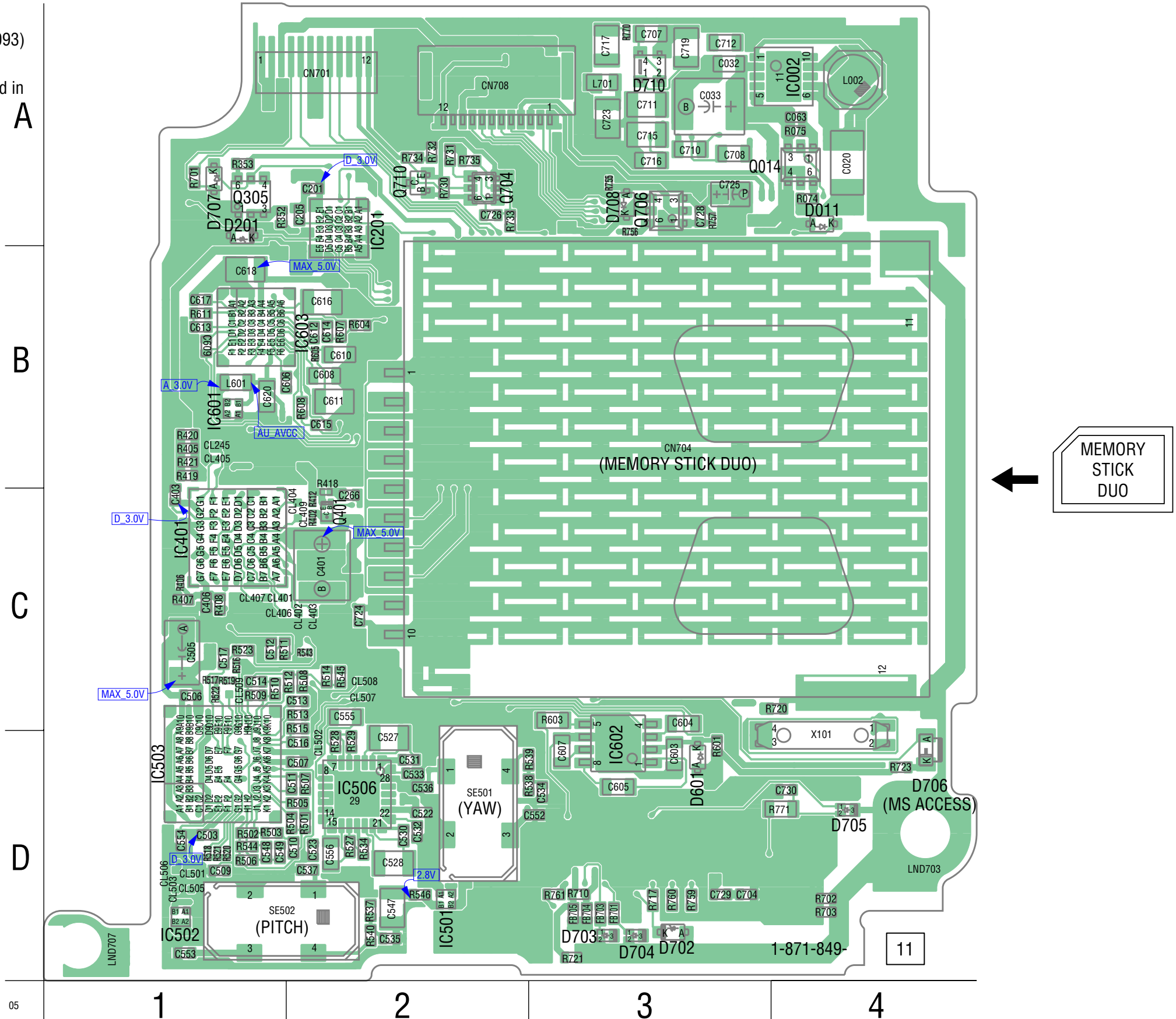



# SY-173 BOARD (SIDE B)

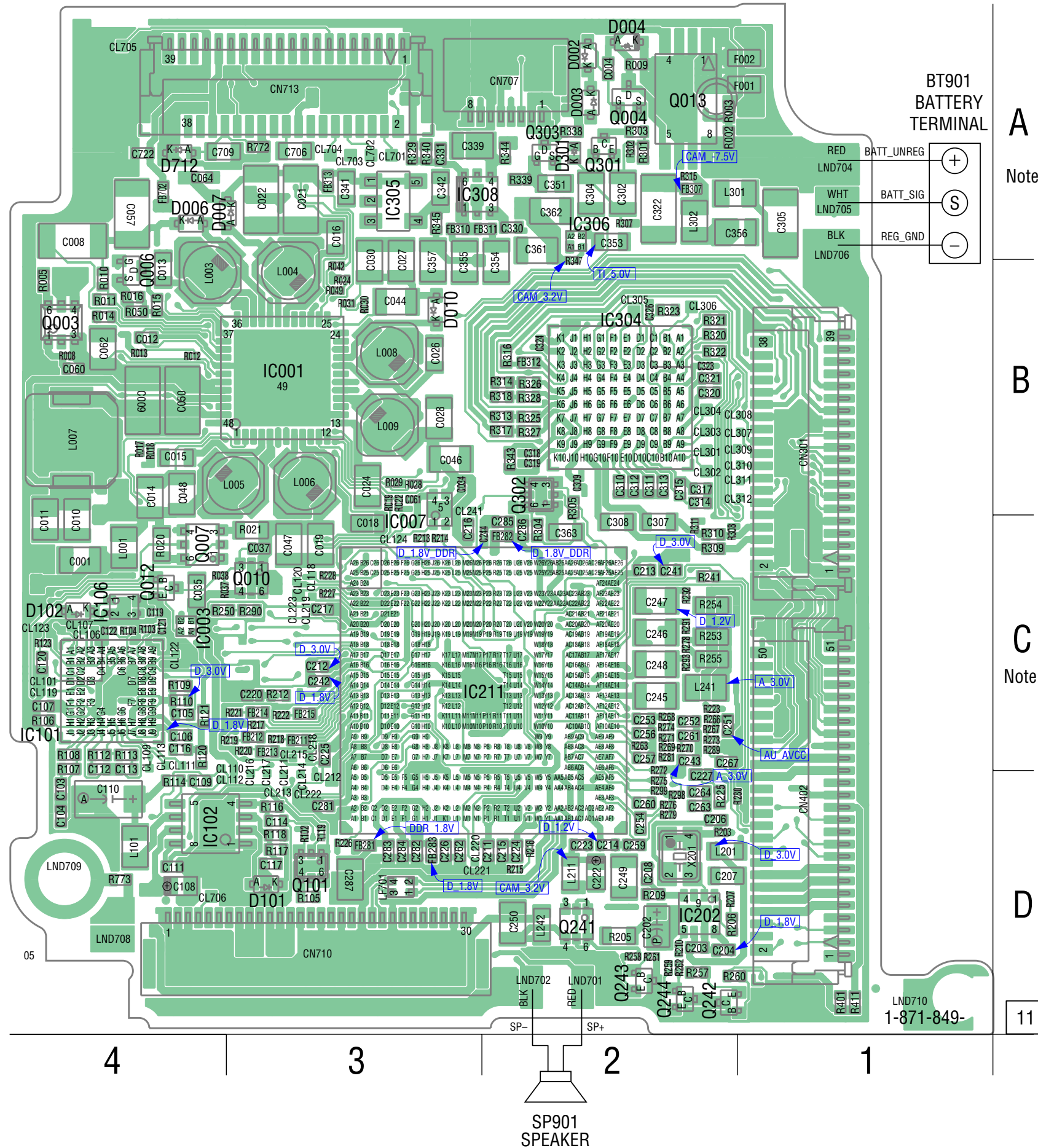

**A**  
Note: BT901 is not included in SY-173 complete board.

**B**  
**C**  
Note: IC211 is not supplied, but this is included in SY-173 complete board.

**D**  
**11**

## 4-3. PRINTED WIRING BOARDS

### 4-4. MOUNTED PARTS LOCATION

no mark : side A  
\* mark : side B

#### SY-173 BOARD

* C001	C-4	* C259	D-2	C610	B-2	* IC101	C-4	* R037	C-4	* R307	A-2
* C004	A-2	* C260	D-2	C611	B-2	* IC102	D-4	* R038	C-4	* R309	C-2
* C008	A-4	* C261	C-2	C612	B-2	* IC106	C-4	* R042	B-3	* R310	C-2
* C009	B-4	* C262	D-3	C613	B-1	IC201	A-2	* R049	B-3	* R313	B-2
* C010	C-4	* C263	D-2	C614	B-2	* IC202	D-2	* R050	B-4	* R314	B-2
* C011	C-4	* C264	D-2	C615	B-2	* IC211	C-3	R074	A-4	* R316	B-2
* C012	B-4	C266	C-2	C616	B-2	* IC304	B-2	R075	A-4	* R317	B-2
* C013	B-4	* C267	C-2	C617	B-1	* IC305	A-3	* R102	D-3	* R318	B-2
* C014	B-4	* C281	D-3	C618	B-1	* IC306	A-2	* R103	C-4	* R320	B-2
* C015	B-4	* C282	D-3	C704	D-3	* IC308	A-3	* R104	C-4	* R321	B-2
* C016	A-3	* C283	D-3	* C706	A-3	IC401	C-1	* R105	D-3	* R322	B-2
* C018	C-3	* C284	D-3	C707	A-3	IC501	D-2	* R106	C-4	* R323	B-2
* C019	C-3	* C285	C-2	C708	A-3	IC502	D-1	* R107	C-4	* R325	B-2
C020	A-4	* C286	C-2	* C709	A-4	IC503	D-1	* R108	C-4	* R326	B-2
* C021	A-3	* C287	D-3	C710	A-3	IC506	D-2	* R109	C-4	* R327	B-2
* C022	A-3	* C302	A-2	C711	A-3	IC601	B-1	* R110	C-4	* R328	B-2
* C024	B-3	* C304	A-2	C712	A-3	IC602	D-3	* R112	C-4	* R329	A-3
* C026	B-3	* C305	A-1	C715	A-3	IC603	B-1	* R113	C-4	* R338	A-2
* C027	B-3	* C307	C-2	C716	A-3			* R114	D-4	* R339	A-2
* C028	B-3	* C308	C-2	C717	A-3	* L001	C-4	* R116	D-3	* R343	B-2
* C030	B-3	* C309	B-2	C719	A-3	L002	A-4	* R117	D-3	* R344	A-2
C032	A-3	* C310	B-2	* C722	A-4	* L003	B-4	* R118	D-3	* R345	A-3
C033	A-3	* C311	B-2	C723	A-3	* L004	B-3	* R119	D-3	* R347	B-2
* C034	B-3	* C312	B-2	C724	C-2	* L005	B-3	* R120	C-4	R352	A-1
* C035	C-4	* C313	B-2	C725	A-3	* L006	B-3	* R121	C-4	R353	A-1
* C044	B-3	* C315	B-2	C726	A-2	* L007	B-4	* R123	C-4	* R401	D-1
* C046	B-3	* C317	B-2	C728	A-3	* L008	B-3	* R203	D-2	R402	C-2
* C047	C-3	* C318	B-2	C729	D-3	* L009	B-3	* R205	D-2	R405	B-1
* C048	B-4	* C319	B-2			* L101	D-4	* R206	D-2	R407	C-1
* C050	B-4	* C320	B-2	* CN301	B-1	* L201	D-2	* R207	D-2	R408	C-1
* C057	A-4	* C321	B-2	* CN402	D-1	* L211	D-2	* R209	D-2	* R411	D-1
* C060	B-4	* C322	A-2	CN701	A-2	* L241	C-2	* R210	D-2	R412	C-2
* C061	B-3	* C323	B-2	CN704	B-3	* L242	D-2	* R212	C-3	R418	C-2
* C062	B-4	* C324	B-2	* CN707	A-2	* L301	A-2	* R213	C-3	R419	B-1
C063	A-4	* C330	A-2	CN708	A-2	* L302	A-2	* R214	C-3	R420	B-1
* C103	D-4	* C331	A-3	* CN710	D-3	L701	A-3	* R215	D-2	R421	B-1
* C104	D-4	* C339	A-3	* CN713	A-3			* R216	D-2	R502	D-1
* C105	C-4	* C341	A-3			* LF701	D-3	* R217	C-3	R503	D-1
* C106	C-4	* C342	A-3	* D002	A-2			* R218	C-3	R504	D-2
* C107	C-4	* C351	A-2	* D003	A-2	* Q003	B-4	* R219	C-4	R505	D-2
* C109	D-4	* C353	A-2	* D004	A-2	* Q004	A-2	* R220	C-3	R506	D-1
* C110	D-4	* C354	B-2	* D006	A-4	* Q006	B-4	* R221	C-3	R507	D-2
* C111	D-4	* C355	B-3	* D007	A-4	* Q007	C-4	* R222	C-3	R509	C-1
* C112	C-4	* C356	A-2	* D010	B-3	* Q010	C-3	* R223	C-2	R510	C-1
* C113	C-4	* C357	B-3	D011	A-4	* Q012	C-4	* R225	D-2	R511	C-1
* C114	D-3	* C361	A-2	* D101	D-3	* Q013	A-2	* R226	D-3	R512	C-1
* C116	C-4	* C362	A-2	* D102	C-4	Q014	A-4	* R227	C-3	R513	C-2
* C117	D-3	* C363	C-2	D201	A-1	* Q101	D-3	* R228	C-3	R514	C-2
* C119	C-4	C401	C-2	* D301	A-2	* Q241	D-2	* R241	C-2	R515	C-2
C201	A-2	C403	C-1	D601	D-3	* Q242	D-2	* R250	C-4	R516	C-1
* C202	D-2	C503	D-1	D703	D-3	* Q243	D-2	* R253	C-2	R517	C-1
* C203	D-2	C505	C-1	D704	D-3	* Q244	D-2	* R254	C-2	R518	D-1
* C204	D-2	C506	C-1	D705	D-4	* Q301	A-2	* R257	D-2	R519	C-1
C205	A-2	C507	D-2	D706	D-4	* Q302	B-2	* R258	D-2	R520	D-1
* C206	D-2	C509	D-1	D707	A-1	* Q303	A-2	* R259	D-2	R521	D-1
* C207	D-2	C510	D-2	D708	A-3	Q305	A-1	* R260	D-2	R522	C-1
* C208	D-2	C511	D-2	* D712	A-4	Q401	C-2	* R261	D-2	R523	C-1
* C211	D-2	C513	C-2			Q704	A-2	* R262	D-2	R527	D-2
* C212	C-3	C514	C-1	* F001	A-1	Q706	A-3	* R263	C-2	R528	D-2
* C213	C-2	C516	D-2	* F002	A-1	Q710	A-2	* R266	C-2	R529	D-2
* C214	D-2	C522	D-2					* R267	C-2	R534	D-2
* C215	D-2	C523	D-2	* FB211	C-3	* R002	A-2	* R268	C-2	R537	D-2
* C216	C-3	C527	D-2	* FB212	C-3	* R003	A-2	* R269	C-2	R538	D-2
* C217	C-3	C528	D-2	* FB213	C-3	* R005	B-4	* R270	C-2	R539	D-2
* C220	C-3	C530	D-2	* FB214	C-3	* R008	B-4	* R271	C-2	R540	D-2
* C222	D-2	C531	D-2	* FB215	C-3	* R009	A-2	* R272	D-2	R543	C-2
* C223	D-2	C532	D-2	* FB281	D-3	* R010	B-4	* R273	C-2	R546	D-2
* C224	D-2	C533	D-2	* FB282	C-2	* R011	B-4	* R274	C-2	R601	D-3
* C225	C-3	C534	D-3	* FB283	D-3	* R012	B-4	* R275	D-2	R603	C-3
* C241	C-2	C535	D-2	* FB307	A-2	* R013	B-4	* R276	D-2	R604	B-2
* C242	C-3	C536	D-2	* FB310	A-3	* R014	B-4	* R278	C-2	R605	B-2
* C243	C-2	C537	D-2	* FB311	A-3	* R015	B-4	* R279	D-2	R607	B-2
* C244	C-2	C547	D-2	* FB312	B-2	* R016	B-4	* R280	D-2	R608	B-2
* C245	C-2	C552	D-3	* FB313	A-3	* R017	B-4	* R290	C-3	R611	B-1
* C246	C-2	C553	D-1	* FB701	D-3	* R018	B-4	* R291	C-2	R701	A-1
* C247	C-2	C555	C-2	* FB702	A-4	* R019	B-3	* R292	C-2	R717	D-3
* C249	D-2	C556	D-2	FB703	D-3	* R020	C-4	* R293	C-2	R723	D-4
* C250	D-2	C603	D-3	FB704	D-3	* R021	C-3	* R298	D-2	R730	A-2
* C251	C-2	C604	C-3	FB705	D-3	* R022	B-3	* R299	D-2	R731	A-2
* C252	C-2	C605	D-3			* R024	B-3	* R301	A-2	R732	A-2
* C253	C-2	C606	B-1	* IC001	B-3	* R028	B-3	* R302	A-2	R733	A-2
* C254	D-2	C607	D-3	IC002	A-4	* R029	B-3	* R303	A-2	R734	A-2
* C256	C-2	C608	B-2	* IC003	C-4	* R030	B-3	* R304	C-2	R735	A-2
* C257	C-2	C609	B-1	* IC007	C-3	* R031	B-3	* R305	B-2	R755	A-3

## 4-3. PRINTED WIRING BOARDS

no mark : side A  
\* mark : side B

### SY-173 BOARD

R756	A-3
R757	A-3
R759	D-3
R760	D-3
R761	D-3
R770	A-3
R771	D-4
* R772	A-3
SE501	D-2
SE502	D-1
X101	D-4
* X201	D-2

## 5. REPAIR PARTS LIST

### NOTE:

- -XX, -X mean standardized parts, so they may have some differences from the original one.
- Items marked "\*" are not stocked since they are seldom required for routine service. Some delay should be anticipated when ordering these items.
- The mechanical parts with no reference number in the exploded views are not supplied.
- Due to standardization, replacements in the parts list may be different from the parts specified in the diagrams or the components used on the set.
- CAPACITORS:  
uF:  $\mu$ F
- COILS  
uH:  $\mu$ H
- RESISTORS  
All resistors are in ohms.  
METAL: metal-film resistor  
METAL OXIDE: Metal Oxide-film resistor  
F: nonflammable
- SEMICONDUCTORS  
In each case, u:  $\mu$ , for example:  
uA...:  $\mu$ A... , uPA... ,  $\mu$ PA... ,  
uPB... ,  $\mu$ PB... ,  $\mu$ PC... ,  $\mu$ PC... ,  
uPD... ,  $\mu$ PD...
- Abbreviation  
AR : Argentine model  
AUS : Australian model  
BR : Brazilian model  
CH : Chinese model  
CND : Canadian model  
EE : East European model  
HK : Hong Kong model  
J : Japanese model  
JE : Tourist model  
KR : Korea model  
NE : North European model  
TW : Taiwan model

When indicating parts by reference number, please include the board name.

The components identified by mark  $\Delta$  or dotted line with mark  $\Delta$  are critical for safety. Replace only with part number specified.

Les composants identifiés par une marque  $\Delta$  sont critiques pour la sécurité. Ne les remplacer que par une pièce portant le numéro spécifié.

- Color Indication of Appearance Parts  
Example:  
(SILVER) : Cabinet's Color  
(Silver) : Parts Color

# CD-701

## 5-2. ELECTRICAL PARTS LIST

Ref. No.	Part No.	Description
	A-1253-768-A	CCD BLOCK ASSY
	(Not supplied)	CD-701 FLEXIBLE BOARD, COMPLETE
*****		
(CD-701 flexible complete board and IC003 are not supplied, but they are included in CCD block assy.)		

### < CAPACITOR >

C001	1-164-943-81	CERAMIC CHIP	0.01uF	10%	16V
C003	1-100-505-91	CERAMIC CHIP	0.1uF	20%	16V
C005	1-125-777-11	CERAMIC CHIP	0.1uF	10%	10V
C006	1-107-826-11	CERAMIC CHIP	0.1uF	10%	16V
C007	1-164-943-81	CERAMIC CHIP	0.01uF	10%	16V
C008	1-164-943-81	CERAMIC CHIP	0.01uF	10%	16V
C009	1-100-505-91	CERAMIC CHIP	0.1uF	20%	16V

### < IC >

IC003	(Not supplied)	ICX629EQP-13 (Note)
* IC004	8-753-275-39	IC CXA3741UR-T9

### < RESISTOR >

R003	1-240-720-91	METAL CHIP	150K	5%	1/20W
R006	1-694-535-91	SHORT CHIP	0		
R007	1-240-718-91	METAL CHIP	100K	5%	1/20W

Ref. No.	Part No.	Description	Ref. No.	Part No.	Description			
	A-1253-161-A	SY-173 BOARD, COMPLETE (SERVICE) ***** (Flexible flat cable (FFC-093) and IC211 are not supplied, but they are included in SY-173 complete board.)  (Not supplied) CABLE, FLEXIBLE FLAT (FFC-093)  < CAPACITOR >	C202	1-125-926-91	TANTAL. CHIP	4.7uF	20%	6.3V
			C203	1-125-777-11	CERAMIC CHIP	0.1uF	10%	10V
			C204	1-125-777-11	CERAMIC CHIP	0.1uF	10%	10V
			C205	1-112-717-91	CERAMIC CHIP	1uF	10%	6.3V
			C206	1-125-777-11	CERAMIC CHIP	0.1uF	10%	10V
			C207	1-165-884-91	CERAMIC CHIP	2.2uF	10%	6.3V
			C208	1-125-777-11	CERAMIC CHIP	0.1uF	10%	10V
			C211	1-125-777-11	CERAMIC CHIP	0.1uF	10%	10V
			C212	1-125-777-11	CERAMIC CHIP	0.1uF	10%	10V
			C213	1-125-777-11	CERAMIC CHIP	0.1uF	10%	10V
C001	1-100-611-91	CERAMIC CHIP	22uF	20%	6.3V			
C004	1-112-717-91	CERAMIC CHIP	1uF	10%	6.3V			
C008	1-100-671-11	CERAMIC CHIP	4.7uF	20%	25V			
C009	1-100-881-91	CERAMIC CHIP	47uF	20%	6.3V			
C010	1-100-611-91	CERAMIC CHIP	22uF	20%	6.3V			
C011	1-100-611-91	CERAMIC CHIP	22uF	20%	6.3V			
C012	1-165-887-91	CERAMIC CHIP	0.22uF	10%	6.3V			
C013	1-165-908-11	CERAMIC CHIP	1uF	10%	10V			
C014	1-165-989-11	CERAMIC CHIP	10uF	10%	6.3V			
C015	1-165-908-11	CERAMIC CHIP	1uF	10%	10V			
C016	1-165-908-11	CERAMIC CHIP	1uF	10%	10V			
C018	1-165-908-11	CERAMIC CHIP	1uF	10%	10V			
C019	1-100-611-91	CERAMIC CHIP	22uF	20%	6.3V			
C020	1-100-159-91	CERAMIC CHIP	22uF	10%	6.3V			
C021	1-100-672-11	CERAMIC CHIP	10uF	20%	16V			
C022	1-100-672-11	CERAMIC CHIP	10uF	20%	16V			
C024	1-165-989-11	CERAMIC CHIP	10uF	10%	6.3V			
C026	1-165-908-11	CERAMIC CHIP	1uF	10%	10V			
C027	1-100-670-11	CERAMIC CHIP	4.7uF	20%	16V			
C028	1-165-989-11	CERAMIC CHIP	10uF	10%	6.3V			
C030	1-100-670-11	CERAMIC CHIP	4.7uF	20%	16V			
C032	1-165-884-91	CERAMIC CHIP	2.2uF	10%	6.3V			
* C033	1-112-662-91	TANTAL. CHIP	47uF	20%	10V			
* C034	1-112-716-11	CERAMIC CHIP	0.1uF	10%	6.3V			
C035	1-112-746-11	CERAMIC CHIP	4.7uF	10%	6.3V			
C044	1-100-670-11	CERAMIC CHIP	4.7uF	20%	16V			
C046	1-165-989-11	CERAMIC CHIP	10uF	10%	6.3V			
C047	1-100-611-91	CERAMIC CHIP	22uF	20%	6.3V			
C048	1-165-989-11	CERAMIC CHIP	10uF	10%	6.3V			
C050	1-100-881-91	CERAMIC CHIP	47uF	20%	6.3V			
C057	1-100-671-11	CERAMIC CHIP	4.7uF	20%	25V			
C060	1-165-887-91	CERAMIC CHIP	0.22uF	10%	6.3V			
* C061	1-112-716-11	CERAMIC CHIP	0.1uF	10%	6.3V			
C062	1-165-989-11	CERAMIC CHIP	10uF	10%	6.3V			
C063	1-100-581-81	CERAMIC CHIP	0.0047uF	10%	50V			
C103	1-125-777-11	CERAMIC CHIP	0.1uF	10%	10V			
C104	1-100-567-81	CERAMIC CHIP	0.01uF	10%	25V			
C105	1-119-923-11	CERAMIC CHIP	0.047uF	10%	10V			
C106	1-125-777-11	CERAMIC CHIP	0.1uF	10%	10V			
C107	1-125-777-11	CERAMIC CHIP	0.1uF	10%	10V			
C109	1-100-581-81	CERAMIC CHIP	0.0047uF	10%	50V			
C110	1-100-539-91	TANTAL. CHIP	47uF	20%	6.3V			
C111	1-125-777-11	CERAMIC CHIP	0.1uF	10%	10V			
C112	1-164-849-11	CERAMIC CHIP	9PF	0.5PF	50V			
C113	1-164-854-11	CERAMIC CHIP	15PF	5%	50V			
C114	1-164-939-11	CERAMIC CHIP	0.0022uF	10%	50V			
C116	1-125-777-11	CERAMIC CHIP	0.1uF	10%	10V			
C117	1-125-777-11	CERAMIC CHIP	0.1uF	10%	10V			
* C119	1-112-716-11	CERAMIC CHIP	0.1uF	10%	6.3V			
C201	1-125-777-11	CERAMIC CHIP	0.1uF	10%	10V			
C202	1-125-926-91	TANTAL. CHIP	4.7uF	20%	6.3V			
C203	1-125-777-11	CERAMIC CHIP	0.1uF	10%	10V			
C204	1-125-777-11	CERAMIC CHIP	0.1uF	10%	10V			
C205	1-112-717-91	CERAMIC CHIP	1uF	10%	6.3V			
C206	1-125-777-11	CERAMIC CHIP	0.1uF	10%	10V			
C207	1-165-884-91	CERAMIC CHIP	2.2uF	10%	6.3V			
C208	1-125-777-11	CERAMIC CHIP	0.1uF	10%	10V			
C211	1-125-777-11	CERAMIC CHIP	0.1uF	10%	10V			
C212	1-125-777-11	CERAMIC CHIP	0.1uF	10%	10V			
C213	1-125-777-11	CERAMIC CHIP	0.1uF	10%	10V			
C214	1-125-777-11	CERAMIC CHIP	0.1uF	10%	10V			
C215	1-125-777-11	CERAMIC CHIP	0.1uF	10%	10V			
C216	1-125-777-11	CERAMIC CHIP	0.1uF	10%	10V			
C217	1-125-777-11	CERAMIC CHIP	0.1uF	10%	10V			
C220	1-125-777-11	CERAMIC CHIP	0.1uF	10%	10V			
C222	1-100-962-91	TANTAL. CHIP	22uF	20%	6.3V			
C223	1-125-777-11	CERAMIC CHIP	0.1uF	10%	10V			
C224	1-125-777-11	CERAMIC CHIP	0.1uF	10%	10V			
C225	1-125-777-11	CERAMIC CHIP	0.1uF	10%	10V			
C241	1-125-777-11	CERAMIC CHIP	0.1uF	10%	10V			
C242	1-125-777-11	CERAMIC CHIP	0.1uF	10%	10V			
C243	1-125-777-11	CERAMIC CHIP	0.1uF	10%	10V			
* C244	1-112-716-11	CERAMIC CHIP	0.1uF	10%	6.3V			
C245	1-165-989-11	CERAMIC CHIP	10uF	10%	6.3V			
C246	1-100-611-91	CERAMIC CHIP	22uF	20%	6.3V			
C247	1-100-611-91	CERAMIC CHIP	22uF	20%	6.3V			
C249	1-100-611-91	CERAMIC CHIP	22uF	20%	6.3V			
C250	1-165-989-11	CERAMIC CHIP	10uF	10%	6.3V			
C251	1-125-777-11	CERAMIC CHIP	0.1uF	10%	10V			
C252	1-125-777-11	CERAMIC CHIP	0.1uF	10%	10V			
C253	1-125-777-11	CERAMIC CHIP	0.1uF	10%	10V			
C254	1-125-777-11	CERAMIC CHIP	0.1uF	10%	10V			
C256	1-125-777-11	CERAMIC CHIP	0.1uF	10%	10V			
C257	1-125-777-11	CERAMIC CHIP	0.1uF	10%	10V			
C259	1-125-777-11	CERAMIC CHIP	0.1uF	10%	10V			
C260	1-125-777-11	CERAMIC CHIP	0.1uF	10%	10V			
C261	1-125-777-11	CERAMIC CHIP	0.1uF	10%	10V			
C262	1-125-777-11	CERAMIC CHIP	0.1uF	10%	10V			
C263	1-164-937-11	CERAMIC CHIP	0.001uF	10%	50V			
C264	1-164-937-11	CERAMIC CHIP	0.001uF	10%	50V			
C266	1-164-937-11	CERAMIC CHIP	0.001uF	10%	50V			
C267	1-164-937-11	CERAMIC CHIP	0.001uF	10%	50V			
C281	1-125-777-11	CERAMIC CHIP	0.1uF	10%	10V			
C282	1-125-777-11	CERAMIC CHIP	0.1uF	10%	10V			
C283	1-125-777-11	CERAMIC CHIP	0.1uF	10%	10V			
C284	1-125-777-11	CERAMIC CHIP	0.1uF	10%	10V			
C285	1-125-777-11	CERAMIC CHIP	0.1uF	10%	10V			
C286	1-125-777-11	CERAMIC CHIP	0.1uF	10%	10V			
C287	1-100-611-91	CERAMIC CHIP	22uF	20%	6.3V			
C302	1-115-339-11	CERAMIC CHIP	0.1uF	10%	50V			
C304	1-100-591-91	CERAMIC CHIP	1uF	10%	25V			
C305	1-100-672-11	CERAMIC CHIP	10uF	20%	16V			
C307	1-107-826-11	CERAMIC CHIP	0.1uF	10%	16V			
C308	1-107-826-11	CERAMIC CHIP	0.1uF	10%	16V			
* C309	1-112-716-11	CERAMIC CHIP	0.1uF	10%	6.3V			
C310	1-100-415-11	CERAMIC CHIP	0.47uF	10%	6.3V			
C311	1-100-415-11	CERAMIC CHIP	0.47uF	10%	6.3V			
C312	1-125-777-11	CERAMIC CHIP	0.1uF	10%	10V			

# SY-173

Ref. No.	Part No.	Description			
C313	1-125-777-11	CERAMIC CHIP	0.1uF	10%	10V
C315	1-164-937-11	CERAMIC CHIP	0.001uF	10%	50V
C317	1-125-777-11	CERAMIC CHIP	0.1uF	10%	10V
* C318	1-112-716-11	CERAMIC CHIP	0.1uF	10%	6.3V
* C319	1-112-716-11	CERAMIC CHIP	0.1uF	10%	6.3V
C320	1-125-777-11	CERAMIC CHIP	0.1uF	10%	10V
C321	1-164-943-81	CERAMIC CHIP	0.01uF	10%	16V
C322	1-165-875-11	CERAMIC CHIP	10uF	10%	10V
* C323	1-112-716-11	CERAMIC CHIP	0.1uF	10%	6.3V
* C324	1-112-716-11	CERAMIC CHIP	0.1uF	10%	6.3V
C330	1-100-567-81	CERAMIC CHIP	0.01uF	10%	25V
C331	1-112-717-91	CERAMIC CHIP	1uF	10%	6.3V
C339	1-100-611-91	CERAMIC CHIP	22uF	20%	6.3V
C341	1-112-298-91	CERAMIC CHIP	1uF	10%	16V
C342	1-112-298-91	CERAMIC CHIP	1uF	10%	16V
C351	1-112-298-91	CERAMIC CHIP	1uF	10%	16V
C353	1-165-908-11	CERAMIC CHIP	1uF	10%	10V
C354	1-100-611-91	CERAMIC CHIP	22uF	20%	6.3V
C355	1-165-989-11	CERAMIC CHIP	10uF	10%	6.3V
C356	1-100-670-11	CERAMIC CHIP	4.7uF	20%	16V
C357	1-100-670-11	CERAMIC CHIP	4.7uF	20%	16V
C361	1-100-611-91	CERAMIC CHIP	22uF	20%	6.3V
C362	1-100-611-91	CERAMIC CHIP	22uF	20%	6.3V
C363	1-107-826-11	CERAMIC CHIP	0.1uF	10%	16V
C401	1-100-663-11	TANTAL. CHIP	22uF	20%	10V
C403	1-125-777-11	CERAMIC CHIP	0.1uF	10%	10V
C503	1-125-777-11	CERAMIC CHIP	0.1uF	10%	10V
C505	1-165-897-11	TANTAL. CHIP	22uF	20%	10V
C506	1-125-777-11	CERAMIC CHIP	0.1uF	10%	10V
C507	1-125-777-11	CERAMIC CHIP	0.1uF	10%	10V
C509	1-164-937-11	CERAMIC CHIP	0.001uF	10%	50V
C510	1-164-939-11	CERAMIC CHIP	0.0022uF	10%	50V
C511	1-100-567-81	CERAMIC CHIP	0.01uF	10%	25V
C513	1-164-937-11	CERAMIC CHIP	0.001uF	10%	50V
C514	1-164-939-11	CERAMIC CHIP	0.0022uF	10%	50V
C516	1-100-567-81	CERAMIC CHIP	0.01uF	10%	25V
C522	1-125-777-11	CERAMIC CHIP	0.1uF	10%	10V
C523	1-125-777-11	CERAMIC CHIP	0.1uF	10%	10V
C527	1-165-989-11	CERAMIC CHIP	10uF	10%	6.3V
C528	1-165-989-11	CERAMIC CHIP	10uF	10%	6.3V
C530	1-119-923-11	CERAMIC CHIP	0.047uF	10%	10V
C531	1-119-923-11	CERAMIC CHIP	0.047uF	10%	10V
C532	1-119-923-11	CERAMIC CHIP	0.047uF	10%	10V
C533	1-119-923-11	CERAMIC CHIP	0.047uF	10%	10V
C534	1-125-777-11	CERAMIC CHIP	0.1uF	10%	10V
C535	1-125-777-11	CERAMIC CHIP	0.1uF	10%	10V
C536	1-125-777-11	CERAMIC CHIP	0.1uF	10%	10V
C537	1-125-777-11	CERAMIC CHIP	0.1uF	10%	10V
C547	1-165-989-11	CERAMIC CHIP	10uF	10%	6.3V
C552	1-125-777-11	CERAMIC CHIP	0.1uF	10%	10V
C553	1-125-777-11	CERAMIC CHIP	0.1uF	10%	10V
C555	1-112-746-11	CERAMIC CHIP	4.7uF	10%	6.3V
C556	1-112-746-11	CERAMIC CHIP	4.7uF	10%	6.3V
C603	1-112-815-91	CERAMIC CHIP	10uF	20%	6.3V
C604	1-125-837-91	CERAMIC CHIP	1uF	10%	6.3V
C605	1-125-837-91	CERAMIC CHIP	1uF	10%	6.3V
C606	1-125-777-11	CERAMIC CHIP	0.1uF	10%	10V

Ref. No.	Part No.	Description			
C607	1-125-837-91	CERAMIC CHIP	1uF	10%	6.3V
C608	1-125-837-91	CERAMIC CHIP	1uF	10%	6.3V
C609	1-100-506-91	CERAMIC CHIP	1uF	20%	6.3V
C610	1-164-227-11	CERAMIC CHIP	0.022uF	10%	25V
C611	1-107-725-11	CERAMIC CHIP	0.1uF	10%	16V
C612	1-164-943-81	CERAMIC CHIP	0.01uF	10%	16V
C613	1-164-943-81	CERAMIC CHIP	0.01uF	10%	16V
C614	1-164-943-81	CERAMIC CHIP	0.01uF	10%	16V
C615	1-164-943-81	CERAMIC CHIP	0.01uF	10%	16V
C616	1-137-710-91	CERAMIC CHIP	10uF	20%	6.3V
C617	1-100-415-11	CERAMIC CHIP	0.47uF	10%	6.3V
C618	1-165-989-11	CERAMIC CHIP	10uF	10%	6.3V
C704	1-125-777-11	CERAMIC CHIP	0.1uF	10%	10V
C706	1-112-298-91	CERAMIC CHIP	1uF	10%	16V
C707	1-112-298-91	CERAMIC CHIP	1uF	10%	16V
C708	1-112-298-91	CERAMIC CHIP	1uF	10%	16V
C709	1-112-298-91	CERAMIC CHIP	1uF	10%	16V
C710	1-112-298-91	CERAMIC CHIP	1uF	10%	16V
C711	1-100-670-11	CERAMIC CHIP	4.7uF	20%	16V
C712	1-112-298-91	CERAMIC CHIP	1uF	10%	16V
C715	1-100-670-11	CERAMIC CHIP	4.7uF	20%	16V
C716	1-112-298-91	CERAMIC CHIP	1uF	10%	16V
C717	1-100-966-91	CERAMIC CHIP	10uF	20%	10V
C719	1-100-591-91	CERAMIC CHIP	1uF	10%	25V
C722	1-125-777-11	CERAMIC CHIP	0.1uF	10%	10V
C723	1-165-989-11	CERAMIC CHIP	10uF	10%	6.3V
C724	1-125-777-11	CERAMIC CHIP	0.1uF	10%	10V
C725	1-100-786-91	TANTAL. CHIP	22uF	20%	6.3V
C726	1-164-931-11	CERAMIC CHIP	100PF	10%	50V
C728	1-125-777-11	CERAMIC CHIP	0.1uF	10%	10V
C729	1-125-777-11	CERAMIC CHIP	0.1uF	10%	10V
< CONNECTOR >					
* CN301	1-817-544-71	CONNECTOR, FPC (ZIF) 39P			
* CN402	1-817-283-71	CONNECTOR, FPC (ZIF) 51P			
* CN704	1-819-990-21	MEMORY STICK DUO CONNECTOR 10P			
* CN707	1-816-655-51	FFC/FPC CONNECTOR (LIF) 8P			
* CN708	1-816-644-51	FFC/FPC CONNECTOR (LIF) 12P			
* CN710	1-819-572-51	CONNECTOR, FFC/FPC (LIF) 30P			
* CN713	1-817-544-71	CONNECTOR, FPC (ZIF) 39P			
< DIODE >					
D002	6-500-813-01	DIODE MA2SD32008SO			
D003	6-500-813-01	DIODE MA2SD32008SO			
D004	8-719-056-59	DIODE MAZS120008SO			
D006	6-500-813-01	DIODE MA2SD32008SO			
D007	6-500-813-01	DIODE MA2SD32008SO			
D010	6-500-813-01	DIODE MA2SD32008SO			
D011	6-500-813-01	DIODE MA2SD32008SO			
D101	6-500-813-01	DIODE MA2SD32008SO			
D102	6-500-813-01	DIODE MA2SD32008SO			
D201	8-719-056-54	DIODE MAZS068008SO			
D301	6-501-106-01	DIODE 1SS387CT (TL3SONY)			
D601	8-719-056-23	DIODE MA2S111-(K8).SO			
D703	6-501-080-01	DIODE MAZP068H0ASO			
D704	6-501-080-01	DIODE MAZP068H0ASO			
D705	6-501-080-01	DIODE MAZP068H0ASO			

Ref. No.	Part No.	Description	Ref. No.	Part No.	Description				
D706	6-501-216-01	DIODE CL-271HR-C-TS (MS ACCESS)	L005	1-457-066-21	INDUCTOR	4.7uH			
D707	6-500-813-01	DIODE MA2SD32008S0	L006	1-457-066-21	INDUCTOR	4.7uH			
D708	6-500-813-01	DIODE MA2SD32008S0	* L007	1-457-436-21	COIL, CHOKE	2.4uH			
D712	6-500-813-01	DIODE MA2SD32008S0	L008	1-457-066-21	INDUCTOR	4.7uH			
		< FUSE >	L009	1-457-066-21	INDUCTOR	4.7uH			
△ F001	1-576-843-21	FUSE (0.8A/32V)	L101	1-216-295-91	SHORT CHIP	0 (Note)			
△ F002	1-576-851-21	FUSE (2A/32V)	L201	1-412-983-31	INDUCTOR	2.2uH			
		< FERRITE BEAD >	L211	1-400-137-11	INDUCTOR	10uH			
FB211	1-469-580-11	INDUCTOR, FERRITE BEAD (1005)	L241	1-469-570-11	INDUCTOR	10uH			
FB212	1-469-580-11	INDUCTOR, FERRITE BEAD (1005)	L242	1-400-137-11	INDUCTOR	10uH			
FB213	1-469-580-11	INDUCTOR, FERRITE BEAD (1005)	L301	1-400-678-11	INDUCTOR	100uH			
FB214	1-469-580-11	INDUCTOR, FERRITE BEAD (1005)	L302	1-400-678-11	INDUCTOR	100uH			
FB215	1-469-580-11	INDUCTOR, FERRITE BEAD (1005)	L701	1-400-137-11	INDUCTOR	10uH			
FB281	1-218-990-81	SHORT CHIP 0 (Note)			< LINE FILTER >				
FB282	1-469-081-21	INDUCTOR, FERRITE BEAD (1005)	LF701	1-456-583-11	COMMON MODE CHOKE COIL				
FB283	1-469-081-21	INDUCTOR, FERRITE BEAD (1005)			< TRANSISTOR >				
FB307	1-400-331-11	FERRITE, EMI (SMD) (1005)	Q003	6-550-576-01	TRANSISTOR	SSM6E01TU			
FB310	1-400-331-11	FERRITE, EMI (SMD) (1005)	Q004	8-729-047-68	TRANSISTOR	SSM3K03FE (TPL3)			
FB311	1-400-331-11	FERRITE, EMI (SMD) (1005)	Q006	8-729-055-32	TRANSISTOR	3LN01SS-TL			
FB312	1-400-620-21	INDUCTOR, FERRITE BEAD (1005)	Q007	6-550-674-01	TRANSISTOR	MCH6604-K-TL-E			
FB313	1-400-331-11	FERRITE, EMI (SMD) (1005)	Q010	6-551-674-01	TRANSISTOR	SCH1302-TL-E			
FB701	1-469-580-11	INDUCTOR, FERRITE BEAD (1005)	Q012	6-550-236-01	TRANSISTOR	UNR32A000LS0			
FB702	1-400-331-11	FERRITE, EMI (SMD) (1005)	Q013	6-550-844-01	TRANSISTOR	FDW2508P/GNL			
FB703	1-469-580-11	INDUCTOR, FERRITE BEAD (1005)	Q014	6-550-576-01	TRANSISTOR	SSM6E01TU			
FB704	1-469-580-11	INDUCTOR, FERRITE BEAD (1005)	Q101	8-729-054-52	TRANSISTOR	UP04216008S0			
FB705	1-469-580-11	INDUCTOR, FERRITE BEAD (1005)	Q241	6-551-674-01	TRANSISTOR	SCH1302-TL-E			
		< IC >	Q242	6-550-232-01	TRANSISTOR	2SA2029T2LQ/R			
* IC001	6-710-930-01	IC MAX8611VETM+TG069	Q243	6-550-232-01	TRANSISTOR	2SA2029T2LQ/R			
* IC002	6-709-726-01	IC SN0510064DRCR	Q244	6-550-232-01	TRANSISTOR	2SA2029T2LQ/R			
* IC003	6-710-847-01	IC TK63718AB1G0B	Q301	6-550-119-01	TRANSISTOR	DTC144EMT2L			
* IC007	6-710-970-01	IC XC6108C10BGR	Q302	8-729-054-47	TRANSISTOR	UP04213008S0			
IC101	6-807-554-01	IC MB89083LGA-G-133-ERE1	Q303	6-550-791-01	TRANSISTOR	SSM3J15FV (TL3SONYZ)			
* IC102	6-710-971-01	IC NJU7287ARB1 (TE2)	Q305	6-550-674-01	TRANSISTOR	MCH6604-K-TL-E			
* IC106	6-711-152-01	IC S-80822CNP-F-B8HTFG	* Q401	6-551-224-01	TRANSISTOR	RN2110ACT (TL3SONY)			
* IC201	6-807-231-01	IC uPD79F0043FC-401-2N1-E2-A	Q704	8-729-053-52	TRANSISTOR	HN1C01FE-Y/GR (TPLR3)			
* IC202	6-710-976-01	IC ICS620AN-09LFT	Q706	6-550-576-01	TRANSISTOR	SSM6E01TU			
IC211	(Not supplied)	IC PRX515101B	Q710	6-550-232-01	TRANSISTOR	2SA2029T2LQ/R			
* IC304	6-709-616-01	IC VSP00M21ZWDR			< RESISTOR >				
* IC305	6-710-852-01	IC NJM2831F125 (TE1)	R002	1-218-985-11	RES-CHIP	470K	5%	1/16W	
* IC306	6-710-849-01	IC TK63733AB1G0B	R003	1-218-989-11	RES-CHIP	1M	5%	1/16W	
* IC308	6-710-845-01	IC TK70628HCL-G	R005	1-218-973-11	RES-CHIP	47K	5%	1/16W	
IC401	6-708-988-01	IC LV8053LG-TLM-E	R008	1-240-726-91	METAL CHIP	470K	5%	1/20W	
* IC501	6-710-813-01	IC TK63728AB1G0B	R009	1-218-985-11	RES-CHIP	470K	5%	1/16W	
* IC502	6-709-769-01	IC TK63715AB1G0B	R010	1-218-989-11	RES-CHIP	1M	5%	1/16W	
* IC503	6-709-026-01	IC R2J30500LG	R011	1-208-927-11	METAL CHIP	47K	0.5%	1/16W	
IC506	8-753-276-73	IC CXA3739ER-T2	* R012	1-245-673-11	METAL CHIP	330K	0.5%	1/20W	
* IC601	6-710-813-01	IC TK63728AB1G0B	* R013	1-240-828-11	METAL CHIP	82K	0.5%	1/20W	
IC602	6-707-834-01	IC BH76812FVM-STR	R014	1-208-935-11	METAL CHIP	100K	0.5%	1/16W	
IC603	6-707-336-01	IC BH6414GLU-SE2	R015	1-208-643-11	METAL CHIP	22	0.5%	1/16W	
		< COIL >	R016	1-208-643-11	METAL CHIP	22	0.5%	1/16W	
L001	1-400-676-11	INDUCTOR	22uH	R017	1-240-826-91	METAL CHIP	68K	0.5%	1/20W
L002	1-457-066-21	INDUCTOR	4.7uH	R018	1-240-820-11	METAL CHIP	33K	0.5%	1/20W
L003	1-457-066-21	INDUCTOR	4.7uH	R019	1-240-822-11	METAL CHIP	47K	0.5%	1/20W
L004	1-457-066-21	INDUCTOR	4.7uH						

• Refer to page 5-1 for mark △.

Note: Short chips are mounted to the location where FB281 and L101 are printed.



**SY-173**

Ref. No.	Part No.	Description			
R020	1-216-809-11	METAL CHIP	100	5%	1/10W
R021	1-216-809-11	METAL CHIP	100	5%	1/10W
R022	1-240-824-91	METAL CHIP	56K	0.5%	1/20W
R024	1-240-794-11	METAL CHIP	2.7K	0.5%	1/20W
* R028	1-240-817-11	METAL CHIP	24K	0.5%	1/20W
R029	1-240-830-11	METAL CHIP	100K	0.5%	1/20W
R030	1-240-815-91	METAL CHIP	20K	0.5%	1/20W
R031	1-245-563-11	METAL CHIP	120K	0.5%	1/20W
R037	1-240-722-91	METAL CHIP	220K	5%	1/20W
R038	1-240-699-91	METAL CHIP	2.2K	5%	1/20W
* R042	1-245-622-11	METAL CHIP	560K	0.5%	1/20W
* R049	1-245-672-91	METAL CHIP	43K	0.5%	1/20W
R050	1-208-661-11	METAL CHIP	120	0.5%	1/16W
R074	1-218-961-11	RES-CHIP	4.7K	5%	1/16W
R075	1-218-973-11	RES-CHIP	47K	5%	1/16W
R102	1-240-726-91	METAL CHIP	470K	5%	1/20W
R103	1-240-695-91	METAL CHIP	1K	5%	1/20W
R104	1-240-695-91	METAL CHIP	1K	5%	1/20W
R105	1-218-973-11	RES-CHIP	47K	5%	1/16W
R106	1-218-990-81	SHORT CHIP	0		
R107	1-208-893-11	METAL CHIP	1.8K	0.5%	1/16W
R108	1-218-964-11	RES-CHIP	8.2K	5%	1/16W
R109	1-208-935-11	METAL CHIP	100K	0.5%	1/16W
R110	1-208-935-11	METAL CHIP	100K	0.5%	1/16W
R112	1-245-604-11	METAL CHIP	10M	5%	1/16W
R113	1-218-975-11	RES-CHIP	68K	5%	1/16W
R114	1-218-973-11	RES-CHIP	47K	5%	1/16W
R116	1-218-973-11	RES-CHIP	47K	5%	1/16W
R117	1-218-949-11	RES-CHIP	470	5%	1/16W
R118	1-218-935-11	RES-CHIP	33	5%	1/16W
R119	1-240-726-91	METAL CHIP	470K	5%	1/20W
R120	1-208-943-11	METAL CHIP	220K	0.5%	1/16W
R121	1-208-943-11	METAL CHIP	220K	0.5%	1/16W
R123	1-240-695-91	METAL CHIP	1K	5%	1/20W
R203	1-694-535-91	SHORT CHIP	0		
R205	1-216-864-11	SHORT CHIP	0		
R206	1-218-990-81	SHORT CHIP	0		
R207	1-240-678-91	METAL CHIP	33	5%	1/20W
R209	1-218-990-81	SHORT CHIP	0		
R210	1-240-678-91	METAL CHIP	33	5%	1/20W
R212	1-218-965-11	RES-CHIP	10K	5%	1/16W
R213	1-240-701-91	METAL CHIP	3.3K	5%	1/20W
R214	1-240-701-91	METAL CHIP	3.3K	5%	1/20W
R215	1-240-760-91	METAL CHIP	100	0.5%	1/20W
* R216	1-240-779-91	METAL CHIP	620	0.5%	1/20W
R217	1-240-685-91	METAL CHIP	150	5%	1/20W
R218	1-240-685-91	METAL CHIP	150	5%	1/20W
R219	1-240-685-91	METAL CHIP	150	5%	1/20W
R220	1-240-685-91	METAL CHIP	150	5%	1/20W
R221	1-240-685-91	METAL CHIP	150	5%	1/20W
R222	1-240-685-91	METAL CHIP	150	5%	1/20W
R223	1-694-535-91	SHORT CHIP	0		
R225	1-218-953-11	RES-CHIP	1K	5%	1/16W
R226	1-694-535-91	SHORT CHIP	0		
R227	1-694-535-91	SHORT CHIP	0		
R228	1-694-535-91	SHORT CHIP	0		
R241	1-218-939-11	RES-CHIP	68	5%	1/16W
R250	1-218-990-81	SHORT CHIP	0		

Ref. No.	Part No.	Description			
R253	1-216-801-11	METAL CHIP	22	5%	1/10W
R254	1-216-801-11	METAL CHIP	22	5%	1/10W
R257	1-218-953-11	RES-CHIP	1K	5%	1/16W
R258	1-240-699-91	METAL CHIP	2.2K	5%	1/20W
R259	1-240-699-91	METAL CHIP	2.2K	5%	1/20W
* R260	1-208-869-11	METAL CHIP	180	0.5%	1/16W
R261	1-240-764-91	METAL CHIP	150	0.5%	1/20W
R262	1-240-764-91	METAL CHIP	150	0.5%	1/20W
* R263	1-240-792-91	METAL CHIP	2.2K	0.5%	1/20W
* R266	1-240-792-91	METAL CHIP	2.2K	0.5%	1/20W
R267	1-240-824-91	METAL CHIP	56K	0.5%	1/20W
R268	1-240-824-91	METAL CHIP	56K	0.5%	1/20W
* R269	1-240-797-91	METAL CHIP	3.6K	0.5%	1/20W
R270	1-240-784-11	METAL CHIP	1K	0.5%	1/20W
R271	1-240-784-11	METAL CHIP	1K	0.5%	1/20W
R272	1-240-707-91	METAL CHIP	10K	5%	1/20W
R273	1-240-830-11	METAL CHIP	100K	0.5%	1/20W
R274	1-240-830-11	METAL CHIP	100K	0.5%	1/20W
R275	1-240-707-91	METAL CHIP	10K	5%	1/20W
R276	1-240-822-11	METAL CHIP	47K	0.5%	1/20W
R278	1-694-535-91	SHORT CHIP	0		
R279	1-240-822-11	METAL CHIP	47K	0.5%	1/20W
R280	1-694-535-91	SHORT CHIP	0		
R290	1-218-990-81	SHORT CHIP	0		
R291	1-694-535-91	SHORT CHIP	0		
R292	1-694-535-91	SHORT CHIP	0		
R293	1-694-535-91	SHORT CHIP	0		
R298	1-240-707-91	METAL CHIP	10K	5%	1/20W
R299	1-240-707-91	METAL CHIP	10K	5%	1/20W
R301	1-218-990-81	SHORT CHIP	0		
R302	1-240-729-91	METAL CHIP	1M	5%	1/20W
R303	1-218-981-11	RES-CHIP	220K	5%	1/16W
R304	1-218-959-11	RES-CHIP	3.3K	5%	1/16W
R305	1-218-956-11	RES-CHIP	1.8K	5%	1/16W
R307	1-240-718-91	METAL CHIP	100K	5%	1/20W
R309	1-218-990-81	SHORT CHIP	0		
R310	1-218-990-81	SHORT CHIP	0		
R313	1-220-802-11	RES-CHIP	3.3	5%	1/16W
R314	1-220-802-11	RES-CHIP	3.3	5%	1/16W
R316	1-218-936-11	RES-CHIP	39	5%	1/16W
R317	1-220-802-11	RES-CHIP	3.3	5%	1/16W
R318	1-220-802-11	RES-CHIP	3.3	5%	1/16W
R320	1-218-990-81	SHORT CHIP	0		
R321	1-218-990-81	SHORT CHIP	0		
R322	1-218-990-81	SHORT CHIP	0		
R323	1-218-953-11	RES-CHIP	1K	5%	1/16W
R325	1-218-990-81	SHORT CHIP	0		
R326	1-218-990-81	SHORT CHIP	0		
R327	1-218-990-81	SHORT CHIP	0		
R328	1-218-990-81	SHORT CHIP	0		
R329	1-218-990-81	SHORT CHIP	0		
R338	1-218-941-81	RES-CHIP	100	5%	1/16W
R339	1-218-977-11	RES-CHIP	100K	5%	1/16W
R343	1-218-990-81	SHORT CHIP	0		
R344	1-218-990-81	SHORT CHIP	0		
R345	1-216-864-11	SHORT CHIP	0		
R347	1-694-535-91	SHORT CHIP	0		

Ref. No.	Part No.	Description			
R352	1-218-981-11	RES-CHIP	220K	5%	1/16W
R353	1-218-948-11	RES-CHIP	390	5%	1/16W
R401	1-218-948-11	RES-CHIP	390	5%	1/16W
R402	1-240-689-91	METAL CHIP	330	5%	1/20W
R405	1-208-635-11	METAL CHIP	10	0.5%	1/16W
R407	1-208-688-11	METAL CHIP	1.6K	0.5%	1/16W
R408	1-208-908-11	METAL CHIP	7.5K	0.5%	1/16W
R411	1-218-948-11	RES-CHIP	390	5%	1/16W
R412	1-240-690-11	METAL CHIP	390	5%	1/20W
R418	1-240-714-91	METAL CHIP	47K	5%	1/20W
R419	1-208-635-11	METAL CHIP	10	0.5%	1/16W
R420	1-208-635-11	METAL CHIP	10	0.5%	1/16W
R421	1-208-635-11	METAL CHIP	10	0.5%	1/16W
R502	1-208-721-11	METAL CHIP	39K	0.5%	1/16W
R503	1-218-990-81	SHORT CHIP	0		
R504	1-208-911-11	METAL CHIP	10K	0.5%	1/16W
R505	1-208-909-11	METAL CHIP	8.2K	0.5%	1/16W
R506	1-208-893-11	METAL CHIP	1.8K	0.5%	1/16W
R507	1-208-911-11	METAL CHIP	10K	0.5%	1/16W
R509	1-208-721-11	METAL CHIP	39K	0.5%	1/16W
R510	1-218-990-81	SHORT CHIP	0		
R511	1-218-990-81	SHORT CHIP	0		
R512	1-208-911-11	METAL CHIP	10K	0.5%	1/16W
R513	1-208-909-11	METAL CHIP	8.2K	0.5%	1/16W
R514	1-208-893-11	METAL CHIP	1.8K	0.5%	1/16W
R515	1-208-911-11	METAL CHIP	10K	0.5%	1/16W
R516	1-240-718-91	METAL CHIP	100K	5%	1/20W
R517	1-240-718-91	METAL CHIP	100K	5%	1/20W
R518	1-240-718-91	METAL CHIP	100K	5%	1/20W
R519	1-240-718-91	METAL CHIP	100K	5%	1/20W
R520	1-240-718-91	METAL CHIP	100K	5%	1/20W
R521	1-240-718-91	METAL CHIP	100K	5%	1/20W
R522	1-240-718-91	METAL CHIP	100K	5%	1/20W
R523	1-218-990-81	SHORT CHIP	0		
R527	1-218-989-11	RES-CHIP	1M	5%	1/16W
R528	1-218-989-11	RES-CHIP	1M	5%	1/16W
R529	1-208-911-11	METAL CHIP	10K	0.5%	1/16W
R534	1-208-911-11	METAL CHIP	10K	0.5%	1/16W
R537	1-218-969-11	RES-CHIP	22K	5%	1/16W
R538	1-218-969-11	RES-CHIP	22K	5%	1/16W
R539	1-218-969-11	RES-CHIP	22K	5%	1/16W
R540	1-218-969-11	RES-CHIP	22K	5%	1/16W
R543	1-694-535-91	SHORT CHIP	0		
R546	1-218-990-81	SHORT CHIP	0		
R601	1-218-929-11	RES-CHIP	10	5%	1/16W
R603	1-216-807-11	METAL CHIP	68	5%	1/10W
R604	1-218-948-11	RES-CHIP	390	5%	1/16W
R605	1-240-726-91	METAL CHIP	470K	5%	1/20W
R607	1-218-956-11	RES-CHIP	1.8K	5%	1/16W
R608	1-218-959-11	RES-CHIP	3.3K	5%	1/16W
R611	1-218-966-11	RES-CHIP	12K	5%	1/16W
R701	1-218-945-11	RES-CHIP	220	5%	1/16W
R717	1-218-953-11	RES-CHIP	1K	5%	1/16W
R723	1-218-953-11	RES-CHIP	1K	5%	1/16W
R730	1-218-977-11	RES-CHIP	100K	5%	1/16W
R731	1-218-952-11	RES-CHIP	820	5%	1/16W
R732	1-220-874-81	METAL CHIP	15	0.5%	1/16W
R733	1-208-889-11	METAL CHIP	1.2K	0.5%	1/16W

Ref. No.	Part No.	Description			
R734	1-220-874-81	METAL CHIP	15	0.5%	1/16W
R735	1-208-687-11	METAL CHIP	1.5K	0.5%	1/16W
R755	1-240-699-91	METAL CHIP	2.2K	5%	1/20W
R756	1-240-701-91	METAL CHIP	3.3K	5%	1/20W
R757	1-240-726-91	METAL CHIP	470K	5%	1/20W
R759	1-218-990-81	SHORT CHIP	0		
R760	1-218-990-81	SHORT CHIP	0		
R761	1-218-990-81	SHORT CHIP	0		
R770	1-240-707-91	METAL CHIP	10K	5%	1/20W
R771	1-216-864-11	SHORT CHIP	0		
R772	1-218-989-11	RES-CHIP	1M	5%	1/16W
< SENSOR >					
* SE501	1-479-022-61	SENSOR, ANGULAR VELOCITY			
* SE502	1-479-022-51	SENSOR, ANGULAR VELOCITY			
< SPEAKER >					
SP901	1-826-614-21	LOUDSPEAKER (1.0CM)			
< VIBRATOR >					
X101	1-781-525-21	VIBRATOR, CRYSTAL (32.768kHz)			
* X201	1-813-712-21	QUARTZ CRYSTAL OSCILLATOR (33.75MHz)			

**[Description of main button functions on toolbar of the Adobe Acrobat Reader Ver5.0 (for Windows)]**

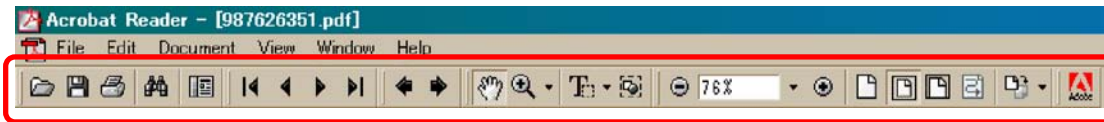

Toolbar



**Printing a text**

1. Click the Print button .
2. Specify a printer, print range, number of copies, and other options, and then click [OK].

**Application of printing:**

To set a range to be printed within a page, select the graphic selection tool  and drag on the page to enclose a range to be printed, and then click the Print button.

**Reversing the screens displayed once**

- To reverse the previous screens (operation) one by one, click the .
- To advance the reversed screens (operation) one by one, click the .

**Application to the Service Manual:**

This function allows you to go and back between circuit diagram and printed circuit board diagram, and accordingly it will be convenient for the voltage check.

**Finding a text**

1. Click the Find button .
2. Enter a character string to be found into a text box, and click the [Find]. (Specify the find options as necessary)

**Application to the Service Manual:**

To execute “find” from current page toward the previous pages, select the check box “Find Backward” and then click the “Find”.

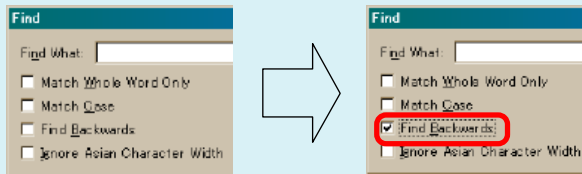





3. Open the find dialog box again, and click the [Find Again] and you can find the matched character strings displayed next. (Character strings entered previously are displayed as they are in the text box.)

**Application to the Service Manual:**

The parts on the drawing pages (block diagrams, circuit diagrams, printed circuit boards) and parts list pages in a text can be found using this find function. For example, find a Ref. No. of IC on the block diagram, and click the [Find Again] continuously, so that you can move to the Ref. No. of IC on the circuit diagram or printed circuit board diagram successively.

**Note:** The find function may not be applied to the Service Manual depending on the date of issue.

**Moving with link**

1. Select either palm tool , zoom tool , text selection tool , or graphic selection tool .
2. Place the pointer in the position in a text where the link exists (such as a button on cover and the table of contents page, or blue characters on the removal flowchart page or drawing page), and the pointer will change to the forefinger form .
3. Then, click the link. (You will go to the link destination.)

**Moving with bookmark:**

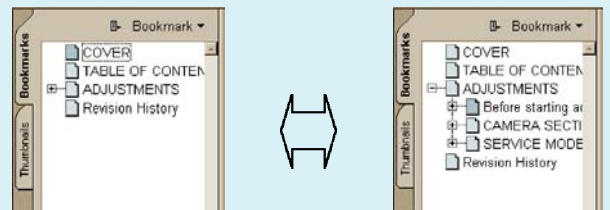

Click an item (text) on the bookmark pallet. and you can move to the link destination. Also, clicking  can display the hidden items.

(To go back to original state, click )



**Zooming or rotating the screen display**

**“Zoom in/out”**

- Click the triangle button in the zoom control box to select the display magnification. Or, you may click  or  for zooming in or out.

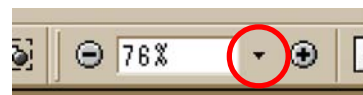





**“Rotate”**

- Click rotate tool , and the page then rotates 90 degrees each.

**Application to the Service Manual:**

The printed circuit board diagram you see now can be changed to the same direction as the set.

**Switching a page**

- To move to the first page, click the .
- To move to the last page, click the .
- To move to the previous page, click the .
- To move to the next page, click the .

# Revision History

Ver.	Date	History	Contents	S.M. Rev. issued
1.0	2007.03	Official Release	—	—