



AAT1415/AAT1415A

Product information presented is for internal use within AAT Inc. only. Details are subject to change without notice.

FIVE-CHANNEL DC-DC CONVERTER WITH A 2.5V LDO

FEATURES

- Complete PWM Power Control Circuitry
- Input Voltage Range: 1.5 to 5.5V
- Low Start-Up Voltage: 1.2V
- Independent On / Off Control for All Channels
- Internal Soft-Start for All Channels
- Power-OK Outputs & Overload Protection
- Adjustable Operation Frequency with External Components Ranging from 100kHz to 1MHz
- VQFN-40 5*5 Package Available

APPLICATIONS

- Digital Still Cameras
- Digital Videos
- PDAs
- Portable Devices

GENERAL DESCRIPTION

The AAT1415/AAT1415A provides an integrated 5-channel pulse-width-modulation (PWM) solution and a low noise LDO for the power supply of DC-DC converter. This device improves performance and size compared to conventional controllers in battery design. The AAT1415/AAT1415A has three current mode PWM converters (CH1, CH2, and CH3) and two voltage mode PWM converters (CH4 and CH5). Each current-mode channel has on-chip synchronous power FETs. The five channels include:

- CH1: Boost /buck selectable DC-DC converter, which activates PWM function at 1.2V when it is configured as a boost converter.
- CH2: Boost / buck selectable DC-DC converter.
- CH3: Buck DC-DC converter.
- CH4: Boost DC-DC controller for the CCD positive bias.
- CH5: Inverting DC-DC controller for the CCD negative bias.

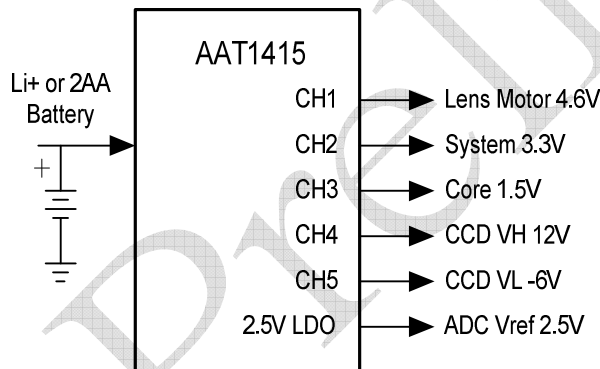

PIN CONFIGURATION

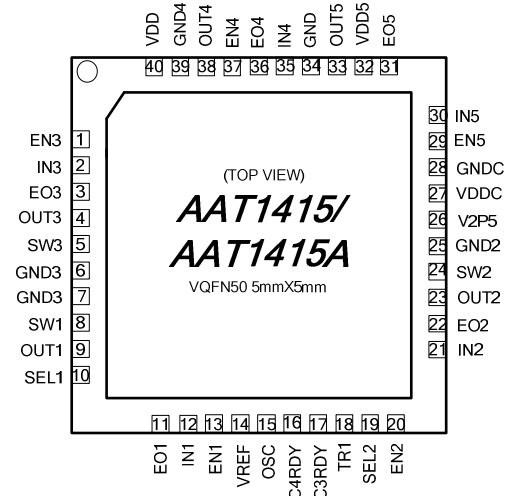

**AAT1415/AAT1415A****ORDERING INFORMATION**

| DEVICE TYPE | PART NUMBER | PACKAGE | PACKING | TEMP. RANGE | MARKING | MARKING DESCRIPTION |
|-------------|-------------------|--------------------|---------------------|------------------|---------------------------|--|
| AAT1415 | AAT1415 -Q8-T | Q8: VQFN 40-5*5 | T: Tape and Reel | -40 °C to +85 °C | AAT1415 XXXXX XXXX | 1. Part Name 2. Lot No. (6~9 Digits) 3. Date Code (4 Digits) |
| AAT1415A | AAT1415A -Q8-T | Q8: VQFN 40-5*5 | T: Tape and Reel | -40 °C to +85 °C | AAT1415A XXXXX XXXX | 1. Part Name 2. Lot No. (6~9 Digits) 3. Date Code (4 Digits) |

NOTE: All AAT products are lead free and halogen free.

ABSOLUTE MAXIMUM RATINGS

| PARAMETER | SYMBOL | VALUE | UNIT |
|---|---------------|-----------------------|------|
| Supply Voltage (VDD) | V_{MDD} | -0.3 to + 6.0 | V |
| Pin Voltage 1 (OUT1, OUT2, VDDC, C3RDY, C4RDY, VDD5, SEL1, SEL2, TR1) | V_{I1} | -0.3 to + 6.0 | V |
| Pin Voltage 2 (OUT3, VREF, OSC, EO_, EN_, IN_) | V_{I2} | -0.3 to (VDD + 0.3) | V |
| Pin Voltage 3 (OUT5) | V_{I3} | -0.3 to (VDD5 + 0.3) | V |
| Pin Voltage 4 (OUT4) | V_{I4} | -0.3 to (VDD + 0.3) | V |
| Pin Voltage 5 (V2P5) | V_{I5} | -0.3 to (VDDC + 0.3) | V |
| Pin Voltage 6 (GND_) | V_{I6} | - 0.3 to + 0.3 | V |
| Input Voltage 7 (SW1) | V_{I7} | -0.3 to (OUT1 + 0.3V) | V |
| Input Voltage 8 (SW2) | V_{I8} | -0.3 to (OUT2 + 0.3V) | V |
| Input Voltage 9 (SW3) | V_{I9} | -0.3 to (OUT3 + 0.3V) | V |
| SW1 Current | I_{SW1} | 3.6 | A |
| SW2 Current | I_{SW2} | 3.6 | A |
| SW3 Current | I_{SW3} | 3.6 | A |
| Open Drain NMOS Current (C3RDY, C4RDY) | I_{OD} | 10 | mA |
| Operating Temperature Range | T_C | -40 °C to + 85 °C | °C |
| Storage Temperature Range | $T_{STORAGE}$ | -65 °C to + 150 °C | °C |

**AAT1415/AAT1415A****RECOMMENDED OPERATING CONDITIONS**

| PARAMETER | SYMBOL | MIN | MAX | UNIT |
|--------------------------------|--------|-----|-----|------|
| Operating Free-Air Temperature | T_C | -40 | +85 | °C |

ELECTRICAL CHARACTERISTICS

($T_C = 25^\circ\text{C}$, $V_{DD} = \text{OUT1} = \text{OUT2} = \text{OUT3} = 3.6\text{V}$, unless otherwise specified.)

General Item

| PARAMETER | SYMBOL | TEST CONDITION | MIN | TYP | MAX | UNIT |
|---|-------------|---|------|------|------|---------------|
| Input Voltage Range | V_{VDD} | | 2.6 | | 5.5 | V |
| VDD Under-Voltage Lockout | V_{UVLO} | | 2.35 | 2.40 | 2.45 | V |
| VDD Under-Voltage Lockout Hysteresis | V_{UHYS} | | | 80 | | mV |
| CH1 Minimum Startup Voltage | V_{START} | | | 1.2 | 1.5 | V |
| Shutdown Supply Current Into VDD | I_{SHDN} | | | 0.10 | 10.0 | μA |
| Supply Current Into VDD with CH1 Enable | I_{CH1} | EN1 = 3.6V, IN1 = 1.5V | | 450 | 700 | μA |
| Supply Current Into VDD with CH2 Enable | I_{CH2} | EN2 = 3.6V, IN2 = 1.5V | | 400 | 650 | μA |
| Supply Current Into VDD with CH3 Enable | I_{CH3} | EN3 = 3.6V, IN3 = 1.5V | | 400 | 650 | μA |
| Supply Current Into VDD with CH1 And CH4 Enable | I_{CH4} | EN1 = EN4 = 3.6V, IN1 = IN4 = 1.5V | | 550 | 800 | μA |
| Supply Current Into VDD with CH1 And CH5 Enable | I_{CH5} | EN1 = EN5 = 3.6V, IN1 = 1.5V, IN5 = -0.5V | | 550 | 800 | μA |
| Supply Current Into VDD with CH1 And LDO Enable | I_{CHC} | EN1 = 3.6V, IN1 = 1.5V | | 100 | 300 | μA |

Reference Voltage

| PARAMETER | SYMBOL | TEST CONDITION | MIN | TYP | MAX | UNIT |
|---------------------------|-----------|--|------|------|------|------|
| Reference Output Voltage | V_{REF} | $I_{REF} = 20\mu\text{A}$ | 1.23 | 1.25 | 1.27 | V |
| Reference Load Regulation | | $10\mu\text{A} < I_{REF} < 200\mu\text{A}$ | | 4.50 | 10.0 | %/mV |
| Reference Line Regulation | | $2.7\text{V} < V_{DD} < 5.5\text{V}$ | | 1.3 | 5.0 | %/mA |



AAT1415/AAT1415A

ELECTRICAL CHARACTERISTICS

($T_C = 25^\circ\text{C}$, $V_{DD} = \text{OUT1} = \text{OUT2} = \text{OUT3} = 3.6\text{V}$, unless otherwise specified.)

Oscillator

| PARAMETER | SYMBOL | TEST CONDITION | MIN | TYP | MAX | UNIT |
|---------------------------|------------------|--|-------|-------|-------|----------|
| OSC Discharge Trip Level | V_{ODT} | Rising Edge | 1.225 | 1.250 | 1.275 | V |
| OSC Discharge Resistance | R_{ODR} | OSC = 1.5V, $I_{\text{OSC}} = 30\text{mA}$ | | 52 | 80 | Ω |
| OSC Discharge Pulse Width | t_{OFF} | | | 150 | | ns |
| OSC Frequency | f_{osc} | $R_{\text{OSC}} = 47\text{k}\Omega$, $C_{\text{OSC}} = 100\text{pF}$ | | 500 | | kHz |

Power Fail Latch and Thermal Protection

| PARAMETER | SYMBOL | TEST CONDITION | MIN | TYP | MAX | UNIT |
|---------------------------------|-------------------|---------------------------------------|-------|---------|-------|------------------|
| CH4, CH5 Overload Condition | | Duty Cycle | | 100 | | % |
| CH1, CH2 Overload Threshold | V_{F12} | IN1, IN2, Fail Detection Voltage | 1.07 | 1.10 | 1.13 | V |
| CH3 Overload Threshold | V_{F13} | IN3 Fail Detection Voltage (AAT1415) | 1.07 | 1.10 | 1.13 | V |
| | | IN3 Fail Detection Voltage (AAT1415A) | 0.600 | 0.625 | 0.650 | V |
| Overload Protection Fault Delay | | | | 100,000 | | Cycles |
| Thermal Shutdown | T_{SHDN} | | | 160 | | $^\circ\text{C}$ |
| Thermal Hysteresis | T_{HYS} | | | 20 | | $^\circ\text{C}$ |

Logic Inputs

| PARAMETER | SYMBOL | TEST CONDITION | MIN | TYP | MAX | UNIT |
|----------------------------|------------------|----------------|-----|-----|-----|------------------|
| EN_, SEL_ Input Low Level | V_{IL} | | | | 0.4 | V |
| EN_, SEL_ Input High Level | V_{IH} | | 1.4 | | | V |
| SEL_ Input Leakage | I_{L9} | | | 0.1 | 1.0 | μA |
| EN_ Impedance to GND | R_{EN} | | 200 | 300 | 400 | $\text{k}\Omega$ |
| TR1 Output Low Voltage | V_{TRL} | 1.2mA Into TR1 | | 0.1 | 0.2 | V |



AAT1415/AAT1415A

ELECTRICAL CHARACTERISTICS

($T_C = 25^\circ\text{C}$, $V_{DD} = \text{OUT1} = \text{OUT2} = \text{OUT3} = 3.6\text{V}$, unless otherwise specified.)

CH1 (Boost / Buck)

| PARAMETER | SYMBOL | TEST CONDITION | MIN | TYP | MAX | UNIT |
|---|-----------------|---|-------|-------|-------|---------------|
| IN1 Regulation Voltage | V_{IN1} | IN1 = EO1 | 1.231 | 1.250 | 1.269 | V |
| IN1 to EO1 Transconductance | | IN1 = EO1 | | 70 | | μS |
| CH1 Maximum Duty Cycle | | Boost Mode (SEL1 = V_{DD}) | 85 | 90 | 95 | % |
| | | Buck Mode (SEL1 = GND) | | 100 | | % |
| IN1 Input Leakage Current | I_{L1} | IN1 = 0V to 1.5V | -100 | 0.01 | +100 | nA |
| Current-Sense Amplifier Transresistance | | Boost Mode (SEL1 = V_{DD}) | | 0.25 | | V/A |
| | | Buck Mode (SEL1 = GND) | | 0.5 | | V/A |
| OUT1 Leakage Current | I_{LO1} | SEL1 = GND $V_{SW1} = 0\text{V}$, OUT1 = 3.6V | | 0.1 | 5.0 | μA |
| SW1 Leakage Current | I_{LSW1} | SEL1 = GND $V_{SW1} = \text{OUT1} = 3.6\text{V}$ | | 0.1 | 5.0 | μA |
| Switch On-Resistance | $R_{ON1(N)}$ | N Channel | | 95 | | m Ω |
| | $R_{ON1(P)}$ | P Channel | | 200 | | |
| SW1 Peak Current Limit | $I_{LIMIT1(N)}$ | Boost Mode (SEL1 = V_{DD}) | | 3 | | A |
| | $I_{LIMIT1(P)}$ | Buck Mode (SEL1 = GND) | | 0.8 | | A |
| Soft-Start Interval | | | | 4,096 | | OSC Cycles |
| OUT1 Startup-to-Normal Operating Threshold | V_{UVLO1} | Rising Edge | 2.30 | 2.50 | 2.65 | V |
| OUT1 Startup-to-Normal Operating Hysteresis | V_{UHYS1} | | | 80 | | mV |
| Startup t_{OFF} | t_{OS} | $V_{DD} = 1.8\text{V}$ | | 700 | | ns |
| Startup Frequency | f_{START} | $V_{DD} = 1.8\text{V}$ | | 200 | | kHz |



AAT1415/AAT1415A

ELECTRICAL CHARACTERISTICS

($T_C = 25^\circ\text{C}$, $V_{DD} = \text{OUT2} = 3.6\text{V}$, unless otherwise specified.)

CH2 (Boost / Buck)

| PARAMETER | SYMBOL | TEST CONDITION | MIN | TYP | MAX | UNIT |
|--|-----------------|---------------------------------------|-------|-------|-------|---------------|
| IN2 Regulation Voltage | V_{IN2} | IN2 = EO2 | 1.231 | 1.250 | 1.269 | V |
| IN2 to EO2 Transconductance | | IN2 = EO2 | | 70 | | μS |
| CH2 Maximum Duty Cycle | | Boost Mode (SEL2 = V_{DD}) | 85 | 90 | 95 | % |
| | | Buck Mode (SEL2 = GND) | | 100 | | % |
| IN2 Input Leakage Current | I_{L2} | IN2 = 0V to 1.5V | -100 | 0.01 | +100 | nA |
| Current-Sense Amplifier Transresistance | | Boost Mode (SEL2 = V_{DD}) | | 0.25 | | V/A |
| | | Buck Mode (SEL2 = GND) | | 0.5 | | V/A |
| OUT2 Leakage Current | I_{LO2} | $V_{SW2} = 0\text{V}$, OUT2 = 3.6V | | 0.1 | 5.0 | μA |
| SW2 Leakage Current | I_{LSW2} | $V_{SW2} = \text{OUT2} = 3.6\text{V}$ | | 0.1 | 5.0 | μA |
| Switch On-Resistance | $R_{ON2(N)}$ | N Channel | | 95 | | m Ω |
| | $R_{ON2(P)}$ | P Channel | | 150 | | |
| SW2 Peak Current Limit | $I_{LIMIT2(N)}$ | Boost Mode (SEL2 = V_{DD}) | | 3 | | A |
| | $I_{LIMIT2(P)}$ | Buck Mode (SEL2 = GND) | | 0.8 | | A |
| Soft-Start Interval | | | | 4,096 | | OSC Cycles |
| OUT2 Under-Voltage Lockout in Buck Mode | V_{UVLO2} | SEL2 = GND | 2.45 | 2.50 | 2.55 | V |
| OUT2 Under-Voltage Lockout in Hysteresis | V_{UHYS2} | | | 80 | | mV |



AAT1415/AAT1415A

ELECTRICAL CHARACTERISTICS

($T_C = 25^\circ\text{C}$, $V_{DD} = \text{OUT3} = 3.6\text{V}$, unless otherwise specified.)

CH3 (Buck)

| PARAMETER | SYMBOL | TEST CONDITION | MIN | TYP | MAX | UNIT |
|---|-----------------|---------------------------------------|-------|-------|-------|---------------|
| IN3 Regulation Voltage | V_{IN3} | IN3 = EO3 (AAT1415) | 1.231 | 1.250 | 1.269 | V |
| | | IN3 = EO3 (AAT1415A) | 0.784 | 0.800 | 0.816 | |
| IN3 to EO3 Transconductance | | IN3 = EO3 | | 70 | | μS |
| CH3 Maximum Duty Cycle | | | | 100 | | % |
| IN3 Input Leakage Current | I_{L3} | IN3 = 0V to 1.5V | -100 | 0.01 | +100 | nA |
| Current-Sense Amplifier Transresistance | | | | 0.5 | | V/A |
| SW3 Leakage Current | I_{LSW3} | $V_{SW3} = 0\text{V to } 3.6\text{V}$ | | 0.1 | 5.0 | μA |
| Switch On-Resistance | $R_{ON3(N)}$ | N Channel | | 95 | | m Ω |
| | $R_{ON3(P)}$ | P Channel | | 150 | | |
| SW3 Current Limit | I_{LIMIT3} | | | 0.8 | | A |
| Soft-Start Interval | | | | 4,096 | | OSC Cycles |
| SW3 Peak Current Limit | $I_{LIMIT3(N)}$ | | | 0.8 | | A |
| Soft-Start Interval | | | | 2,048 | | OSC Cycles |
| C3RDY Output Low Voltage | V_{C3RDY} | 0.1mA Into C3RDY | | 0.01 | 0.10 | V |
| C3RDY Leakage Current | I_{C3RDY} | EN3 = GND | | 0.01 | 1.00 | μA |

**AAT1415/AAT1415A****ELECTRICAL CHARACTERISTICS**(T_C = 25 °C, V_{DD} = OUT3 = 3.6V, unless otherwise specified.)**CH4 (Buck)**

| PARAMETER | SYMBOL | TEST CONDITION | MIN | TYP | MAX | UNIT |
|-----------------------------|---------------------|---------------------------|-------|-------|-------|------------|
| IN4 Regulation Voltage | V _{IN4} | IN4 = EO4 | 1.231 | 1.250 | 1.269 | V |
| IN4 to EO4 Transconductance | | IN4 = EO4 | | 70 | | μS |
| CH4 Maximum Duty Cycle | | IN4 = 0V | 85 | 90 | 95 | % |
| IN4 Input Leakage Current | I _{L4} | IN4 = 0V to 1.5V | -100 | 0.01 | +100 | nA |
| OUT4 Driver Resistance | R _{ON4(N)} | I _{OUT4} = 10mA | | 5 | | Ω |
| | R _{ON4(P)} | I _{OUT4} = -10mA | | 5 | | Ω |
| Soft-Start Interval | | | | 4,096 | | OSC Cycles |
| C4RDY Output Low Voltage | V _{C4RDY} | 0.1mA Into C4RDY | | 0.01 | 0.10 | V |
| C4RDY Leakage Current | I _{C4RDY} | EN4 = GND | | 0.01 | 1.00 | μA |



AAT1415/AAT1415A

ELECTRICAL CHARACTERISTICS

($T_C = 25^\circ\text{C}$, $V_{DD} = \text{OUT1} = 3.6\text{V}$, unless otherwise specified.)

CH5

| PARAMETER | SYMBOL | TEST CONDITION | MIN | TYP | MAX | UNIT |
|---------------------------------------|--------------|---------------------------|-------|-------|-------|---------------|
| IN5 Regulation Voltage | V_{IN5} | | -0.01 | 0.00 | +0.01 | V |
| IN5 to EO5 Transconductance | | | | 70 | | μS |
| Maximum Duty Cycle | | IN5 = 0V | 85 | 90 | 95 | % |
| IN5 Input Leakage Current | I_{L5} | IN5 = 0V to 0.5V | -100 | 0.1 | +100 | nA |
| OUT5 Driver Resistance | $R_{ON5(N)}$ | $I_{OUT5} = 10\text{mA}$ | | 5 | | Ω |
| | $R_{ON5(P)}$ | $I_{OUT5} = -10\text{mA}$ | | 5 | | Ω |
| Soft-Start Interval | | | | 4,096 | | OSC Cycles |
| VDD5 Under-Voltage Lockout Threshold | V_{UVLO5} | Rising Edge | 2.30 | 2.50 | 2.65 | V |
| VDD5 Under-Voltage Lockout Hysteresis | V_{UHYS5} | | | 80 | | mV |

ELECTRICAL CHARACTERISTICS

($T_C = 25^\circ\text{C}$, $V_{DD} = V_{DDC} = 3.6\text{V}$, unless otherwise specified.)

2.5V LDO

| PARAMETER | SYMBOL | TEST CONDITION | MIN | TYP | MAX | UNIT |
|-------------------------------|-------------|---|------|------|------|------|
| Input Voltage Range | V_{VDDC} | $I_{V2P5} = 10\text{mA}$ | 2.6 | | 5.5 | V |
| V2P5 Regulation Voltage | V_{V2P5} | $I_{V2P5} = 10\text{mA}$ | 2.45 | 2.50 | 2.55 | V |
| V2P5 Dropout Voltage | V_{DRO25} | $I_{V2P5} = 10\text{mA}$ | | | 50 | mV |
| V2P5 LDO Output Current | V_{V2P5} | | 100 | | | mA |
| V2P5 LDO Output Current Limit | I_{LIM25} | | | 150 | | mA |
| V2P5 VDDC PSRR | | | | 60 | | dB |
| V2P5 Line Regulation | | Measure V_{V2P5} $V_{VDDC} = 2.6\text{V} \sim 5\text{V}$ | | | 10 | %/mV |
| V2P5 Load Regulation | | Measure V_{V2P5} $I_{V2P5} = 5\text{mA} \sim 100\text{mA}$ | | | 5 | %/mA |



TYPICAL OPERATING CHARACTERISTICS

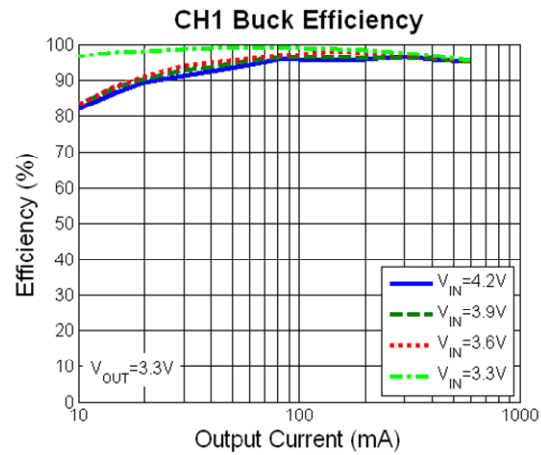
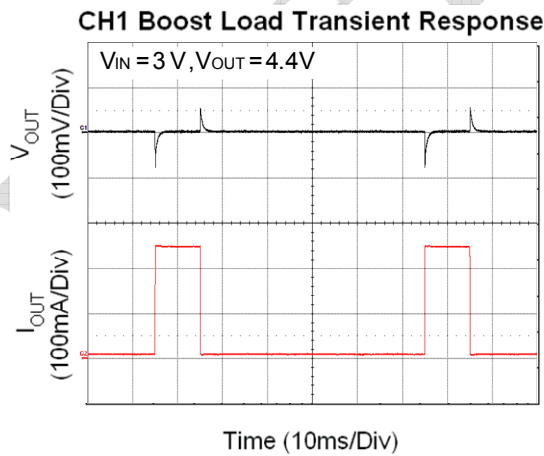
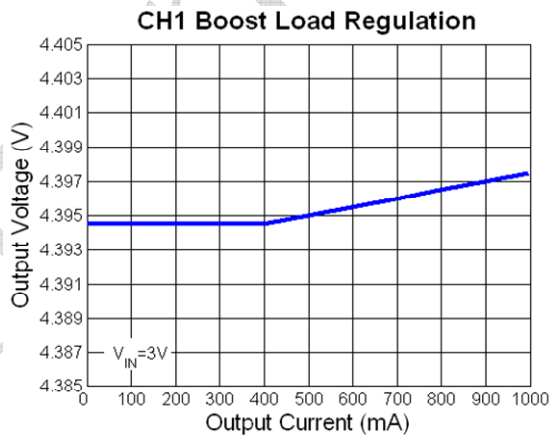
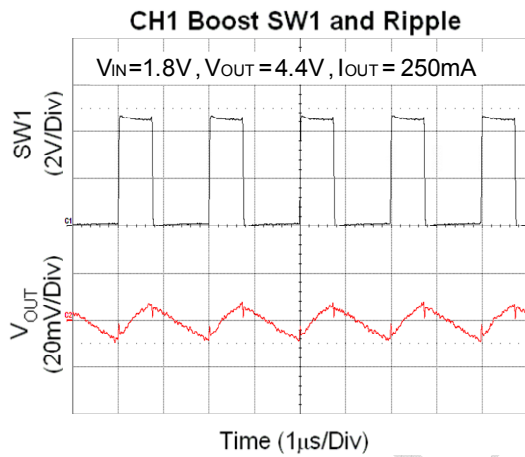
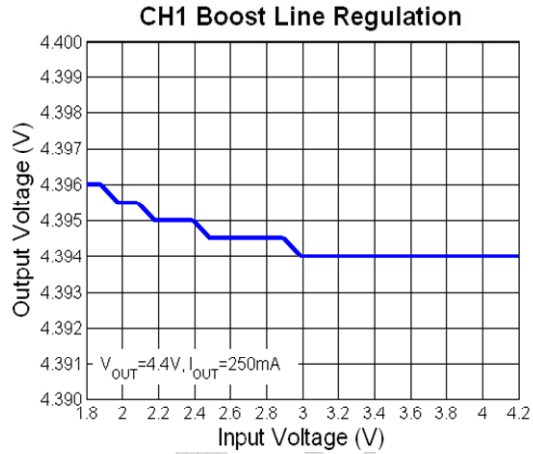
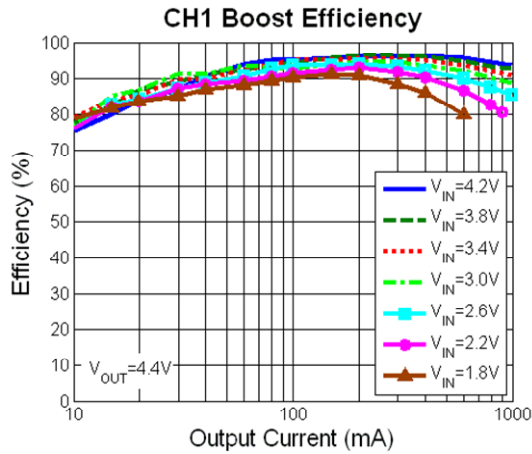



AAT1415/AAT1415A

TYPICAL OPERATING CHARACTERISTICS

CH1 Buck SW1 and Ripple

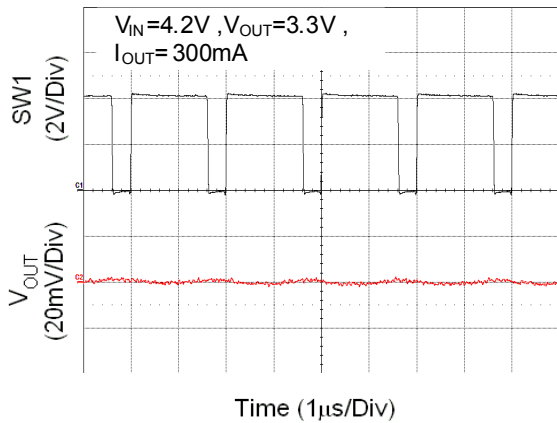

CH1 Buck Load Regulation

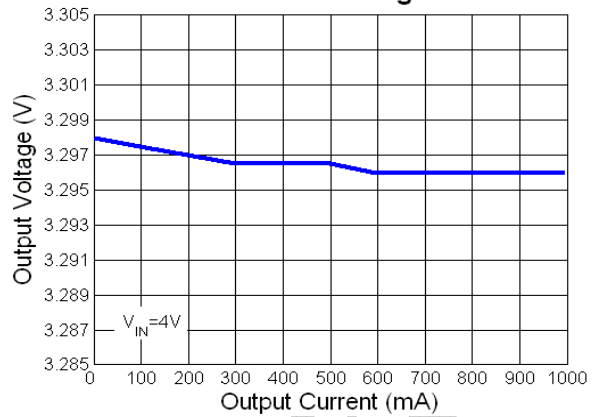

CH2 Boost SW2 and Ripple

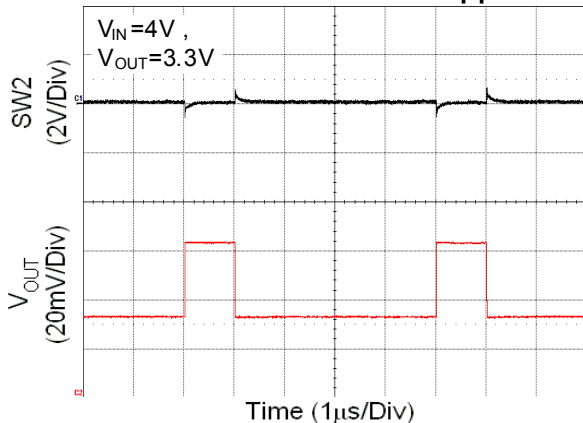

CH2 Boost Efficiency

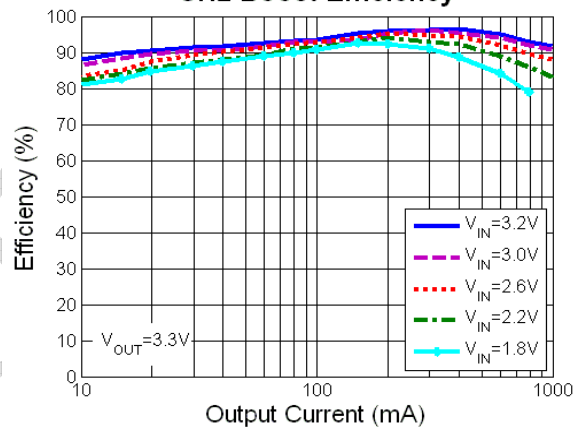

CH1 Buck Line Regulation

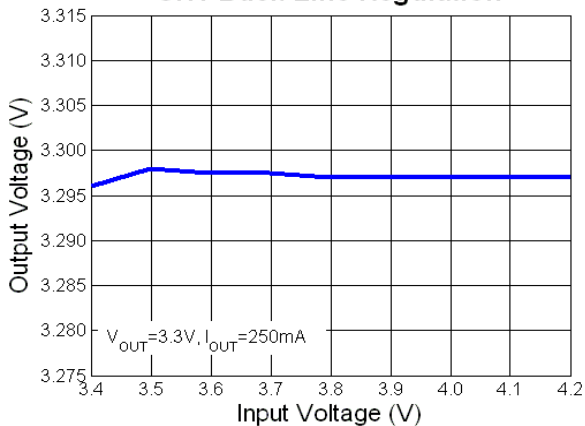

CH1 Buck Load Transient Response

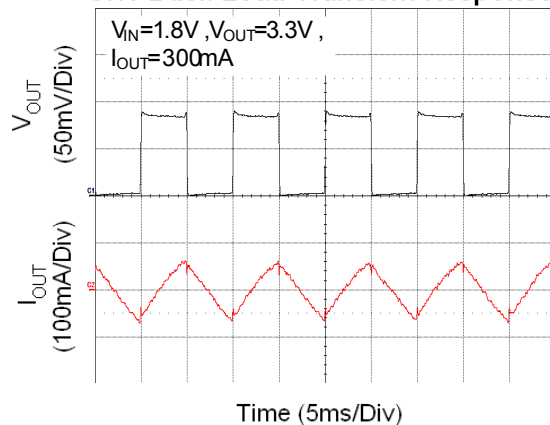



AAT1415/AAT1415A

TYPICAL OPERATING CHARACTERISTICS

CH2 Boost Load Transient Response

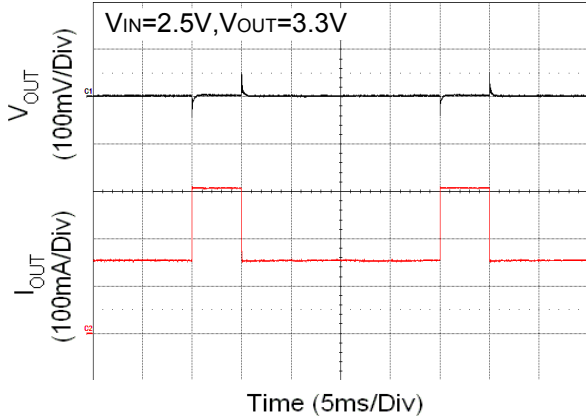

CH2 Buck Efficiency

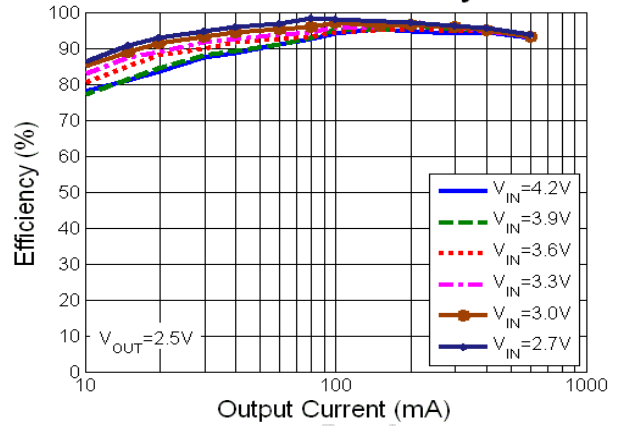

CH2 Boost Line Regulation

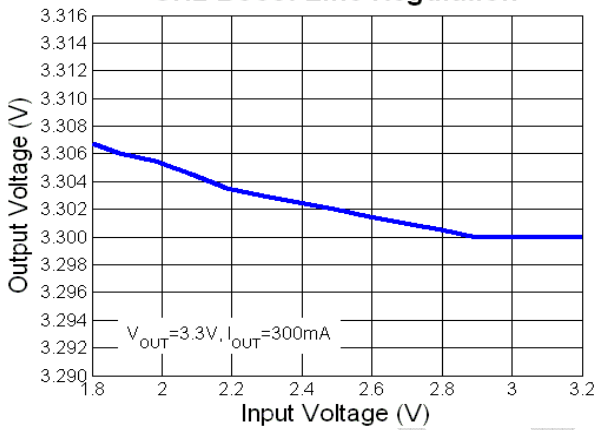

CH2 Buck SW2 and Ripple

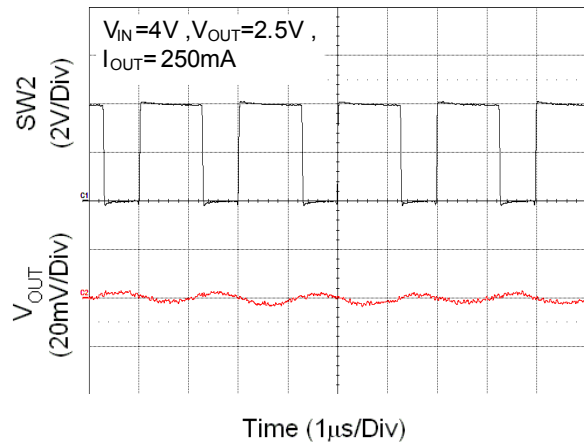

CH2 Boost Load Regulation

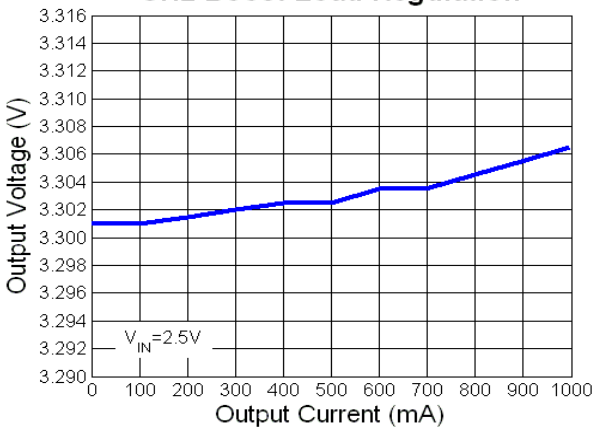

CH2 Buck Load Transient Response

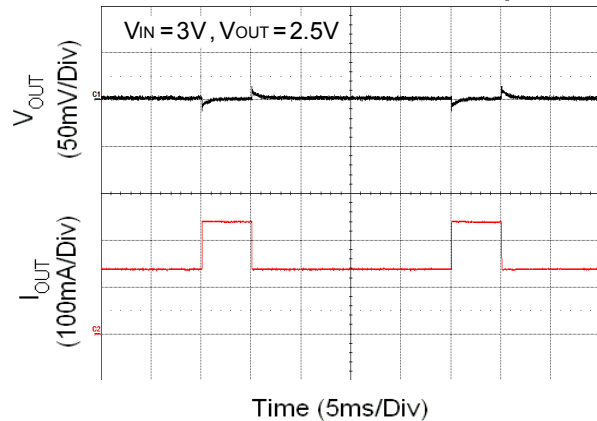



TYPICAL OPERATING CHARACTERISTICS

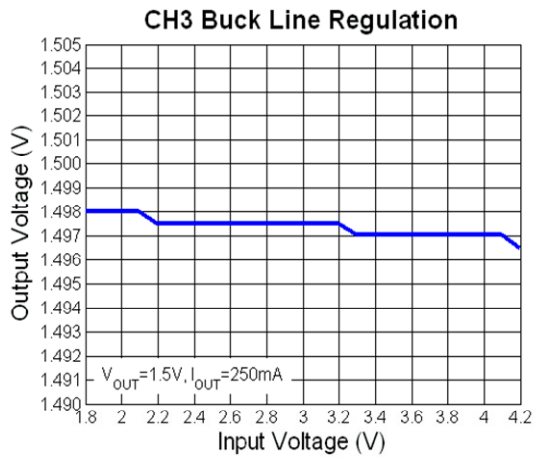
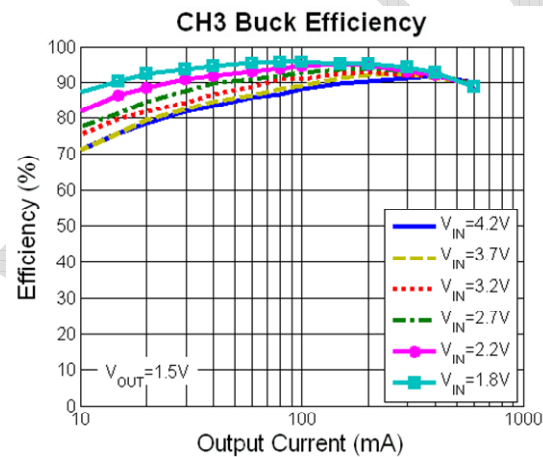
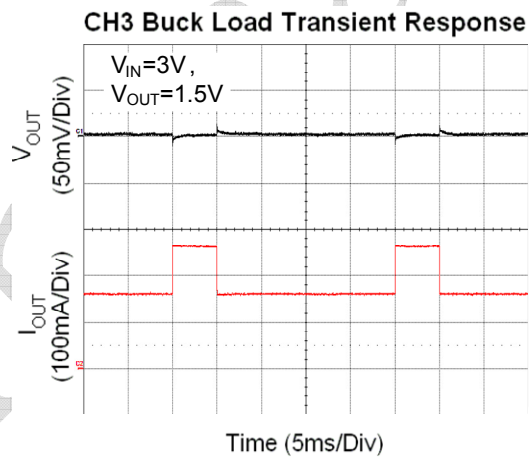
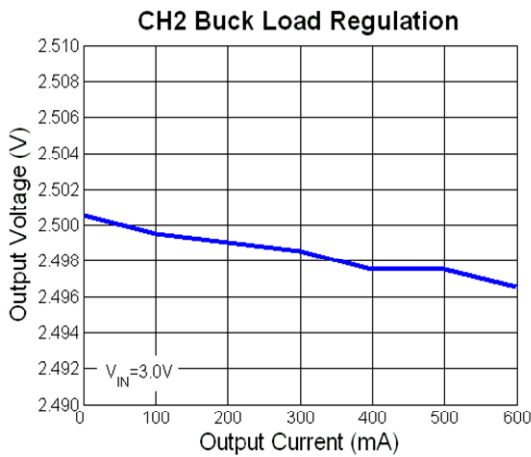
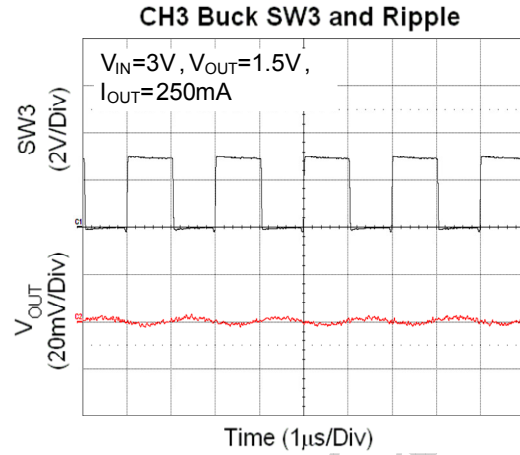
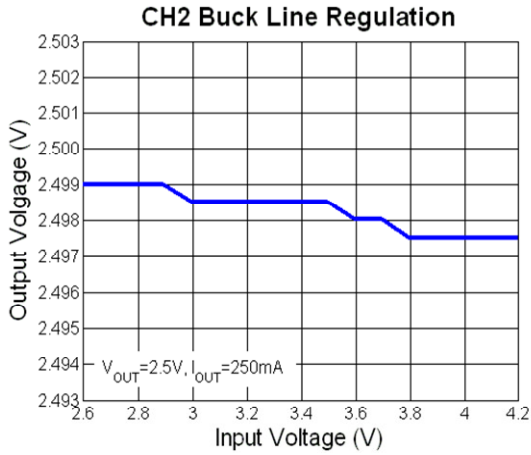



TYPICAL OPERATING CHARACTERISTICS

CH3 Buck Load Regulation

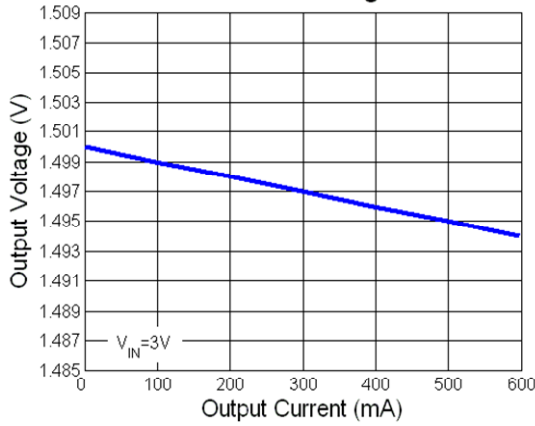

CH4 Boost Load Transient Response

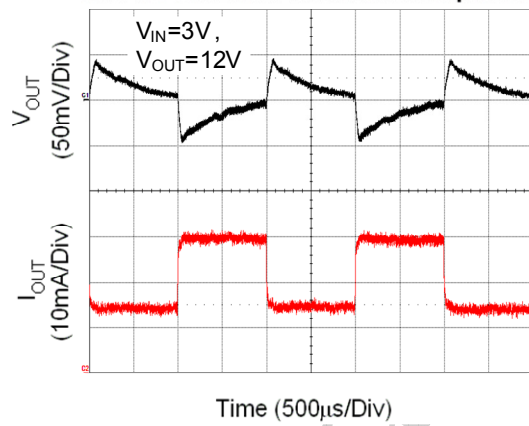

CH4 Boost Efficiency

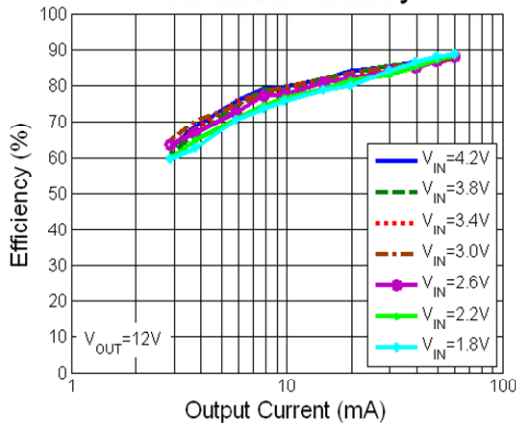

CH4 Boost Line Regulation

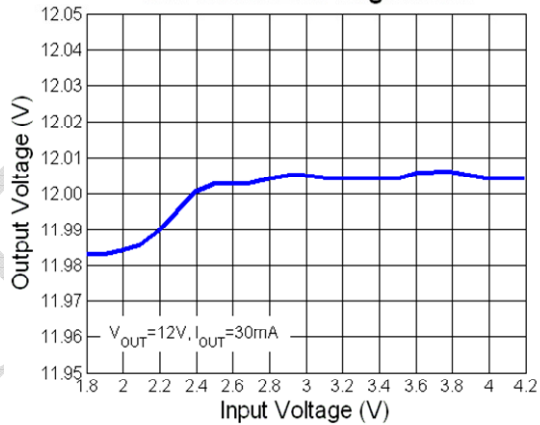

CH4 Boost OUT4 and Ripple

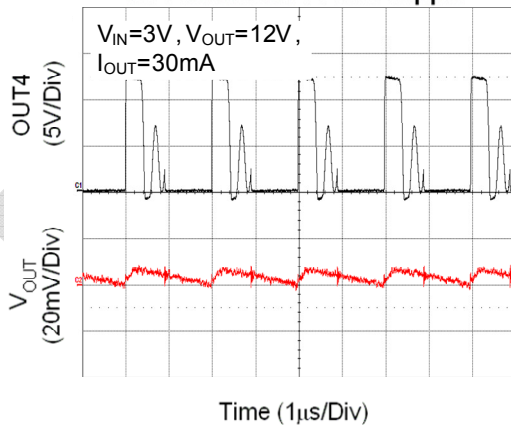

CH4 Boost Load Regulation

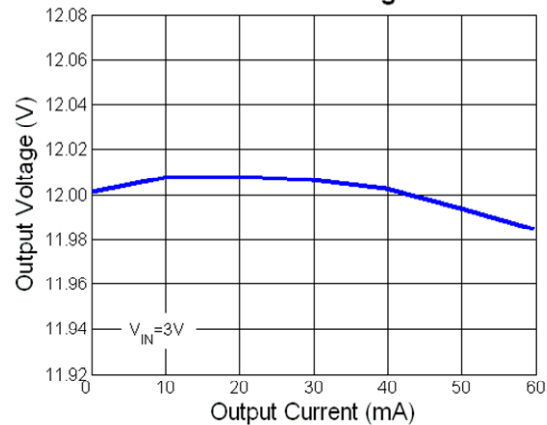



TYPICAL OPERATING CHARACTERISTICS

CH5 Inverting Efficiency

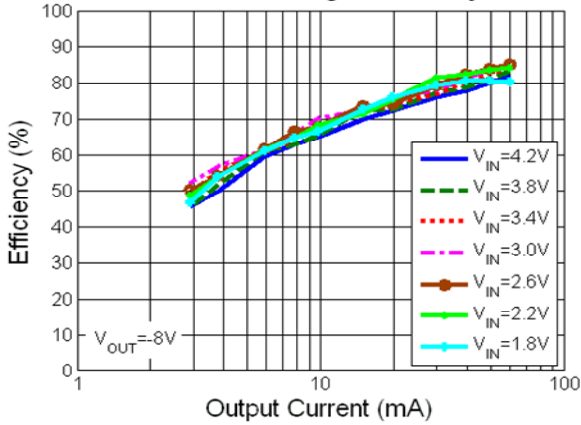

CH5 Inverting Line Regulation

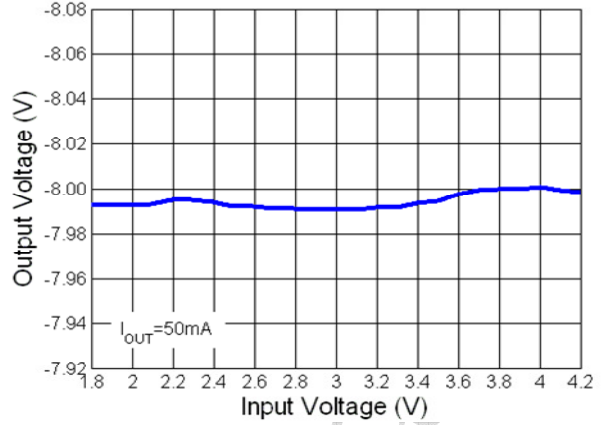

CH5 Inverting OUT5 and Ripple

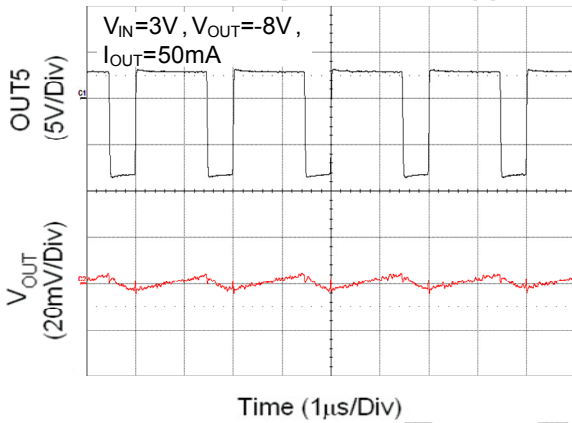

CH5 Inverting Load Regulation

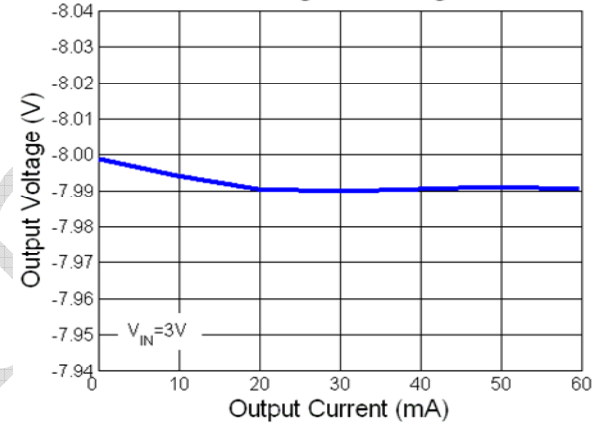

CH5 Inverting Load Transient Response

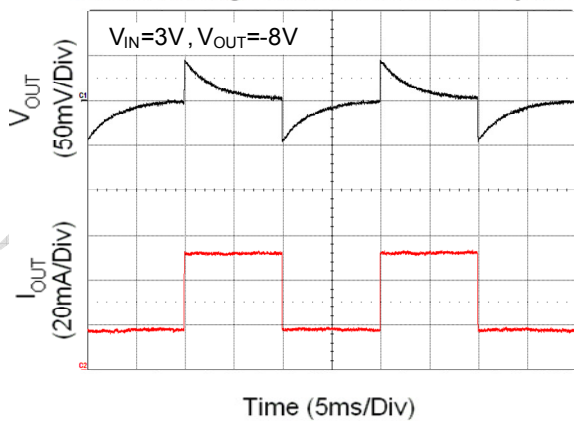

2.5V LDO Line Regulation

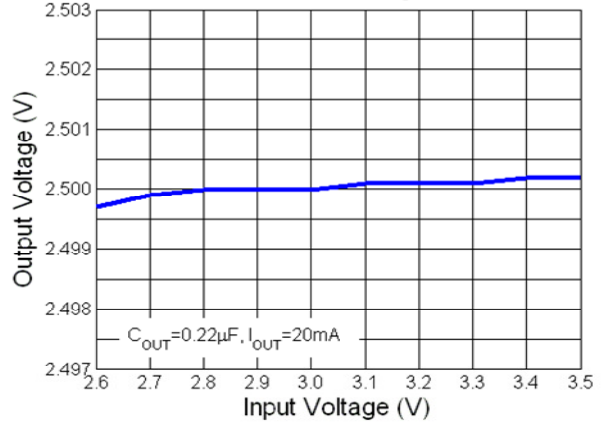

**PIN DESCRIPTION**

| PIN NO | NAME | I/O | FUNCTION |
|--------|-------|-----|--|
| 1 | EN3 | I | ON/OFF Control for CH3 |
| 2 | IN3 | I | CH3 Feedback Input |
| 3 | EO3 | I/O | CH3 Compensation Node |
| 4 | OUT3 | I | CH3 Switching Power Input |
| 5 | SW3 | I/O | CH3 Switching Node |
| 6 | GND3 | - | CH3 Power Ground |
| 7 | GND1 | - | CH1 Power Ground |
| 8 | SW1 | I/O | CH1 Switching Node |
| 9 | OUT1 | I/O | Switching Power Input (Boost) / Output (Buck) of CH1 |
| 10 | SEL1 | I | Configures CH1 as a Buck or a Boost Converter |
| 11 | EO1 | I/O | CH1 Compensation Node |
| 12 | IN1 | I | CH1 Feedback Input |
| 13 | EN1 | I | ON/OFF Control for CH1 |
| 14 | VREF | O | Reference Output |
| 15 | OSC | I/O | Oscillator Control |
| 16 | C4RDY | O | Power-Ok Signal for CH4 |
| 17 | C3RDY | O | Power-Ok Signal for CH3 |
| 18 | TR1 | I/O | CH1 Feedback Resistor Truly Shutdown Input |
| 19 | SEL2 | I | Configures CH2 as a Buck or a Boost Converter |
| 20 | EN2 | I | ON/OFF Control for CH2 |
| 21 | IN2 | I | CH2 Feedback Input |
| 22 | EO2 | I/O | CH2 Compensation Node |
| 23 | OUT2 | I | CH2 Switching Power Input |
| 24 | SW2 | I/O | CH2 Switching Node |
| 25 | GND2 | - | CH2 Power Ground |
| 26 | V2P5 | O | 2.5V LDO Output |
| 27 | VDDC | I | LDO Power Input |

**AAT1415/AAT1415A**

| | | | |
|----|------|-----|-------------------------------|
| 28 | GNDC | - | LDO Ground |
| 29 | EN5 | I | ON/OFF Control for CH5 |
| 30 | IN5 | I | CH5 Feedback Input |
| 31 | EO5 | I/O | CH5 Compensation Node |
| 32 | VDD5 | I | CH5 Power Source |
| 33 | OUT5 | O | CH5 Gate-Drive Output |
| 34 | GND | - | Internal Circuit Ground |
| 35 | IN4 | I | CH4 Feedback Input |
| 36 | EO4 | I/O | CH4 Compensation Node |
| 37 | EN4 | I | ON/OFF Control for CH4 |
| 38 | OUT4 | I/O | CH4 Gate-Drive Output |
| 39 | GND4 | - | CH4 Power Ground |
| 40 | VDD | I | Internal Circuit Power Source |



AAT1415/AAT1415A

FUNCTION BLOCK DIAGRAM

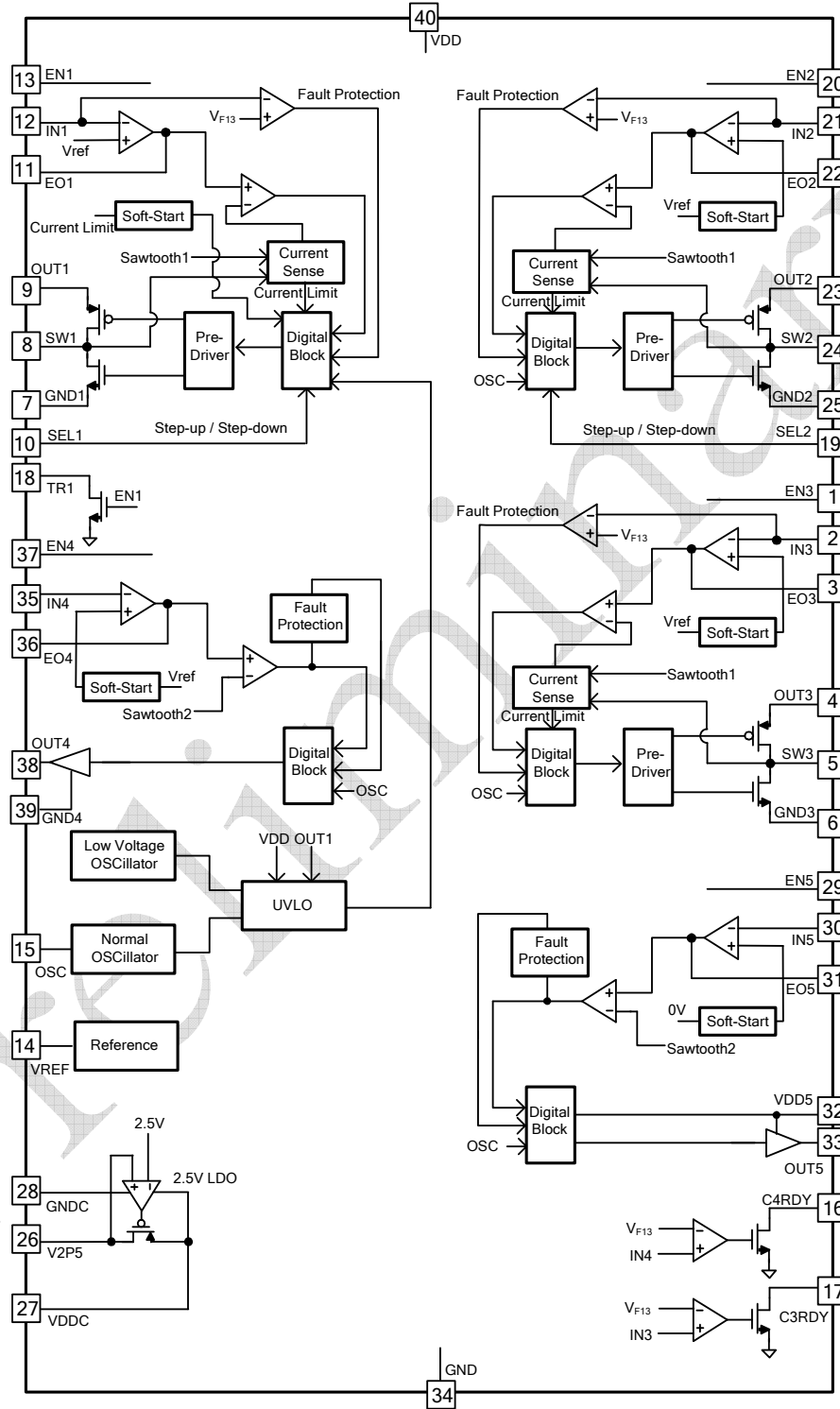



AAT1415/AAT1415A

TYPICAL APPLICATION CIRCUIT

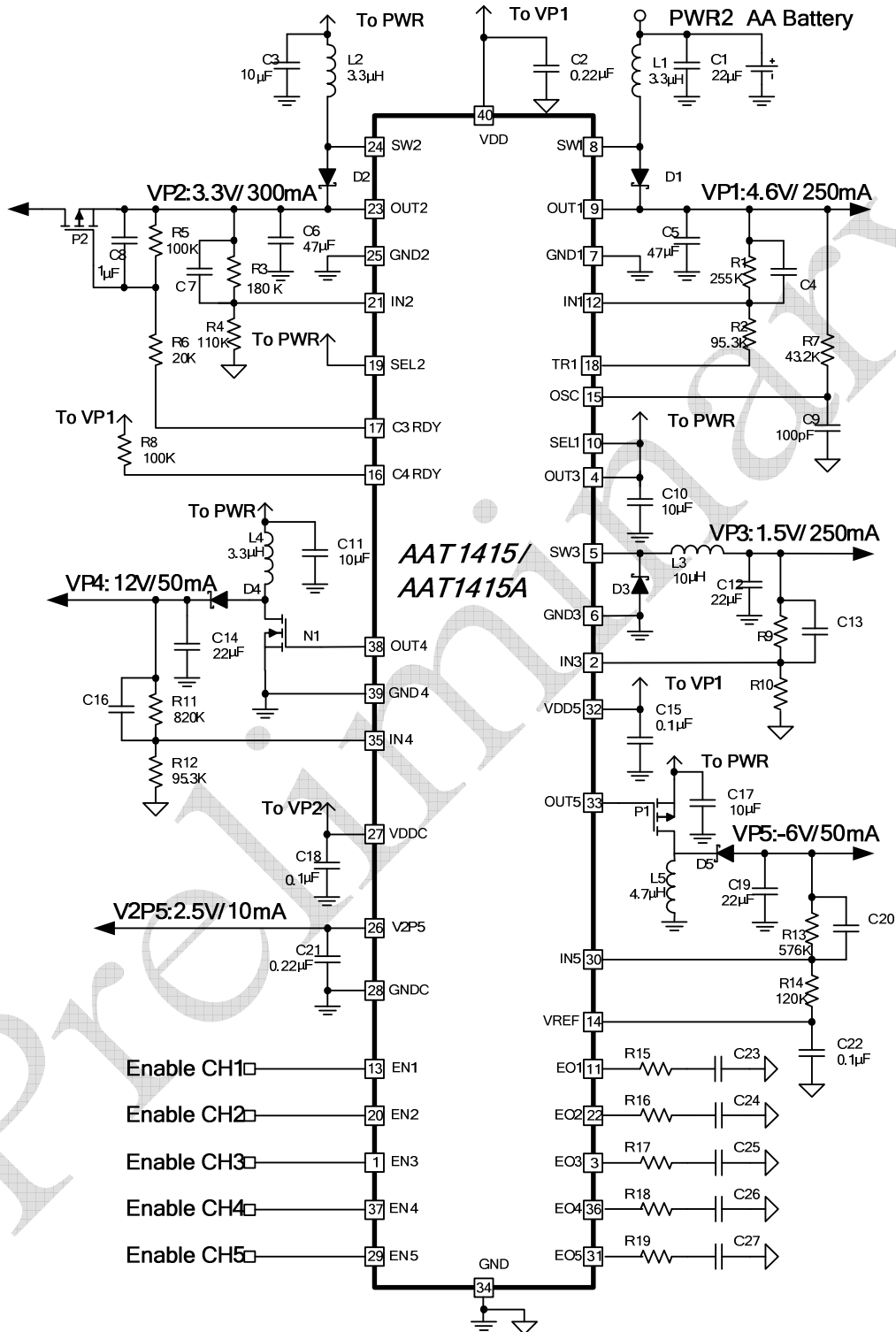

Figure 1. Typical 2-Cell AA-Powered System



AAT1415/AAT1415A

TYPICAL APPLICATION CIRCUIT

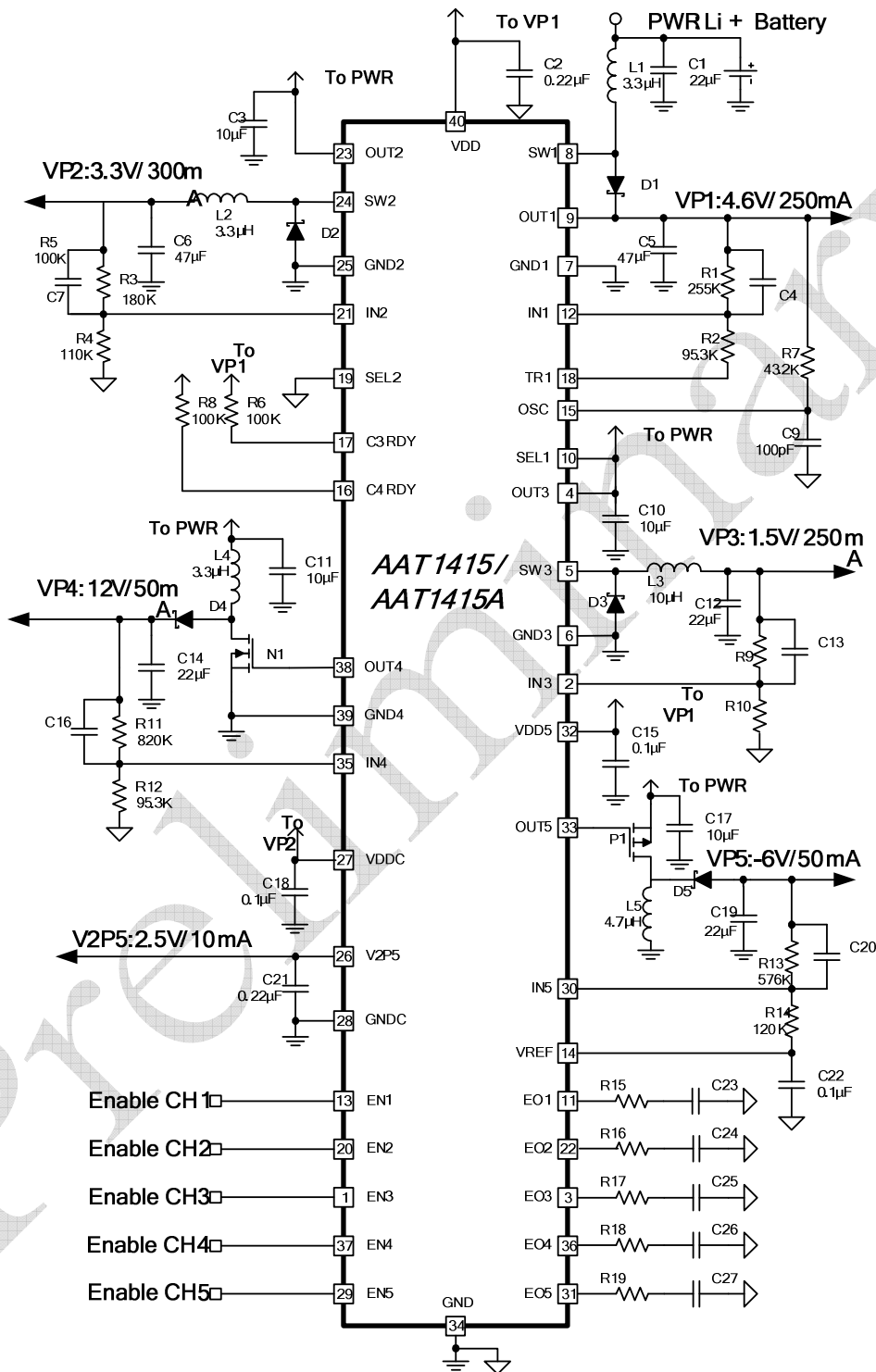

Figure 2. Typical 1-Cell Li+ Powered System (For CCD)



AAT1415/AAT1415A

TYPICAL APPLICATION CIRCUIT

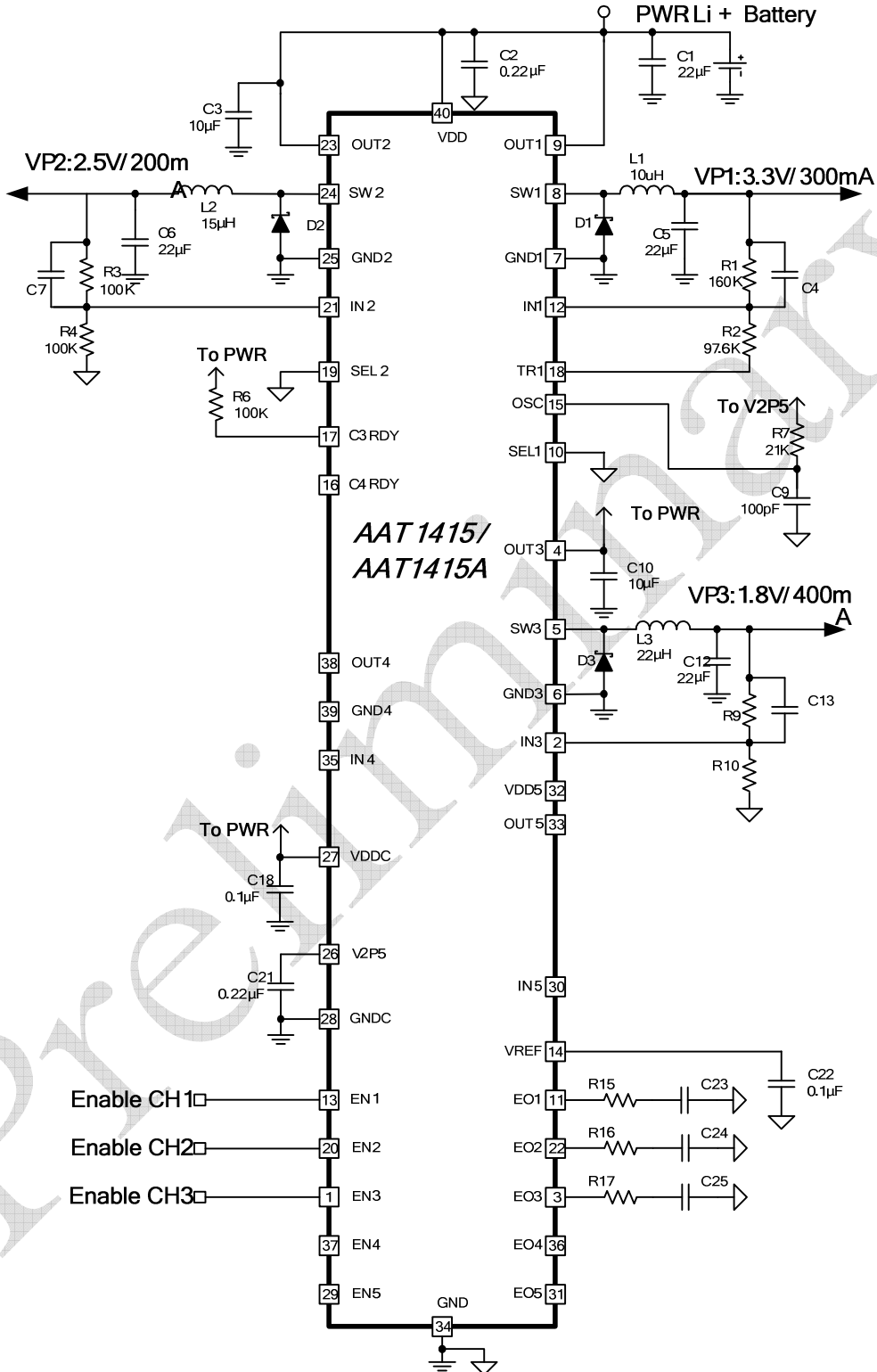

Figure 3. Typical 1-Cell Li+ Powered System (For CMOS)



AAT1415/AAT1415A

DETAILED DESCRIPTION

The AAT1415/AAT1415A is a complete power-conversion IC for digital still cameras. It can accept input from a variety of sources, including single-cell Li+ batteries and 2-cell alkaline or NiMH batteries. The AAT1415/AAT1415A includes five DC-DC converter channels and a 2.5V LDO to generate all required voltages:

- ◆ Synchronous-rectified boost or buck DC-DC converter with on-chip MOSFETs—Typically supplies 4.6V for lens motor or 3.3V for main system power.
 - ◆ Synchronous-rectified boost or Buck DC-DC converter with on-chip MOSFETs— Typically supplies 3.3V for main system power or 2.5V for DDR.
 - ◆ Synchronous-rectified buck DC-DC converter with on-chip MOSFETs— Typically supplies 1.5V for the DSP core.
 - ◆ Boost controller— Typically used for positive voltage to bias one or more of the LCD, CCD, and LED backlights.
 - ◆ Inverter controller— Typically supplies negative CCD bias when high current is needed for large pixel-count CCDs.
 - ◆ 2.5V LDO— Typically supplies 2.5V for analog-to-digital converter's reference voltage.
- The AAT1415/AAT1415A includes three versatile status outputs that can provide information to the system. All are open-drain outputs and can directly drive MOSFET switches to facilitate sequencing, disconnect loads during overloads, or perform other hardware-based functions.

TR1

TR1 pulls low when EN1 pulls high. A typical use for TR1 is to reduce CH1 boost feedback network's leakage current when CH1 is disabled (Figure 1).

C3RDY

C3RDY pulls low when IN3 reaches V_{F13} (1.1V typ). C3RDY goes high impedance in shutdown, overload, and thermal limit when IN3 is under V_{F13} . A typical use for C3RDY is to enable 3.3V power to the CPU I/O after the CPU core is powered up (Figure 1), thus providing safe sequencing in hardware without system intervention.

C4RDY

C4RDY pulls low when IN4 reaches V_{F13} (1.1V typ). C4RDY goes high impedance in shutdown, overload, and thermal limit when IN4 is under V_{F13} . A typical use for C4RDY is to drive a PMOS that gates 5V power to the CCD until the VH CCD bias (generated by CH4) is powered up (Figure 4).

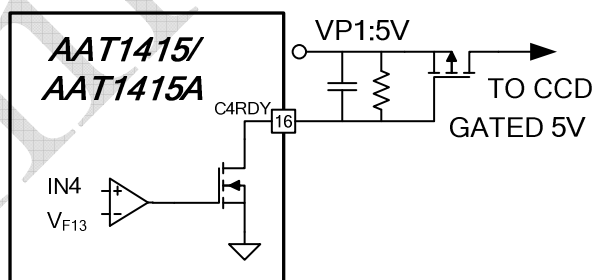

Figure 4. C4RDY Application Circuit

Soft-Start

The AAT1415/AAT1415A channels feature a soft-start function that limits inrush current and prevent excessive battery loading at startup by ramping the output voltage of each channel up to the regulation voltage.

This is accomplished by ramping the internal reference inputs to mostly channel error amplifier from 0V to the 1.25V reference voltage (CH5 from 1.25V to 0V) over a period of 4,096 oscillator cycles (16ms at 500kHz) when initial power is applied or when a channel is enabled. Soft-start of CH1 is different from others in order to avoid limiting startup capability with loading.



AAT1415/AAT1415A

See Figure 6. soft-start mechanism. CH3 soft-start ramp takes half the time (2,048 clock cycles) of the other channel ramps. This allows the CH3 and CH2 output (when set to 3.3V) to track each other and rise at nearly the same dV/dt rate on power-up. Once the step-down output reaches its regulation point (1.5V or 1.8V typ), the CH2 output (3.3V typ) continues to rise at the same ramp rate. See Figure 7 timing chart of soft-start.

2.5V LDO

The 2.5V LDO regulates the VDDC voltages when the reference voltage (VREF) is ready and VDDC voltage is greater than 2.5V.

Fault Protection

If any DC-DC converter channel remains faulted for 100,000 clock cycles (200ms at 500kHz), then all outputs latch off until the AAT1415/AAT1415A is reinitialized or by cycling the input power. The fault-detection circuitry for any channel is disabled during its initial turn-on soft-start sequence. An exception to the standard fault behavior is that there is no 100,000 clock-cycle delay in entering the fault state if the OUT1 pin is dragged below its 2.5V UVLO1 threshold or is shorted. The UVLO1 immediately triggers and shuts down all channels. The CH1 then continues to attempt to start. If the CH1 output short remains, these attempts do not succeed since OUT1 remains near ground. If a soft-short or overload remains on OUT1, the startup oscillator switches the internal NMOS, but fault is retriggered if regulation is not achieved by the end of the soft-start interval. If OUT1 is dragged below the input, the overload is supplied by the body diode of the internal synchronous rectifier or by a Schottky diode connected from the battery to OUT1.

Reference

Connect a 0.1µF ceramic bypass capacitor from VREF to GND. VREF is enabled when EN1, EN2 or EN3 is high. The AAT1415/AAT1415A has internal 1.250V references.

Oscillator

The AAT1415/AAT1415A operating frequency is set by an RC network (R_{OSC}, C_{OSC}) at the OSC pin. The range of usable settings is 100kHz to 1MHz. The oscillation frequency changes as the forced voltage (V_{OSC}) ramps upward following startup. The oscillation frequency is then constant once the main output is in regulation. At the beginning of a cycle, the timing capacitor charge through the resistor until it reaches VREF. The charge time, t₁, is as follows:

$$t_1 \approx -R_{OSC} \times C_{OSC} \times \ln\left(1 - \frac{1.25}{V_{OSC}}\right)$$

The capacitor voltage then decays to zero over time t₂ ≈ 150ns. Choose C_{OSC} between 47pF and 330pF. Determine R_{OSC} and V_{OSC}. The oscillator frequency is as follows:

$$f_{OSC} \approx \frac{1}{t_1 + t_2}$$

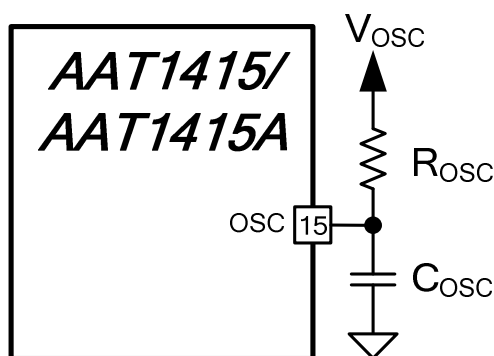

Figure 5. Oscillator Circuit

AAT1415/AAT1415A

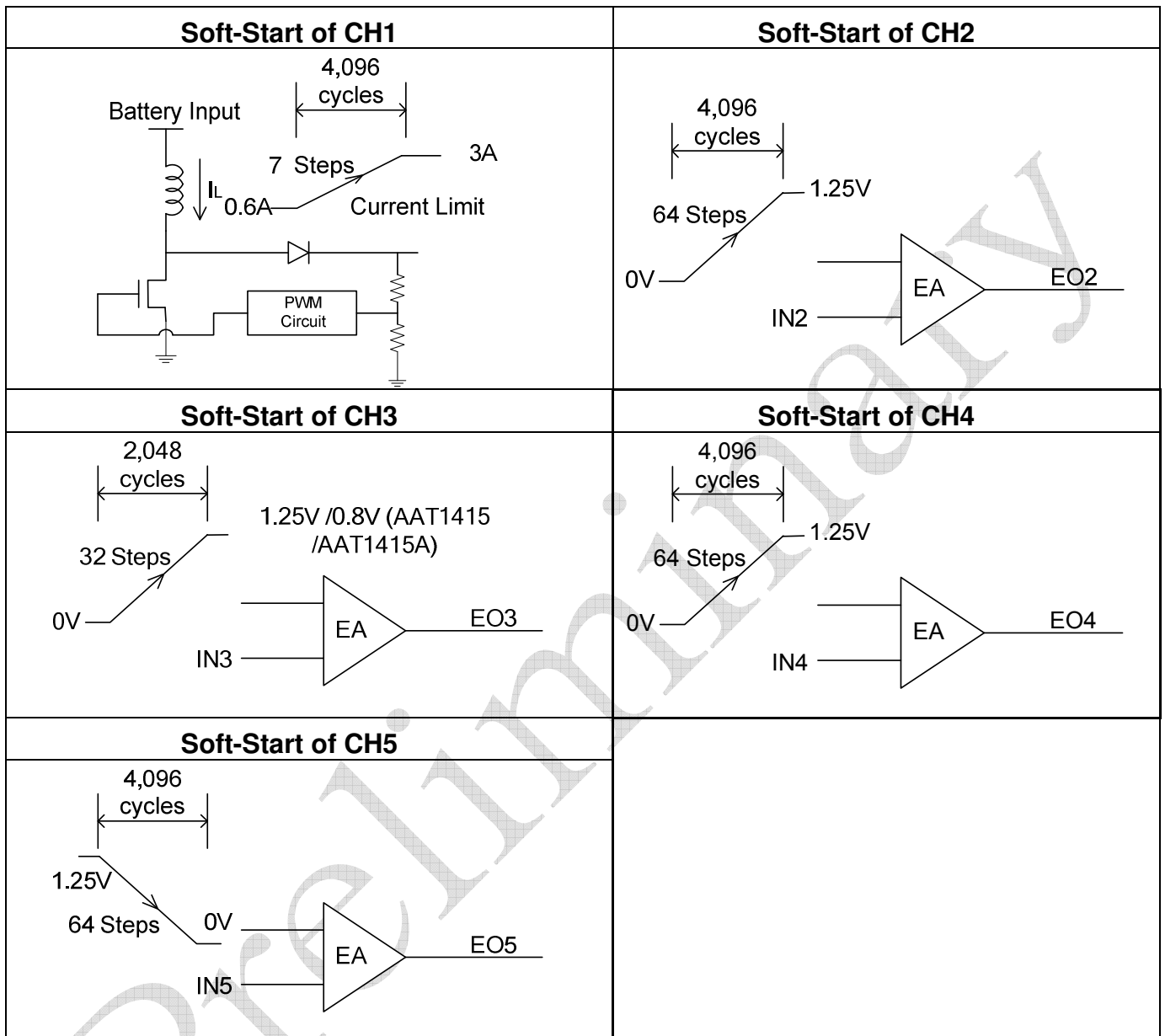

Figure 6. Soft-Start Mechanism



Soft Start Waveform

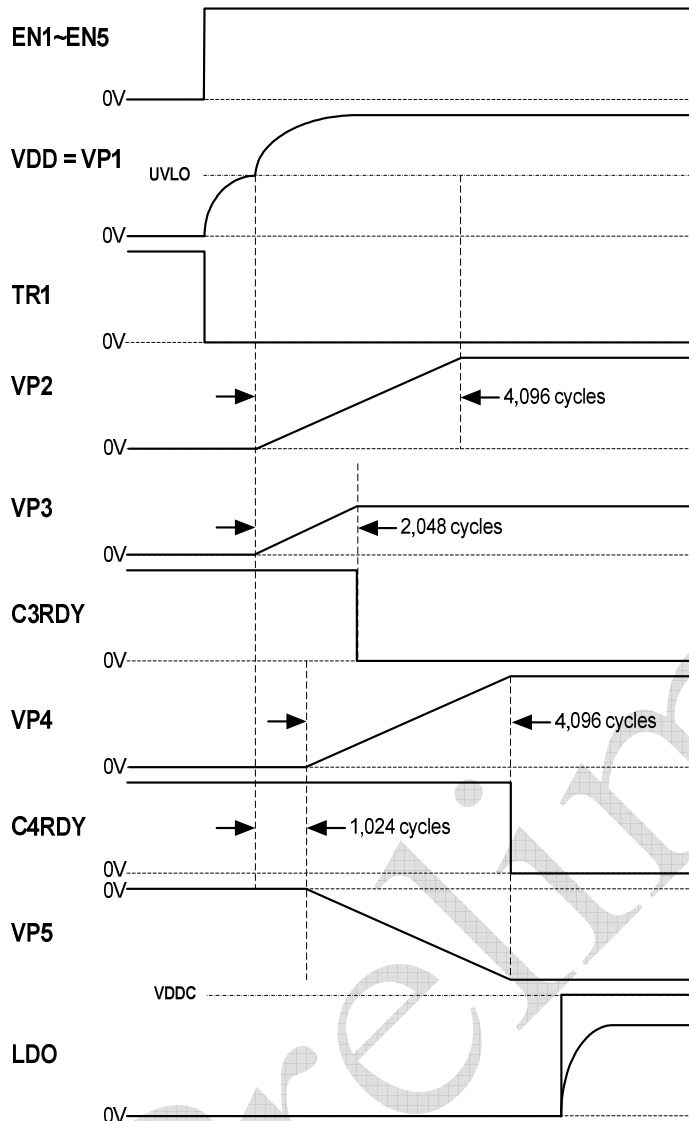

Figure 7. Timing Chart of Soft-Start

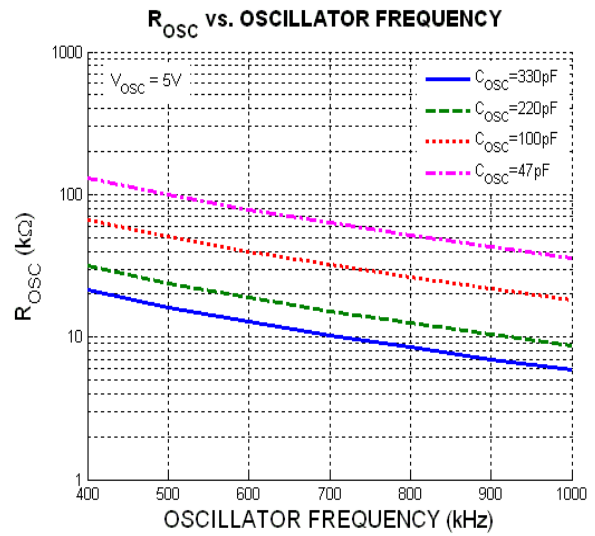

Figure 8. Oscillator Frequency

Low-Voltage Startup Oscillator

The AAT1415/AAT1415A internal control and reference voltage circuitry receives power from VDD and do not function when VDD is less than 2.5V. To ensure low voltage startup, the CH1 employs a low-voltage startup oscillator (about 200kHz) that activates at 1.2V if a Schottky diode is connected from PWR to OUT1. The startup oscillator drives the internal NMOS at SW1 until VDD reaches 2.5V, at which point voltage control is passed to the normal oscillator (current-mode PWM circuitry). At low input voltages, the CH1 can have difficulty starting into heavy loads.

AAT1415/AAT1415A

DESIGN PROCEDURE

Programming the Output Voltage

The output voltage for each channel is programmed using a resistor divider from the output connected to the feedback pins. When setting the output voltage, connect a resistive voltage divider from the channel output to the corresponding IN_ input and then to GND. Choose the lower-side (IN_-to-GND) resistor, then calculate the upper-side (output-to-IN_) resistor as follows:

$$R_{UPPER_} = R_{LOWER_} \left(\frac{V_{OUT_}}{V_{IN_}} - 1 \right) \text{ (For Boost / buck),}$$

$$R_{UPPER_} = R_{LOWER_} \left(\frac{-V_{OUT_}}{V_{REF}} \right) \text{ (For Inverting),}$$

Where $V_{IN_}$ is the feedback regulation voltage, 1.250V (AAT1415/AAT1415A, $V_{IN3} = 0.8V$), and typical values for $R_{LOWER_}$ are in the range of 10kΩ to 100kΩ.

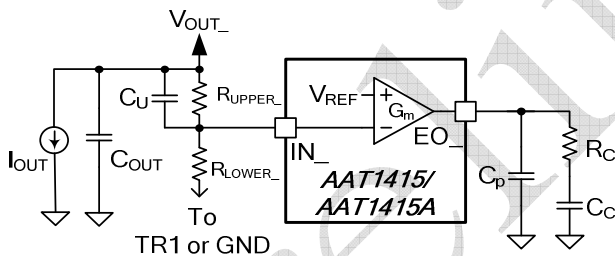

Figure 9a. Feedback Network (For Boost/Buck)

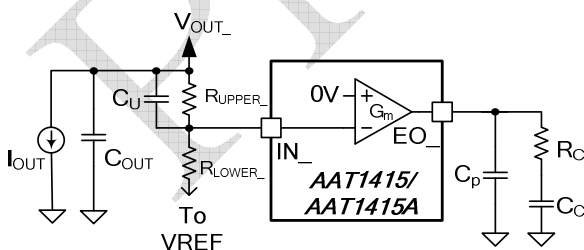

Figure 9b. Feedback Network (For Inverting)

Inductor Selection

The inductor is typically selected to operate with continuous conduction mode (CCM) for best efficiency in boost or buck converter and discontinuous conduction mode (DCM) for better response ability in boost or inverting controller (Table 1 and Table 2). The recommended inductance value range is between 2.2μH and 4.7μH for boost. The recommended inductance value range is between 6.8μH and 22μH for buck. The recommended inductance value range is between 3.3μH and 6.8μH for Inverting. With the chosen inductance value, the peak current for the inductor in steady state operation can be calculated (Table 3). It also needs to be taken into account that load transients and error conditions may cause higher inductor currents. This also needs to be taken into account when selecting an appropriate inductor.

Table 1. Response Ability for Various Topologies

| Topology | Response Ability |
|--------------------|------------------------------|
| Boost or Inverting | $\frac{V_{IN}}{L}$ |
| Buck | $\frac{V_{IN} - V_{OUT}}{L}$ |

V_{IN} : Input Voltage, V_{OUT} : Output Voltage,
 L : Inductance, Response Ability Unit: $\frac{mA}{\mu s}$

Table 2. DCM/CCM Critical Inductance Values

| Topology | D | DCM/CCM |
|-----------|--|---|
| Boost | $1 - \frac{V_{OUT}}{V_{IN}}$ | $\frac{R_{LOAD} \cdot D \cdot (1-D)^2}{2 \cdot f_{SW}}$ |
| Buck | $\frac{V_{OUT}}{V_{IN}}$ | $\frac{(1-D) \cdot R_{LOAD}}{2 \cdot f_{SW}}$ |
| Inverting | $\frac{ V_{OUT} }{ V_{OUT} + V_{IN}}$ | $\frac{R_{LOAD} \cdot (1-D)^2}{2 \cdot f_{SW}}$ |

V_{IN} : Input Voltage, V_{OUT} : Output Voltage,
 R_{LOAD} : Loading, f_{SW} : Switch Frequency,
 Inductance Unit: Henry



AAT1415/AAT1415A

Table 3. Inductor Peak Current

| Topology | Mode | Peak Current |
|-----------|------|---|
| Boost | CCM | $\frac{I_O}{(1-D)} + \frac{\Delta I_L}{2},$ $\Delta I_L = \frac{V_{OUT} \cdot D \cdot (1-D)}{f_{SW} \cdot L},$ $D = 1 - \frac{V_{IN}}{V_{OUT}}$ |
| | DCM | $\sqrt{\frac{2 \cdot (V_{OUT} - V_{IN}) \cdot I_O}{L \cdot f_{SW}}}$ |
| Buck | CCM | $I_O + \frac{\Delta I_L}{2},$ $(\Delta I_L = \frac{V_{OUT} \cdot (1-D)}{f_{SW} \cdot L},$ $D = \frac{V_{OUT}}{V_{IN}})$ |
| | DCM | $\sqrt{\frac{2 \cdot (V_{IN} - V_{OUT}) \cdot V_{OUT} \cdot I_O}{L \cdot f_{SW} \cdot V_{IN}}}$ |
| Inverting | CCM | $I_O + \frac{\Delta I_L}{2}, (\Delta I_L = \frac{V_{IN} \cdot D}{f_{SW} \cdot L},$ $D = \frac{ V_{OUT} }{ V_{OUT} + V_{IN}})$ |
| | DCM | $\sqrt{\frac{2 \cdot V_{OUT} \cdot I_O}{L \cdot f_{SW}}}$ |

V_{IN} : Input Voltage, V_{OUT} : Output Voltage, I_O : Output Current, L: Inductance, f_{SW} : Switch Frequency, Peak Current Unit: Ampere

Schottky Diode Selection

Choose a Schottky diode who's maximum reverse voltage rating is greater than the value in Table 4, and who's current rating is greater than the peak inductor current.

Table 4. Diode and MOS Minimum Voltage Rating

| Topology | Minimum Voltage Rating |
|-----------|------------------------|
| Boost | V_{OUT} |
| Buck | V_{IN} |
| Inverting | $V_{IN} + V_{OUT} $ |

External MOSFET Selection

The boost controller and Inverting controller drive external logic-level MOSFETs. MOSFETs' maximum drain-to-source voltage ($V_{DS(MAX)}$) rating must be greater than the value in Table 4. Their on-resistance ($R_{DS(ON)}$), total gate charge (Q_G) and reverse transfer capacitance (C_{RSS}) are the lower the better.

Input Capacitor

The input current to converters are discontinuous, and therefore input capacitors are required to supply the AC current to converters while maintaining the DC input voltage. A low ESR capacitor is required to keep the noise at the IC to a minimum. Ceramic capacitors are preferred, but tantalum or low-ESR electrolytic capacitors may also suffice. For insuring stable operation a bypass ceramic 0.1μF capacitor should be placed as close to the IC VDD pin as possible.

Output Capacitor

The output capacitor is required to maintain the DC output voltage. Low ESR capacitors are preferred to keep the output voltage ripple low. The characteristics of the output capacitor also affect the stability of the regulation control system. Ceramic, tantalum, or low ESR electrolytic capacitors are recommended. In the case of ceramic capacitors, the impedance at the switching frequency is dominated by the capacitance, and so the output voltage ripple is mostly independent of the ESR. The output voltage ripple is estimated to be:

$$V_{RIPPLE} \approx \frac{\Delta I_L}{2\pi \times f_{SW} \times C_{OUT}}$$



Where V_{RIPPLE} is the output ripple voltage, ΔI_L is the inductor ripple current, f_{SW} is the switching frequency and C_{OUT} is the output capacitance. In the case of tantalum or low-ESR electrolytic capacitors, the ESR dominates the impedance at the switching frequency, and so the output ripple is calculated as:

$$V_{\text{RIPPLE}} \approx \Delta I_L \times R_{\text{ESR}}$$

Where V_{RIPPLE} is the output voltage ripple, ΔI_L is the inductor ripple current, and R_{ESR} is the equivalent series resistance of the output capacitors.

Boost Converter Compensation

The compensation resistor and capacitor (Figure 9a) are chosen to optimize control-loop stability. The boost converter employs current-mode control, thereby simplifying the control-loop compensation. When the converter operates with continuous conduction mode (typically the case), a right-half-plane zero appears in the loop-gain frequency response. To ensure stability, the cross over frequency (f_C) should be much less than that of the right-half-plane zero.

For CCM, the right-half-plane zero frequency (f_{RHPZ}) is given by the following:

$$f_{\text{RHPZ}} = \frac{V_{\text{OUT}_-} \times (1-D)^2}{2\pi \times L \times I_{\text{LOAD}}}$$

Typically target cross over frequency (f_C) is the value for 1/6 of the RHPZ. Choose f_C , and then calculate compensation capacitor (C_C) as follows:

$$C_C = \frac{V_{\text{IN}_-}}{R_{\text{CS}}} \times \frac{G_m}{2\pi \cdot f_C} \times \frac{(1-D)}{I_{\text{LOAD}}}$$

Where V_{IN_-} is the feedback regulation voltage, 1.25V (typ), R_{CS} is the current-sense amplifier transresistance, 0.25V/A (typ), G_m is the error amplifier transconductance, 70 μ S (typ). Select R_C based on the allowed transient-droop (TD%) requirements by the

following equation:

$$R_C = I_{L(\text{PK})} \times \frac{R_{\text{CS}}}{\text{TD}\% \times V_{\text{IN}_-} \times G_m}$$

Where $I_{L(\text{PK})}$ is the inductor peak current.

The output filter capacitor (typically ceramic capacitor) is then chosen to cancel the $R_C C_C$ zero:

$$C_{\text{OUT}} = \frac{I_{\text{LOAD}}}{V_{\text{OUT}_-}} \times R_C C_C$$

If the output filter capacitor (typically electrolytic capacitor) has significant equivalent series resistance (ESR), a zero occurs at the following:

$$Z_{\text{ESR}} = \frac{1}{2\pi \times C_{\text{OUT}} \times R_{\text{ESR}}}$$

If $Z_{\text{ESR}} \gg f_C$, it can be ignored. If Z_{ESR} is less than f_C , it should be cancelled with a pole set by capacitor C_P connected from EO_- to GND:

$$C_P = \frac{C_{\text{OUT}} \times R_{\text{ESR}}}{R_C}$$

If the system wants better transient response, it can parallel a capacitor C_U with R_{UPPER_-} from IN_- to V_{OUT_-} :

$$C_U = \frac{1}{2\pi \times R_{\text{UPPER}_-} \times f_C \times \left(\frac{V_{\text{IN}_-}}{V_{\text{OUT}_-}} \right)}$$

If C_P or C_U is calculated to be less than 10pF, it can be omitted. Additionally, C_P or C_U can suppress the inrush current.

So, for a 3.3V/250mA output with $V_I = 2.0\text{V}$, $L = 3.5\mu\text{H}$, $R_{\text{UPPER}_-} = 164\text{k}$, $f_{\text{SW}} = 500\text{kHz}$ and transient-droop 5%:



$$C_C = \frac{1.25V}{0.25V/A} \times \frac{70\mu A/V}{2\pi \cdot 35kHz} \times \frac{(1-0.39)}{250mA} \approx 3.3nF,$$

$$R_C = 0.64 \times \frac{0.25V/A}{0.05 \times 1.25 \times 70\mu A/V} \approx 36k\Omega,$$

$$C_{OUT} = \frac{250mA}{3.3V} \times 36k\Omega \times 3.3nF \approx 10\mu F$$

When the C_{OUT} value is two to three times greater than what's calculated above, better output voltage ripple can be achieved.

$$C_U = \frac{1}{2\pi \times 164k\Omega \times 35kHz \times (1.25V/3.3V)} \approx 100pF$$

Buck Converter Compensation

The buck converter employs current-mode control, thereby simplifying the control-loop compensation. When the buck converter operates with continuous inductor current (typically the case), a $R_{LOAD} C_{OUT}$ pole appears in the loop-gain frequency response. To ensure stability, set the compensation $R_C C_C$ (Figure 9a) to zero to compensate for the $R_{LOAD} C_{OUT}$ pole. Then set the loop crossover frequency below 1/5 of the switching frequency. The compensation resistor and capacitor are then chosen to optimize control-loop stability.

Choose the compensation capacitor C_C to set the desired crossover frequency f_C . Determine the value by the following equation:

$$C_C = \frac{V_{IN_}}{I_{LOAD} \times R_{CS}} \times \frac{G_m}{2\pi \cdot f_C}$$

where $V_{IN_}$ is the feedback regulation voltage, 1.25V (typ), R_{CS} is the current-sense amplifier transresistance, 0.5V/A (typ), G_m is the error amplifier transconductance, 70 μ S (typ). Select R_C based on the allowed transient-droop (TD%) requirements by the following

equation:

$$R_C = I_{L(PK)} \times \frac{R_{CS}}{TD\% \times V_{IN_} \times G_m}$$

Where $I_{L(PK)}$ is the inductor peak current.

The output filter capacitor (typically ceramic capacitor) is then chosen to cancel the $R_C C_C$ zero:

$$C_{OUT} = \frac{I_{LOAD}}{V_{OUT_}} \times R_C C_C$$

If the output filter capacitor (typically electrolytic capacitor) has significant equivalent series resistance (ESR), a zero occurs at the following:

$$Z_{ESR} = \frac{1}{2\pi \times C_{OUT} \times R_{ESR}}$$

If $Z_{ESR} \gg f_C$, it can be ignored. If Z_{ESR} is less than f_C , it should be cancelled with a pole set by capacitor C_P connected from EO_- to GND:

$$C_P = \frac{C_{OUT} \times R_{ESR}}{R_C}$$

If the system wants better transient response, it can parallel a capacitor C_U with $R_{UPPER_}$ from IN_- to $V_{OUT_}$:

$$C_U = \frac{1}{2\pi \times R_{UPPER_} \times f_C \times \left(\frac{V_{IN_}}{V_{OUT_}} \right)}$$

If C_P or C_U is calculated to be less than 10pF, it can be omitted.

So, for a 1.5V/250mA output with $V_I = 3.0V$, $L = 10\mu H$, $R_{UPPER} = 20k\Omega$, $f_{SW} = 500kHz$ and transient-droop 3%:



$$C_C = \frac{1.25V}{250mA \times 0.5V/A} \times \frac{70\mu A/V}{2\pi \cdot 70kHz} \approx 2.2nF,$$

$$R_C = 0.325A \times \frac{0.5V/A}{0.03 \times 1.25 \times 70\mu A/V} \approx 68k\Omega,$$

$$C_{OUT} = \frac{250mA}{1.5V} \times 68k\Omega \times 2.2nF \approx 22\mu F,$$

$$C_U = \frac{1}{2\pi \times 20k\Omega \times 70kHz \times (1.25V/1.5V)} \approx 220pF.$$

Boost Controller Compensation

The boost controller employs voltage-mode control to regulate their output voltage. A benefit of discontinuous conduction mode (DCM) is more flexible loop compensation, better response ability and no maximum duty-cycle restriction on boost ratio. When the boost converter operates with discontinuous conduction mode (typically the CCD VH case), the boost controller has a single pole at the following:

$$f_P = \frac{2 \times V_{OUT} - V_I}{2\pi \times R_{LOAD} \times C_{OUT} \times V_{OUT}}$$

Set the loop cross over frequency (f_C) below the lower of 1/10 the switching frequency (f_{SW}). Choose the compensation capacitor C_C to set the desired crossover frequency f_C . Determine the value by the following equation:

$$C_C = \frac{V_{OUT} \cdot V_I}{(2 \cdot V_{OUT} - V_I)} \times \frac{G_m}{2\pi \cdot f_C} \times \sqrt{\frac{V_{OUT}}{M \cdot (V_{OUT} - V_I)}}$$

Where:

$$M = \frac{2 \cdot L \cdot f_{SW}}{R_{LOAD}}$$

The $R_C C_C$ zero is then used to cancel the f_P pole, so:

$$R_C = \frac{V_{OUT} \cdot R_{LOAD} \cdot C_{OUT}}{(2 \cdot V_{OUT} - V_I) \cdot C_C}$$

The typical R_C is under 500k Ω .

If the system wants better transient response, it can parallel a capacitor C_U with $R_{UPPER_}$ from $IN_$ to $V_{OUT_}$:

$$C_U = \frac{1}{2\pi \times R_{UPPER_} \times f_C \times \left(\frac{V_{IN_}}{V_{OUT_}} \right)}$$

If C_U is calculated to be less than 10pF, it can be omitted. Additionally, C_U can suppress the inrush current

So, for a 13V/30mA output with $V_I = 3.0V$, $L = 3.5\mu H$, $R_{UPPER} = 100k\Omega$, $f_{SW} = 500kHz$:

$$C_C = \frac{13V \cdot 3V}{(2 \cdot 13V - 3V)} \times \frac{70\mu A/V}{2\pi \cdot 50kHz} \times \sqrt{\frac{13V}{8m \cdot (13V - 2V)}} \approx 4.7nF$$

$$R_C = \frac{13V \cdot 433\Omega \cdot 10\mu F}{(2 \cdot 13V - 3V) \cdot 4.7nF} \approx 500k\Omega,$$

$$C_U = \frac{1}{2\pi \times 100k \times 50kHz \times \left(\frac{1.25V}{13V} \right)} \approx 330pF.$$

Inverting Controller Compensation

The inverting controller also employs voltage-mode control to regulate their output voltage. To operate in discontinuous conduction mode (DCM) is preferred for simple loop compensation and freedom from duty-cycle restrictions on the inverter input-output ratio. When the Inverting converter operates with discontinuous conduction mode (typically the CCD VL case), the inverting controller has a single pole at the following:

$$f_P = \frac{1}{\pi \cdot R_{LOAD} \cdot C_{OUT}}$$



Set the loop cross over frequency (f_C) below the lower of 1/10 the switching frequency (f_{SW}). Choose the compensation capacitor C_C to set the desired crossover frequency f_C . Determine the value by the following equation:

$$C_C = \frac{V_I}{(|V_{OUT}| + V_{REF}) \cdot \sqrt{M}} \times \frac{G_m}{2\pi \cdot f_C}$$

Where:

$$M = \frac{2 \cdot L \cdot f_{SW}}{R_{LOAD}}$$

The $R_C C_C$ zero is then used to cancel the f_p pole, so:

$$R_C = \frac{R_{LOAD} \cdot C_{OUT}}{2 \cdot C_C}$$

The typical R_C is under 500k Ω .

If the system wants better transient response, it can parallel a capacitor C_U with $R_{UPPER_}$ from $IN_$ to $V_{OUT_}$:

$$C_U = \frac{1}{2\pi \times R_{UPPER_} \times f_C \times \left(\frac{V_{IN_}}{|V_{OUT_}| + V_{IN_}} \right)}$$

If C_U is calculated to be less than 10pF, it can be omitted. Additional C_U can suppress the inrush current. So, for a -7V/50mA output with $V_I = 3.0V$, $L = 4.7\mu H$, $R_{UPPER_} = 56k\Omega$, $f_{SW} = 500kHz$:

$$C_C = \frac{3V}{(|-7| + 1.25V) \cdot \sqrt{33.6m}} \times \frac{70\mu A / V}{2\pi \cdot 20kHz} \approx 2.2nF$$

$$R_C = \frac{140\Omega \cdot 10\mu F}{2 \cdot 2.2nF} \approx 300k\Omega,$$

$$C_U = \frac{1}{2\pi \times 56k\Omega \times 20kHz \times \left(\frac{V_{IN_}}{|V_{OUT_}| + V_{IN_}} \right)} \approx 1nF$$

LAYOUT CONSIDERATIONS

Conductors carrying discontinuous currents and any high-current path should be made as short and wide as possible. The compensation network should be very close to the $EO_$ pin and avoid through VIA. The IC must be bypassed with ceramic capacitors placed close to the VDD and VREF. A separate low-noise ground plane containing the reference and signal grounds should connect to the power-ground plane at only one point to minimize the effects of power-ground currents. Typically, the ground planes are best joined right at the IC. Tie the feedback resistor divider to be very close to output capacitor and far away from the inductor or Schottky diode. Keep the feedback network ($IN_$) close to the IC. Switching nodes ($SW_$) should be kept as small as possible and should be routed away from high-impedance nodes such as $IN_$.



PACKAGE DIMENSION

VQFN40 5*5

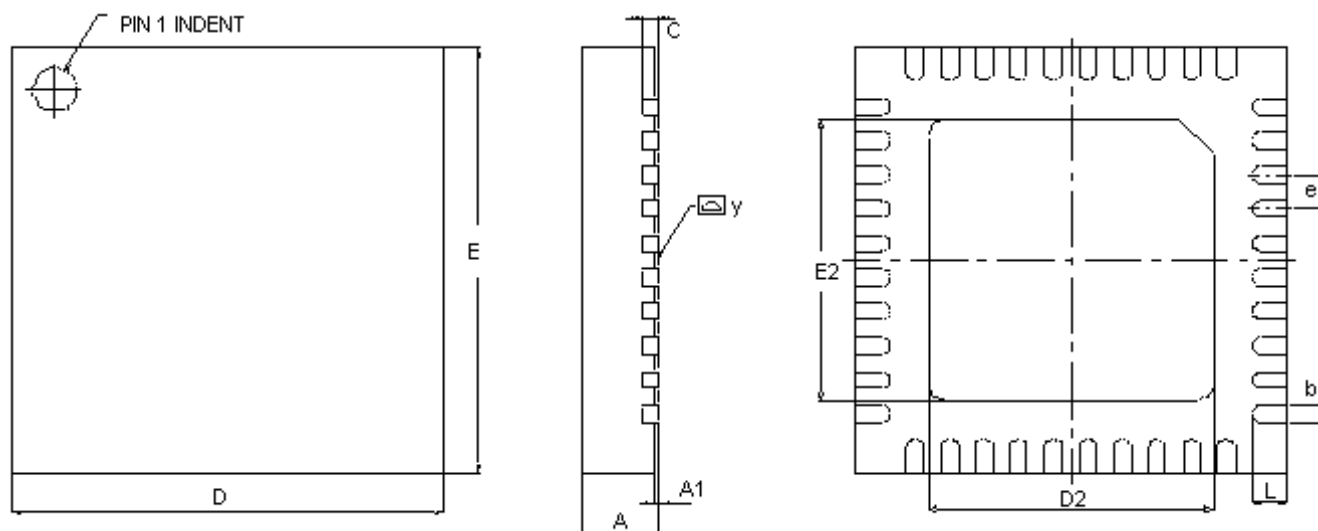

| Symbol | Dimensions In Millimeters | | |
|--------|---------------------------|-------|-------|
| | MIN | TYP | MAX |
| A | 0.8 | 0.9 | 1.0 |
| A1 | 0.00 | 0.02 | 0.05 |
| b | 0.15 | 0.20 | 0.25 |
| C | ----- | 0.2 | ----- |
| D | 4.9 | 5.0 | 5.1 |
| D2 | 3.25 | 3.30 | 3.35 |
| E | 4.9 | 5.0 | 5.1 |
| E2 | 3.25 | 3.30 | 3.35 |
| e | ----- | 0.4 | ----- |
| L | 0.35 | 0.40 | 0.45 |
| y | 0 | ----- | 0.075 |